

NINA-B1 series

Stand-alone Bluetooth low energy modules

Data sheet



Abstract

This technical data sheet describes the NINA-B1 series stand-alone Bluetooth® low energy modules. With embedded Bluetooth low energy stack and u-connectXpress software, these modules are tailored for OEMs who wish to have the shortest time-to-market. The OEMs can also embed their own application on top of the integrated Bluetooth low energy stack using Nordic SDK or Arm® Mbed™ integrated development environment (IDE).

Document information

Title	NINA-B1 series	
Subtitle	Stand-alone Bluetooth low energy modules	
Document type	Data sheet	
Document number	UBX-15019243	
Revision and date	R15	5-Aug-2021
Disclosure restriction	C1-Public	

Product status	Corresponding content status	
Functional sample	Draft	For functional testing. Revised and supplementary data will be published later.
In development / Prototype	Objective specification	Target values. Revised and supplementary data will be published later.
Engineering sample	Advance information	Data based on early testing. Revised and supplementary data will be published later.
Initial production	Early production information	Data from product verification. Revised and supplementary data may be published later.
Mass production / End of life	Production information	Document contains the final product specification.

This document applies to the following products:

Product name	Type number	u-connectXpress software version	Hardware version	PCN reference	Product status
NINA-B111	NINA-B111-00B-00	1.0.0	02	N/A	Mass production
	NINA-B111-01B-00	2.0.0	02	N/A	Mass production
	NINA-B111-02B-00	3.0.1	02	N/A	Mass production
	NINA-B111-03B-00	4.0.0	02	N/A	Mass production
	NINA-B111-04B-00	5.0.0	02	N/A	Mass production
	NINA-B111-05B-00	7.0.0	02	N/A	Initial production
NINA-B112	NINA-B112-00B-00	1.0.0	02	N/A	Mass production
	NINA-B112-01B-00	2.0.0	02	N/A	Mass production
	NINA-B112-02B-00	3.0.1	02	N/A	Mass production
	NINA-B112-03B-00	4.0.0	02	N/A	Mass production
	NINA-B112-04B-00	5.0.0	02	N/A	Mass production
	NINA-B112-05B-00	7.0.0	02	N/A	Initial production

u-blox or third parties may hold intellectual property rights in the products, names, logos and designs included in this document. Copying, reproduction, modification or disclosure to third parties of this document or any part thereof is only permitted with the express written permission of u-blox.

The information contained herein is provided "as is" and u-blox assumes no liability for its use. No warranty, either express or implied, is given, including but not limited to, with respect to the accuracy, correctness, reliability and fitness for a particular purpose of the information. This document may be revised by u-blox at any time without notice. For the most recent documents, visit www.u-blox.com.

Copyright © u-blox AG.

Contents

Document information	2
Contents	3
1 Functional description.....	6
1.1 Overview.....	6
1.2 Product features	7
1.3 Block diagram	8
1.3.1 NINA-B111	8
1.3.2 NINA-B112	8
1.4 Product description	8
1.5 Hardware options.....	9
1.6 Software options.....	9
1.6.1 u-connectXpress software	9
1.6.2 Open CPU.....	10
1.7 Bluetooth device address	10
2 Interfaces	11
2.1 Power management	11
2.1.1 Module supply input (VCC)	11
2.1.2 Digital I/O interfaces reference voltage (VCC_IO).....	11
2.2 RF antenna interfaces	11
2.2.1 2.4 GHz Bluetooth low energy (ANT)	11
2.2.2 Near Field Communication (NFC).....	11
2.3 System functions.....	12
2.3.1 Power modes	12
2.3.2 Module reset	12
2.3.3 CPU and memory	13
2.3.4 Direct Memory Access.....	13
2.3.5 Programmable Peripheral Interconnect.....	13
2.3.6 Real Time Counter (RTC).....	13
2.4 Serial interfaces	13
2.4.1 Asynchronous serial interface (UART).....	14
2.4.2 Serial peripheral interface (SPI).....	14
2.4.3 Inter-Integrated Circuit interface (I2C)	14
2.4.4 Inter-IC Sound interface (I2S)	15
2.5 Digital interfaces.....	15
2.5.1 Pulse Width Modulation (PWM)	15
2.5.2 Pulse Density Modulation (PDM).....	15
2.5.3 Quadrature Decoder (QDEC)	15
2.6 Analog interfaces	15
2.6.1 Analog to Digital Converter (ADC).....	16
2.6.2 Comparator	16

2.6.3	Low power comparator	16
2.6.4	Analog pin options	17
2.7	GPIO	17
2.7.1	Drive strength.....	18
2.8	Debug interfaces	18
2.8.1	SWD.....	18
2.8.2	Trace – Serial Wire Output.....	18
2.9	u-connectXpress software features	18
2.9.1	u-blox Serial Port Service (SPS)	18
2.9.2	Module power-on	18
2.9.3	Module power off	19
2.9.4	Power modes	19
2.9.5	Module reset	20
2.9.6	System status signals.....	20
2.9.7	System control signals	20
2.9.8	UART signals	20
3	Pin definition.....	21
3.1	Pin assignment.....	21
3.2	Pin assignment in the u-connectXpress software.....	23
4	Electrical specifications.....	25
4.1	Absolute maximum ratings	25
4.1.1	Maximum ESD ratings.....	25
4.2	Operating conditions	25
4.2.1	Operating temperature range.....	25
4.2.2	Supply/Power pins	26
4.2.3	Current consumption.....	26
4.2.4	RF performance	26
4.2.5	NINA-B112 radiation patterns.....	27
4.2.6	RESET_N pin.....	29
4.2.7	Digital pins.....	29
4.2.8	I2C pull-up resistor values.....	29
4.2.9	Analog comparator.....	29
5	Mechanical specifications.....	30
5.1	NINA-B111 mechanical specification	30
5.2	NINA-B112 mechanical specifications.....	31
6	Qualification and approvals	32
6.1	European Union regulatory compliance	32
6.1.1	Compliance with the RoHS directive	32
6.1.2	Safety compliance	32
6.2	FCC and IC Compliance.....	32
6.2.1	IC compliance.....	32
6.2.2	Conformité aux norms d´IC.....	32

6.2.3	FCC statement.....	33
6.2.4	Labeling requirements for end product	33
6.2.5	FCC and IC IDs	34
6.3	Japan radio equipment compliance.....	34
6.4	NCC Taiwan compliance	34
6.4.1	Taiwan NCC Warning Statement.....	34
6.4.2	NINA-B111 labeling requirements for end product.....	35
6.4.3	NINA-B112 labeling requirements for end product.....	35
6.5	KCC South Korea compliance.....	35
6.6	Anatel Brazil compliance	35
6.7	Australia and New Zealand regulatory compliance	36
6.8	South Africa regulatory compliance	36
6.9	SRRC China Radio Transmission Equipment Type Approval	37
6.9.1	NINA-B112 labeling requirements for end product.....	37
6.10	Bluetooth qualification.....	37
7	Antennas	38
7.1	Antenna accessories	38
7.2	Approved antennas	39
8	Product handling	42
8.1	Packaging	42
8.1.1	Reels	42
8.1.2	Tapes.....	42
8.2	Moisture sensitivity levels.....	44
8.3	Reflow soldering	44
8.4	ESD precautions.....	44
9	Labeling and ordering information	45
9.1	Product labeling.....	45
9.2	Product identifiers	46
9.3	Identification codes	46
9.4	Ordering information.....	46
Appendix	47
A	Glossary	47
Related documents	48
Revision history	49
Contact		51

1 Functional description

1.1 Overview

NINA-B1 series modules are small stand-alone Bluetooth® low energy modules featuring Bluetooth 5, a powerful Arm® Cortex®-M4 with FPU, and state-of-the-art power performance. The embedded low power crystal in NINA-B1 minimizes power consumption, thus extending the battery life.

NINA-B1 is delivered with u-connectXpress software that provides support for u-blox Bluetooth low energy Serial Port Service, GATT client and server, beacons, NFC™, and simultaneous peripheral and central roles – all configurable from a host by using AT commands.

NINA-B1 offers full flexibility for customers who prefer to add their application to run on the built-in Cortex-M4 with FPU. With 512 kB flash and 64 kB RAM, it offers the best-in-class capacity for customer applications running on top of the Bluetooth low energy stack using SDK from Nordic Semiconductor or Arm® Mbed™. Additionally, NFC and interfaces such as SPI, I2C, and I2S are available, and features like Bluetooth Mesh, AirFuel, and Apple HomeKit are also supported.

NINA-B112 comes with an internal antenna and NINA-B111 has a pin for use with an external antenna. The internal PIFA antenna is specifically designed for the small NINA-B1 form factor and provides an extensive range of more than 300 m, independent of ground plane and component placement.

The module is globally certified for use with the internal antenna or a range of external antennas. This reduces time and effort for customers integrating NINA-B1 in their designs.

1.2 Product features

	NINA-B11		NINA-B12	
Grade				
Automotive				
Professional	•		•	
Standard				
Radio				
Chip inside	nRF52832			
Bluetooth qualification	v5.0		v5.0	
Bluetooth low energy	•		•	
Bluetooth output power EIRP [dBm]	7		6	
Max range [meters]	350		300	
NFC	•		•	
Antenna type (see footnotes)	pin		metal	
Application software				
u-connectXpress	•		•	
Open CPU for embedded customer applications		•		•
Interfaces				
UART	1	◆	1	◆
SPI		◆		◆
I2C		◆		◆
I2S		◆		◆
PDM and PWM		◆		◆
GPIO pins	7	19	7	19
AD converters [number of bits]		12		12
Features				
AT command interface	•		•	
MCU (see footnotes)		M4F		M4F
RAM [kB]		64		64
Flash [kB]		512		512
Simultaneous GATT server and client	•	◆	•	◆
Low Energy Serial Port Service	•		•	
Throughput [Mbit/s]	0.8	1.4	0.8	1.4
Maximum Bluetooth connections	7	20	7	20
Bluetooth mesh		◆		◆
FOTA		◆		◆

pin = Antenna pin
 metal = Internal metal PIFA antenna

◆ = Feature enabled by HW. The actual support depends on the open CPU application SW.
 M4F = 64 MHz Arm® Cortex-M4 with FPU

Table 1: NINA-B1 series main features summary

1.3 Block diagram

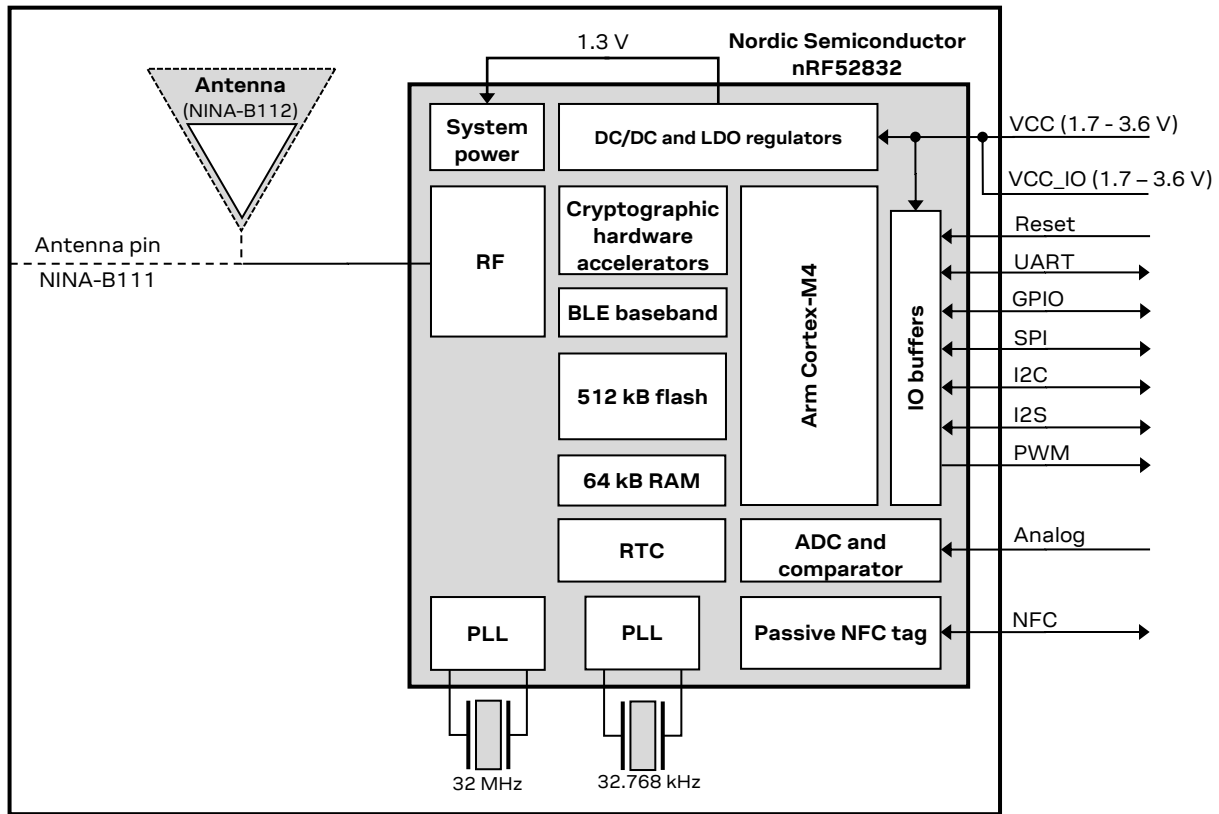

Figure 1: Block diagram of NINA-B1

1.3.1 NINA-B111

As NINA-B111 modules do not use the internal antenna, the PCB has been trimmed to allow for a smaller module (10.0 x 10.6 mm). Instead of an internal antenna, the RF signal is available at a module pin for routing to an external antenna or antenna connector.

1.3.2 NINA-B112

NINA-B112 modules use an integrated antenna mounted on the PCB (10.0 x 14.0 mm). The RF signal pin is not connected to any signal path.

1.4 Product description

Item	NINA-B111	NINA-B112
Bluetooth version	5.0	5.0
Band support	2.4 GHz, 40 channels	2.4 GHz, 40 channels
Typical conducted output power	+4 dBm	+4 dBm
Radiated output power (EIRP)	+7 dBm (with approved antennas)	+6 dBm
Sensitivity (conducted)	-95 dBm	-95 dBm
Data rates	1 and 2 Mbps GFSK	1 and 2 Mbps GFSK
Module size	10.0 x 10.6 mm	10.0 x 14.0 mm

Table 2: NINA-B1 series characteristics summary

1.5 Hardware options

Except for the different PCB sizes and antenna solutions, NINA-B1 series modules use an identical hardware configuration. An on board 32.768 KHz crystal is always included together with an integrated DC/DC converter for higher efficiency under heavy load situations. See also [Module supply input \(VCC\)](#).

1.6 Software options

The integrated application processor in NINA-B1 is an Arm Cortex-M4 with FPU with 512 kB flash memory and 64 kB RAM. The software structure of any program running on the module can be broken down into the following components:

- Radio stack
- Bootloader (optional)
- Application

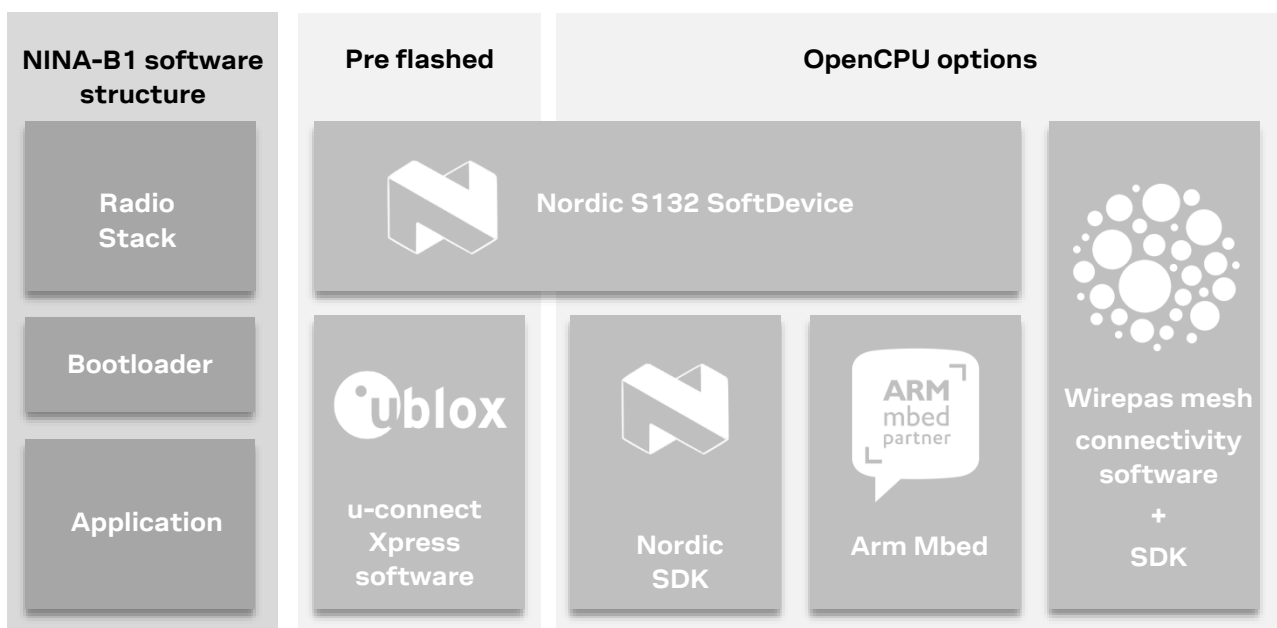

Figure 2: NINA-B1 software structure and available software options



For more information about the available software options, see also the NINA-B1 system integration manual [1].

1.6.1 u-connectXpress software

NINA-B1 is preflashed with u-connectXpress software.

The u-connectXpress software enables the use of the u-blox Low Energy Serial Port Service, which is controlled by AT commands over the UART interface. You can configure NINA-B1 modules with AT commands using the u-blox s-center evaluation software, which can be downloaded from the u-blox website and is available free of charge.

For more information about the u-blox Low Energy Serial Port Service, see also the u-connectXpress user guide [5] and u-connectXpress AT commands manual [3].

1.6.2 Open CPU

NINA-B1 can be used either together with the pre-flashed u-connectXpress software, or as an Open CPU module, with which you can run your own applications developed with either Arm® Mbed™, Nordic SDK, or embedded Wirepas Mesh development environment in NINA-B1.

1.6.2.1 Nordic SDK

The Nordic nRF5 SDK provides a rich and well tested software development environment for nRF52-based devices. It includes a broad selection of drivers, libraries, and example applications. It also includes other radio stacks, although NINA-B1 series modules are only certified for use with the S132 Bluetooth Low Energy SoftDevice. Customers that want to use a proprietary 2.4 GHz radio protocol should [contact](#) u-blox support.

1.6.2.2 Arm Mbed OS

Arm Mbed OS is an open-source embedded operating system designed specifically for the "things" in the "Internet of Things". It includes all features to develop a connected product, including security, connectivity, an RTOS, and drivers for sensors and I/O devices. The NINA-B1 series fully supports Mbed OS 5.

1.6.2.3 Wirepas connectivity software

NINA-B1 can also be used together with the Wirepas software stack. The stack enables the use of NINA-B1 modules in large-scale mesh environments.

Wirepas is third-party connectivity software licensed from Wirepas.

For more information about the Wirepas connectivity software, [contact](#) your local u-blox support team or Wirepas directly.

1.7 Bluetooth device address

Each NINA-B1 module is preprogrammed with a unique 48-bit Bluetooth device address. If the memory of the module is corrupted or lost, the address can be recovered from the data matrix barcode printed on the module label. For more information about Bluetooth device address recovery, see also the NINA-B1 system integration manual [1]

2 Interfaces

2.1 Power management

2.1.1 Module supply input (VCC)

NINA-B1 series uses integrated step-down converters to transform the supply voltage presented at the **VCC** pin into a stable system voltage. This means that NINA-B1 modules are compatible for use in battery powered designs – without the use of an additional voltage converter.

The modules support two on-board converters:

- A low-dropout (LDO) converter
- A DC/DC buck converter

The module automatically switches between these converters to suit the prevailing current consumption. The DC/DC converter is more efficient under high loads when the radio is active, while the LDO converter is better suited for power saving modes.

2.1.2 Digital I/O interfaces reference voltage (VCC_IO)

All modules in the NINA series generally provide an additional voltage supply input for setting the I/O voltage level. In NINA-B1 series modules, the I/O voltage level is similar to the supply voltage and **VCC_IO** is internally connected to the supply input. Therefore, only a single supply voltage is needed for NINA-B1, which makes it ideal for battery powered designs.

 The supply arrangements can vary in other modules in the NINA series. A design that is pin compatible with other NINA-series modules should keep the **VCC** and **VCC_IO** supply rails separate.

2.2 RF antenna interfaces

2.2.1 2.4 GHz Bluetooth low energy (ANT)

NINA-B111 and B112 have their own 2.4 GHz antenna solutions:

- NINA-B111 modules are equipped with an antenna pin (ANT) with a nominal characteristic impedance of 50 Ω . This pin can be connected to an on-board antenna, or antenna connector, using a controlled impedance trace. For more information, see also the NINA-B1 system integration manual [1].
- NINA-B112 modules use an integrated antenna solution; no additional components are required. The ANT pin is internally disconnected on these models.

2.2.2 Near Field Communication (NFC)

NINA-B1 series modules include a Near Field Communication interface that is capable of operating as a 13.56 MHz NFC tag at a bit rate of 106 kbps.

As an NFC tag, data can be read from or written to NINA-B1 using an NFC reader. However, NINA-B1 modules are not capable of reading other tags or initiating NFC communications.

The NFC interface can be used to wake the module from sleep mode, which means that the module can be kept in the deepest power save mode and still wake up properly to react to an NFC field.

Two pins are available for connecting to an external NFC antenna: **NFC1** and **NFC2**. See also the NINA-B1 system integration manual [1].

2.3 System functions

2.3.1 Power modes

NINA-B1 series modules use power-efficient LDO and DC/DC regulators and can operate in different power modes and configurations. Consequently, specific parts of the module can be powered off when they are not needed and complex wake-up events can be generated from different external and internal inputs.

2.3.1.1 System OFF mode

System OFF mode is the deepest power saving mode. It is in this mode that NINA-B1 modules sleep, so that all functionality is stopped to ensure minimum power consumption.

An external event is required to wake up the module from sleep in the system OFF mode. Although the module always reboots after waking up from the system OFF mode, some non-volatile registers in RAM can be configured so that they remain intact during and after going to the system OFF mode.

You can switch on or reboot NINA-B1 modules in any of the following ways:

- Module reset. See also [Module reset](#).
- Programmable digital or analog sensor event. In response to a rising voltage level flag from an analog comparator pin, or similar.
- NFC field detection
- 5 V supply to the **VBUS** pin (USB interface plug in)

2.3.1.2 System ON mode

When powered on or reset, NINA-B1 modules return to the default configuration set by the application software flashed in the module. In System ON mode all functional blocks and system peripherals are available in either RUN mode or in IDLE mode. The software configuration and the application under execution determines the mode of operation.

System ON mode has two optional sub-power modes, Constant Latency and Low-Power. Designers can choose which sub-power mode is most appropriate for the application, but only one can be enabled at any given time. These modes are active when the CPU or other peripherals are idling.

2.3.1.2.1 Constant latency

You can configure the CPU and other programmable peripherals to use minimal resources. The module can be turned on from sleep (System OFF mode) with constant and predictable CPU wakeup latency, but not without introducing some degradation in the power efficiency.

2.3.1.2.2 Low-Power

The module draws least power in the (default) Low-power mode of NINA-B1 modules. The automatic power management system in the Nordic chip limits the minimum power consumption. The module is turned on from sleep with varying CPU wakeup latency and peripherals tasks.

2.3.2 Module reset

A reset on NINA-B1 module can be triggered with following different ways:

- **Pin reset:** A low level on the **RESET_N** input pin. If used, the software should configure a pull-up on this pin. The low-level state causes an “external” or “hardware” reset of the module.
- **Power-on reset:** when VCC rises above the power-on threshold.
- **Wake from System OFF:** when module wakes from System OFF mode.
- **Soft reset,** using the reset control register.
- **Watchdog timer (WDT) reset:** when module watchdog timer times out.
- **Brownout reset:** when VCC drops below brownout threshold voltage

2.3.3 CPU and memory

The Nordic Semiconductor nRF52832 chip in the NINA-B1 series modules includes a powerful Arm® Cortex®-M4 with FPU processor has 32-bit instruction set. The processor works with a superset of 16 and 32-bit instructions (Thumb-2) at 64 MHz clock speed. It can use up to 37 interrupt vectors and 3 priority bits. The nRF52832 chip has 512 kB of flash and 64 KB of RAM for code and data storage.

2.3.4 Direct Memory Access

All interfaces described in this data sheet support Direct Memory Access (DMA) to move any data generated from the interface directly into the RAM, without involving the CPU. This ensures fluent operation of the CPU with minimal need for interruption. To reduce the overall power consumption, DMA should be used as often as possible.

2.3.5 Programmable Peripheral Interconnect

The Nordic Semiconductor nRF52832 chip in the NINA-B1 series modules includes a programmable peripheral interconnect (PPI) switch matrix that connects various control signals between different interfaces and system functions. The switch allows most interfaces to bypass the CPU when triggering a system function. In this way, an incoming data packet can trigger a counter on the falling voltage level on an ADC or toggle a GPIO – without having to send an interrupt to the CPU. This functionality facilitates the development of smart, power-efficient applications that wake up the CPU only when it is necessary.

2.3.6 Real Time Counter (RTC)

A key system feature of the module is the Real Time Counter (RTC). This counter can generate and send multiple interrupts and events to the internal and external hardware blocks, CPU and radio. The events can be precisely timed and range from microseconds up to hours and leveraged for periodic Bluetooth LE advertising and other applications – without involving the CPU. The RTC can be operated in the active and standby modes.

2.4 Serial interfaces

NINA-B1 modules provide the following serial communication interfaces:

- 1x UART interfaces: 4-wire universal asynchronous receiver/transmitter
- 3x SPI interfaces: Up to four serial peripheral interfaces can be used simultaneously
- 2x I2C interfaces: Inter-Integrated Circuit (I2C) interface for communication with digital sensors
- 1x I2S interface: Used to communicate with external audio devices

 Most digital interface pins on the module are shared between the digital, analog interfaces and GPIOs. Unless otherwise stated, all functions can be assigned to any pin that is not already occupied.

 Two of the SPI interfaces share common hardware with the I2C interfaces. These interfaces cannot be used simultaneously. If both I2C interfaces are in use only one SPI interface is available.

2.4.1 Asynchronous serial interface (UART)

The 4-wire UART interface supports hardware flow control and baud rates up to 1 Mbps. Other characteristics of the UART interface are listed below:

- Pin configuration:
 - **TXD**, data output pin
 - **RXD**, data input pin
 - **RTS**, Request To Send, flow control output pin (optional)
 - **CTS**, Clear To Send, flow control input pin (optional)
- Hardware flow control or no flow control is supported.
- Power saving indication available on the hardware flow control output (**RTS** pin): The line is driven to the OFF state when the module is not ready to accept data signals.
- Programmable baud rate generator allows most industry standard rates, as well as non-standard rates up to 1 Mbps.
- Frame format configuration:
 - 8 data bits
 - Even or no-parity bit
 - 1 stop bit
- Default frame configuration is 8N1, meaning eight (8) data bits, no (N) parity bit, and one (1) stop bit.
- Frames are transmitted in such a way that the least significant bit (LSB) is transmitted first.

2.4.2 Serial peripheral interface (SPI)

NINA-B1 supports up to three Serial Peripheral Interfaces with serial clock frequencies up to 8 MHz. Characteristics of the SPI interfaces are listed below:

- Pin configuration in master mode:
 - **SCLK**, Serial clock output
 - **MOSI**, Master Output Slave Input data line
 - **MISO**, Master Input Slave Output data line
- Pin configuration in slave mode:
 - **SCLK**, Serial clock input
 - **MOSI**, Master Output Slave Input data line
 - **MISO**, Master Input Slave Output data line
- Both master and slave modes are supported on all the interfaces.
- The serial clock supports both normal and inverted clock polarity (CPOL) and data should be captured on rising or falling clock edge (CPHA).

2.4.3 Inter-Integrated Circuit interface (I2C)

The Inter-Integrated Circuit (I2C) interfaces can be used to transfer and/or receive data on a 2-wire bus network. The NINA-B1 modules can operate as both master and slave on the I2C bus using standard (100 kbps), fast (400 kbps), and 250 kbps transmission speeds. The interface supports clock stretching, which allows NINA-B1 to temporarily pause any I2C communications. Up to 127 individually addressable I2C devices can be connected to the same two signals.

- Pin configuration:
 - **SCL**, clock output in master mode, input in slave mode
 - **SDA**, data input/output pin

This interface requires external pull-up resistors to work properly in the master mode. See also [I2C pull-up resistor values](#). The pull-up resistors are also required in slave mode and these should be placed at the master end of the interface.

2.4.4 Inter-IC Sound interface (I2S)

The Inter-IC Sound (I2S) interface can be used to transfer audio sample streams between NINA-B1 and external audio devices such as codecs, DACs, and ADCs. It supports original I2S and left or right-aligned interface formats in both master and slave modes.

- Pin configuration:
 - **MCK**, master clock
 - **LRCK**, left right/word/sample clock
 - **SCK**, serial clock
 - **SDIN**, serial data in
 - **SDOUT**, serial data out

The master side of an I2S interface always provides the **LRCK** and **SCK** clock signals, but some master devices cannot generate a **MCK** clock signal. NINA-B1 can supply a **MCK** clock signal in both master and slave modes to provide to those external systems that cannot generate their own clock signal. The two data signals - **SDIN** and **SDOUT** allow for simultaneous bi-directional audio streaming. The interface supports 8, 16, and 24-bit sample widths with up to 48 kHz sample rate.

2.5 Digital interfaces

2.5.1 Pulse Width Modulation (PWM)

NINA-B1 modules provide up to 16 independent PWM channels that can be used to generate complex waveforms. The waveforms can be used to control motors, dim LEDs, or as audio signals if connected to the speakers. Duty-cycle sequences may be stored in the RAM to be chained and looped into complex sequences without CPU intervention. Each channel uses a single GPIO pin as output.

2.5.2 Pulse Density Modulation (PDM)

The pulse density modulation interface is used to read signals from external audio frontends like digital microphones. It supports single or dual-channel (left and right) data input over a single GPIO pin. It supports up to 16 kHz sample rate and 16-bit samples. The interface uses the DMA to automatically move the sample data into RAM without CPU intervention. The interface uses two signals - **CLK** to output the sample clock and **DIN** to read the sample data.

2.5.3 Quadrature Decoder (QDEC)

The quadrature decoder is used to read quadrature encoded data from mechanical and optical sensors in the form of digital waveforms. Quadrature encoded data is often used to indicate rotation of a mechanical shaft in either a positive or negative direction. The QDEC uses two inputs - **PHASE_A** and **PHASE_B**, and an optional **LED** output signal. The interface has a selectable sample period ranging from 128 μ s to 131 ms.

2.6 Analog interfaces

8 out of the 19 digital GPIOs can be multiplexed to analog functions. The following analog functions are available:

- 1x 8-channel ADC
- 1x Analog comparator*
- 1x Low-power analog comparator*

*Only one comparator can be used at any given point in time.

2.6.1 Analog to Digital Converter (ADC)

The Analog to Digital Converter (ADC) is used to sample analog voltage on the analog function enabled pins of the NINA-B1. Any of the 8 analog inputs can be used. Characteristics of the ADC include:

- Full swing input range of 0 V to **VCC**.
- 8/10/12-bit resolution
- 14-bit resolution while using oversampling
- Up to 200 kHz sample rate
- Single shot or continuous sampling
- Two operation modes: Single-ended or Differential
- Single-ended mode:
 - A single input pin is used
- Differential mode:
 - Two inputs are used and the voltage level difference between them is sampled

If the sampled signal level is much lower than the **VCC**, it is possible to lower the input range of the ADC to better encompass the wanted signal and achieve higher resolution. Continuous sampling can be configured to sample at a configurable time interval, or at different internal or external events, without CPU involvement.

2.6.2 Comparator

The analog comparator compares the analog voltage on one of the analog enabled pins in NINA-B1 with a highly configurable internal or external reference voltage. Events can be generated and distributed to the rest of the system when the voltage levels cross. Further characteristics of the comparator include:

- Full swing input range of 0 V to VCC
- Two operation modes: Single-ended or Differential
- Single-ended mode: A single reference level or an upper and lower hysteresis selectable from a 64-level reference ladder with a range from 0 V to VREF (described in Table 3)
- Differential mode: Two analog pin voltage levels are compared, optionally with a 50 mV hysteresis
- Three selectable performance modes - High speed, balanced, or power save

For a comparison of the various analog comparator options, see also [Analog comparator](#).

2.6.3 Low power comparator

In addition to the power save mode available for the comparator, there is a separate low power comparator available on the NINA-B1 module. This allows for even lower power operation, at a slightly lower performance and with less configuration options. Characteristics of the low power comparator include:

- Full swing input range of 0 to **VCC**
- Two operation modes - Single-ended or Differential
- Single-ended mode:
 - The reference voltage **LP_VIN** is selected from a 15-level reference ladder
- Differential mode:
 - **GPIO_24** or **GPIO_25** is used as reference voltage
 - **LP_VIN** can be used to wake the system from sleep (system OFF mode)

Table 3 shows the analog pin options. To compare the electrical specifications for the different analog comparator options, see also [Analog comparator](#).

Since the run current of the low power comparator is very low, it can be used as an analog trigger to wake up the CPU when the module sleeps in the System OFF mode. See also [Power modes](#).

2.6.4 Analog pin options

Table 3 shows the supported connections of the analog functions.



An analog pin may not be simultaneously connected to multiple functions.

Symbol	Analog function	Can be connected to
ADCP	ADC single-ended or differential positive input	Any analog pin or VCC
ADCN	ADC differential negative input	Any analog pin or VCC
VIN+	Comparator input	Any analog pin
VREF	Comparator single-ended mode reference ladder input	Any analog pin, VCC, 1.2 V, 1.8V or 2.4V
VIN-	Comparator differential mode negative input	Any analog pin
LP_VIN+	Low-power comparator IN+	Any analog pin
LP_VIN-	Low-power comparator IN-	GPIO_24 or GPIO_25, 1/16 to 15/16 VCC in steps of 1/16 VCC

Table 3: Possible uses of the analog pins

2.7 GPIO

NINA-B1 series modules have a versatile pinout. With no dedicated analog or digital interfaces, all module interfaces and functions must be allocated to a specific GPIO pin. This is configured in the software.

NINA-B1 modules have 19 GPIO pins. 8 of these are analog-enabled pins that can be assigned to an analog function.

In addition to the serial interfaces, Table 4 describes the analog digital and functions that can be assigned to a GPIO pin. Two of the GPIOs are optional NFC.

Function	Description	Default NINA pin	Configurable GPIOs
General purpose input	Digital input with configurable edge detection and interrupt generation		Any
General purpose output	Digital output with configurable drive strength, pull-up, pull-down, open-source, open-drain and/or slew rate		Any
Pin disabled	Pin is disconnected from input buffers and output drivers.	All*	Any
Timer/ counter	High precision time measurement between two pulses/ Pulse counting with interrupt/event generation		Any
Interrupt/ Event trigger	Interrupt/event trigger to the software application/ Wake up event		Any
ADC input	8/10/12-bit analog to digital converter		Any analog
Analog comparator input	Compare two voltages, capable of generating wake-up events and interrupts		Any analog
PWM output	Output complex pulse width modulation waveforms		Any
Connection status indication	Indicates if a Bluetooth LE connection is maintained	BLUE**	Any

* = If left unconfigured

** = If using the u-connectXpress software

Table 4: GPIO custom functions configuration

2.7.1 Drive strength

All GPIO pins are normally configured for low current consumption. Using this standard low-drive strength, any pin configured as an output can only source or sink a certain amount of current. If the timing requirements of any digital interface cannot be met, or if an LED requires more current than the available amount of current in this mode, a high drive strength mode can be configured in the software so the digital output can draw more current. See also [Digital pins](#).

 Some GPIOs can introduce noise in the system when they are configured for high drive strength or connected to a signal with a switching speed higher than 10 kHz. See also [Pin assignment](#).

2.8 Debug interfaces

2.8.1 SWD

NINA-B1 series modules provide an SWD interface for flashing and debugging. The interface consists of two pins: **SWDCLK** and **SWDIO**.

2.8.2 Trace – Serial Wire Output

A serial trace option is available on the NINA-B1 series modules as an additional pin, **SWO**. The Serial Wire Output (SWO) is used to:

- Support printf style debugging
- Trace OS and application events
- Emit diagnostic system information

A debugger that supports Serial Wire Viewer (SWV) is required.

2.9 u-connectXpress software features

 This section describes the available features when using the u-connectXpress software. See the u-connectXpress AT commands manual [3] and u-connectXpress software user guide [5].

2.9.1 u-blox Serial Port Service (SPS)

The serial port service feature enables serial port emulation over Bluetooth low energy.

2.9.2 Module power-on

You can switch on or reboot the NINA-B1 modules in one of the following ways:

- Rising edge on the VCC pin to a valid supply voltage
- Issuing a reset of the module. See also [Module reset](#).

An event to wake up from the sleep mode to the active mode can be triggered by:

- Programmable digital or analog sensor event, e.g., rising voltage level on an analog comparator pin
- Detecting an NFC field

While waking up from the standby mode to active mode, an event can also be triggered by:

- The on-board Real Time Counter (RTC)
- The radio interface
- Detection of an NFC field

2.9.3 Module power off

There is no dedicated pin to power off the NINA-B1 modules. You can configure any GPIO pin to enter or exit [Sleep mode](#), which essentially powers down the module.

An under-voltage (brown-out) shutdown occurs on the NINA-B1 modules when the **VCC** supply drops below the operating range minimum limit. If this occurs, it is not possible to store the current parameter settings in the module's non-volatile memory.

2.9.4 Power modes

The NINA-B1 series modules are power efficient devices capable of operating in different power saving modes and configurations. Different sections of the module can be powered off when not needed and complex wake-up events can be generated from different external and internal inputs. The radio part of the module operates independently from the CPU. The three main power modes are:

- Active
- Standby
- Sleep

Depending on the application, the module should spend most of its time in either standby or sleep mode to minimize current consumption.

2.9.4.1 Standby mode

Standby mode is one of the power saving modes in NINA-B1 modules that essentially powers down the module but keeps the system RAM and configurations intact. It also allows for complex, autonomous power-up events including periodic RTC events and radio events.

The following events can be used to bring the module out of the standby mode:

- Internal wake-up events from the RTC, radio, NFC and so on.
- Analog or digital sensor events (programmable voltage level or edge detection)

During standby mode, the module is clocked at 32.768 kHz, which is generated by an internal RC-oscillator.

2.9.4.2 Sleep mode

Sleep mode is the deepest power saving mode of NINA-B1 modules. During sleep mode, all functionality is stopped to ensure minimum power consumption. The module needs an external event in order to wake up from the sleep mode. The module will always reboot after waking up from the sleep mode; however, different sections of the RAM can be configured to remain intact during and after going to the sleep mode.

The following events can be used to wake up the module out of the sleep mode:

- External event on a digital pin
- External analog event on a low power comparator pin
- Detection of an NFC field

When using the u-connectXpress software, the module can be manually switched on or off with proper storage of the current settings using the UART **DSR** pin.

The module can be programmed to latch the digital values present at its GPIO pins during sleep. The module will keep the values latched, and a change of state on any of these pins will trigger a wake-up to active mode.

2.9.5 Module reset

The NINA-B1 modules can be reset using one of the following ways:

- Low level on the **RESET_N** input pin, normally kept high using an internal pull-up. This causes an “external” or “hardware” reset of the module. The current parameter settings are not saved in the module’s non-volatile memory and a proper network detach is not performed.
- With the NINA-B1 modules, using the AT+CPWROFF command. This causes an “internal” or “software” reset of the module. The current parameter settings are saved in the module’s non-volatile memory.

2.9.6 System status signals

The RED, GREEN and BLUE pins are used to signal the system status according to Table 5. They are active low and are intended to be routed to an RGB LED.

Mode	Status	RGB LED color	RED	GREEN	BLUE
Data\Extended Data mode (EDM)	IDLE	Green	HIGH	LOW	HIGH
Command mode	IDLE	Orange	LOW	LOW	HIGH
EDM/Data mode, Command mode	CONNECTING	Purple	LOW	HIGH	LOW
EDM/Data mode, Command mode	CONNECTED*	Blue	HIGH	HIGH	LOW

* = LED flashes on data activity

Table 5: System status indication



CONNECTING and CONNECTED status indicate u-blox SPS connections.

2.9.7 System control signals

The following input signals are used to control the system:

- **RESET_N** is used to reset the system. See also [Module reset](#).
- If **SWITCH_2** is driven low during start up, the UART serial settings are restored to their default values.
- **SWITCH_2** can be used to open a Bluetooth LE connection with a peripheral device.
- If both **SWITCH_1** and **SWITCH_2** are driven low during start up, the system enters the bootloader mode.
- If both **SWITCH_1** and **SWITCH_2** are driven low during start up and held low for 10 seconds, the system exits the bootloader mode and restore all settings to their factory default.

2.9.8 UART signals

In addition to the normal **RXD**, **TXD**, **CTS**, and **RTS** signals, the u-connectXpress software adds the **DSR** and **DTR** pins to the UART interface. Note that they are not used as originally intended, but to control the state of the NINA module. For example, depending on the current configuration.

The **DSR** pin can be used to:

- Enter command mode
- Disconnect and/or toggle connectable status
- Enable/disable the rest of the UART interface

Enter/wake up from sleep mode

The **DTR** pin can be used to indicate:

- The system mode
- If the SPS peers are connected
- If a Bluetooth LE bonded device is connected
- A Bluetooth LE GAP connection

3 Pin definition

3.1 Pin assignment

Figure 3 shows an example of the module pinout in an unconfigured state, where:

- The grey pins shown in the center of module are GND pins.
- The outline of NINA-B111 ends at the dotted line, where the antenna area of NINA-B112 begins.
- Most of the digital or analog functions shown here and described in this data sheet can be freely assigned to any GPIO pin. Analog functions are limited to analog capable pins.
- Signals that are highlighted in red are not freely assignable but are locked to a specific pin.
- GPIO pins 16, 17, 18 and 20 are connected to the pins located close to the radio part of the RF chip. Digital noise on these pins can reduce the radio sensitivity.

If you use the u-connectXpress software, refer to the [Pin assignment in the u-connectXpress software](#).

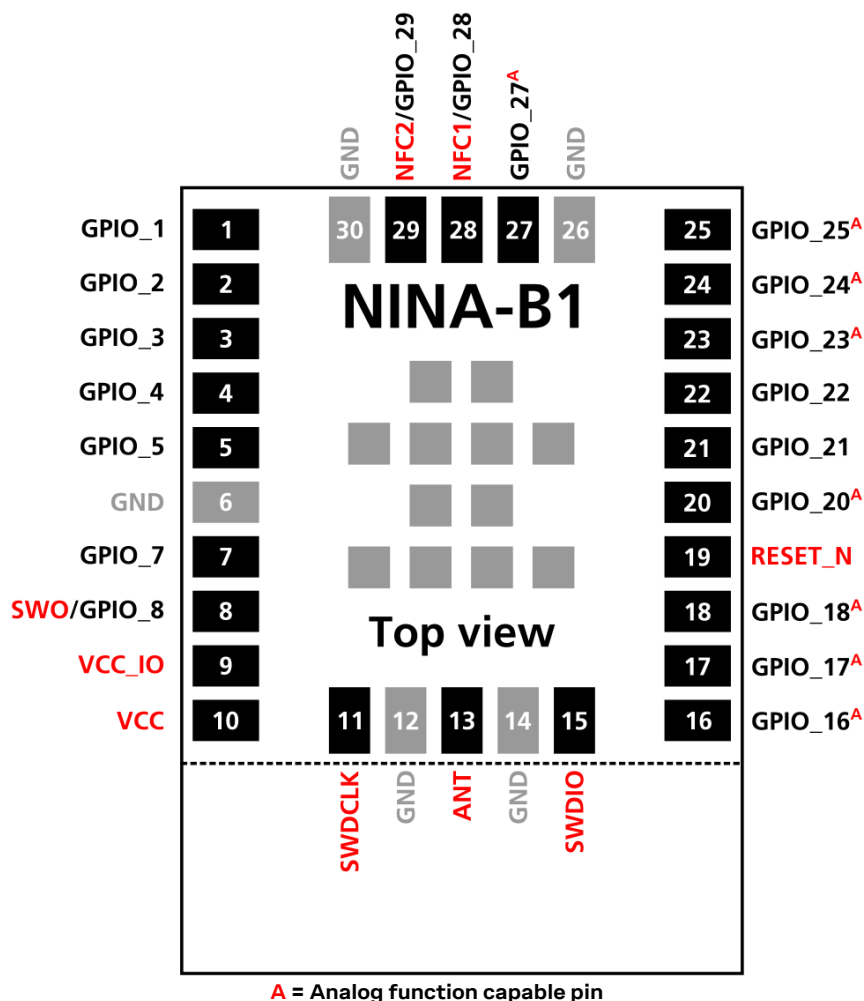

Figure 3: NINA-B1 series pin assignment (top view)

- ⚠** Do not apply an NFC field to the NFC pins when they are configured as GPIOs. Applying the field in these circumstances can cause permanent damage to the module. When driving different logic levels on these pins in GPIO mode a small current leakage is expected. Ensure that NFC pins are set to the same logic level before entering any of the power saving modes. See also [RESET_N pin](#).

No.	Name	I/O	Description	nRF52 pin	Remarks
1	GPIO_1	I/O	General purpose I/O	P0.08	
2	GPIO_2	I/O	General purpose I/O	P0.11	
3	GPIO_3	I/O	General purpose I/O	P0.12	
4	GPIO_4	I/O	General purpose I/O	P0.13	
5	GPIO_5	I/O	General purpose I/O	P0.14	
6	GND	-	Ground		
7	GPIO_7	I/O	General purpose I/O	P0.16	
8	SWO/GPIO_8	I/O	Serial Wire debug trace data output	P0.18	May be used as a GPIO
9	VCC_IO	I	Module I/O level voltage input		Must be connected to VCC on NINA-B1
10	VCC	I	Module supply voltage input		1.7-3.6 V range
11	SWDCLK	I	Serial Wire Debug port clock signal		
12	GND	-	Ground		
13	ANT	I/O	Tx/Rx antenna interface		50 Ω nominal characteristic impedance, only used with NINA-B111 modules
14	GND	-	Ground		
15	SWDIO	I/O	Serial Wire Debug port data signal		
16	GPIO_16	I/O	Analog function enabled GPIO	P0.28	Pin is analog capable, use as low drive, low frequency GPIO only
17	GPIO_17	I/O	Analog function enabled GPIO	P0.29	Pin is analog capable, use as low drive, low frequency GPIO only
18	GPIO_18	I/O	Analog function enabled GPIO	P0.30	Pin is analog capable, use as low drive, low frequency GPIO only
19	RESET_N	I/O	System reset input	P0.21	Active low
20	GPIO_20	I/O	Analog function enabled GPIO	P0.31	Pin is analog capable, use as low drive, low frequency GPIO only
21	GPIO_21	I/O	General purpose I/O	P0.07	
22	GPIO_22	I/O	General purpose I/O	P0.06	
23	GPIO_23	I/O	Analog function enabled GPIO	P0.05	Pin is analog capable
24	GPIO_24	I/O	Analog function enabled GPIO	P0.02	Pin is analog capable
25	GPIO_25	I/O	Analog function enabled GPIO	P0.03	Pin is analog capable
26	GND	-	Ground		
27	GPIO_27	I/O	Analog function enabled GPIO	P0.04	Pin is analog capable
28	NFC1/GPIO_28	I/O	NFC pin 1 (default)	P0.09	May be used as a GPIO
29	NFC2/GPIO_29	I/O	NFC pin 2 (default)	P0.10	May be used as a GPIO
30	GND	-	Ground		
	EGP	-	Exposed Ground Pins		The exposed pins in the center of the module should be connected to GND

Table 6: NINA-B1 series pinout

3.2 Pin assignment in the u-connectXpress software

The pinout as shown in Figure 4 describes the pin configuration used in the u-connectXpress software.

- The grey pins shown in the center of module are GND pins.
- The outline of NINA-B111 ends at the dotted line, where the antenna area of NINA-B112 begins.

Figure 4 and Table 7 reflect the latest u-connectXpress software version only.

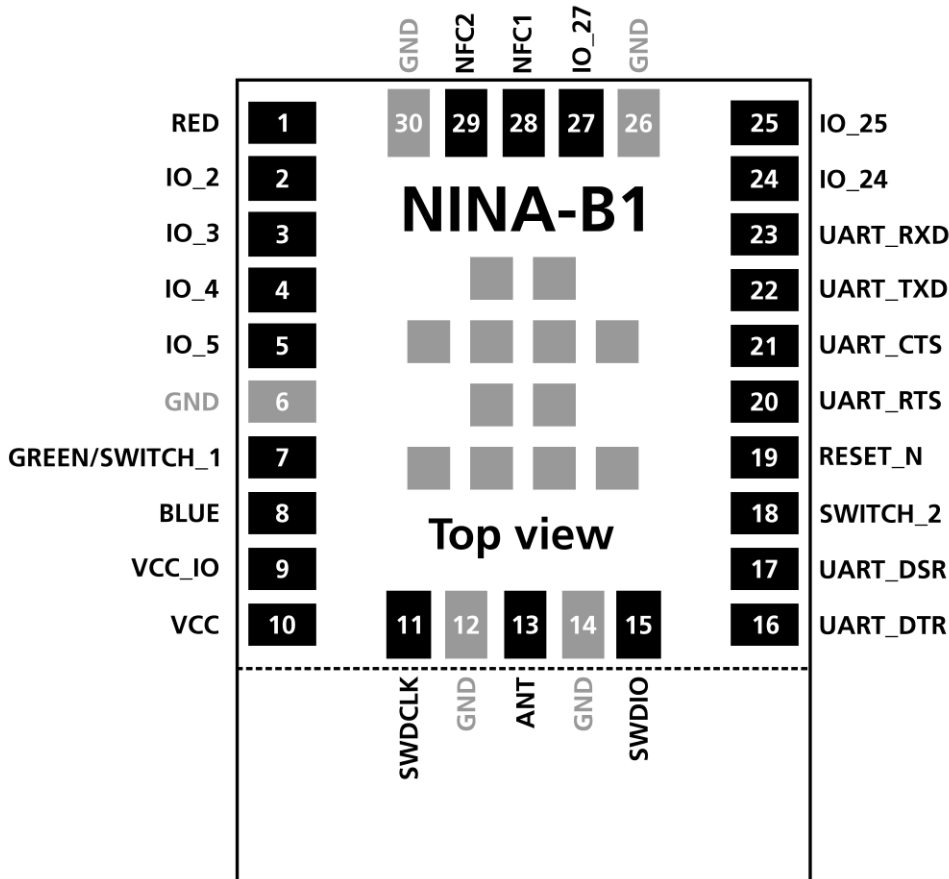



Figure 4: NINA-B1 series pin assignment (top view) while using the u-connectXpress software

It is required to follow this pin layout when using the u-connectXpress software. No additional interfaces can be added.

No.	Name	I/O	Description	Remarks
1	RED	O	RED system status signal	Active low, should be routed to an RGB LED
2	IO_2	I/O	u-connectXpress software IO pin	Can be used for manual digital I/O
3	IO_3	I/O	u-connectXpress software IO pin	Can be used for manual digital I/O
4	IO_4	I/O	u-connectXpress software IO pin	Can be used for manual digital I/O
5	IO_5	I/O	u-connectXpress software IO pin	Can be used for manual digital I/O
6	GND	-	Ground	
7	GREEN/SWITCH_1	I/O	This signal is multiplexed: GREEN: System status signal. SWITCH_1: Multiple functions	Active low. GREEN: Should be routed to an RGB LED. SWITCH_1: See also System control signals .
8	BLUE	O	BLUE system status signal	Active low, should be routed to an RGB LED
9	VCC_IO	I	Module I/O level voltage input	Must be connected to VCC on NINA-B1
10	VCC	I	Module supply voltage input	1.7–3.6 V
11	SWDCLK	I	Serial Wire Debug port clock signal	
12	GND	-	Ground	
13	ANT	I/O	Tx/Rx antenna interface	50 Ω nominal characteristic impedance, only used with NINA-B111 modules
14	GND	-	Ground	
15	SWDIO	I/O	Serial Wire Debug port data signal	
16	UART_DTR	O	UART data terminal ready signal	Used to indicate system status
17	UART_DSR	I	UART data set ready signal	Used to change system modes
18	SWITCH_2	I	Multiple functions	Active low, see also System control signals .
19	RESET_N	I	External system reset input	Active low
20	UART_RTS	O	UART request to send control signal	Used only when hardware flow control is enabled
21	UART_CTS	I	UART clear to send control signal	Used only when hardware flow control is enabled
22	UART_TXD	O	UART data output	
23	UART_RXD	I	UART data input	
24	IO_24	I/O	u-connectXpress software IO pin	Can be used for manual digital I/O
25	IO_25	I/O	u-connectXpress software IO pin	Can be used for manual digital I/O
26	GND	-	Ground	
27	IO_27	I/O	u-connectXpress software IO pin	Can be used for manual digital I/O
28	NFC1	I/O	NFC pin 1	
29	NFC2	I/O	NFC pin 2	
30	GND	-	Ground	
	EGP	-	Exposed Ground Pad	The exposed pads in the center of the module should be connected to GND

Table 7: NINA-B1 series and u-connectXpress software pinout

4 Electrical specifications

-  Stressing the device above one or more of the [Absolute maximum ratings](#) can cause permanent damage. These are stress ratings only. Operating the module at these or at any conditions other than those specified in the [Operating conditions](#) should be avoided. Exposure to the absolute maximum rating conditions for extended periods can affect device reliability.
-  Operating condition ranges define those limits within which the functionality of the device is guaranteed. Where application information is given, it can be considered as advisory only and does not form part of the specification.

4.1 Absolute maximum ratings

Symbol	Description	Condition	Min	Max	Unit
VCC	Module supply voltage	Input DC voltage at VCC pin	-0.3	3.9	V
V_DIO	Digital pin voltage	Input DC voltage at any digital I/O pin	-0.3	3.9	V
P_ANT	Maximum power at receiver	Input RF power at antenna pin		+10	dBm

Table 8: Absolute maximum ratings

-  NINA-B1 modules are not protected against overvoltage or reversed voltages. Voltage spikes exceeding the power supply voltage parameters shown in Table 8 must be kept within the specified limits using appropriate protection devices.



4.1.1 Maximum ESD ratings

Parameter	Min	Typical	Max	Unit	Remarks
ESD sensitivity for all pins except ANT pin			4	kV	Human body model according to JEDEC JS001
			750	V	Charged device model according to JESD22-C101
ESD indirect contact discharge			±8	kV	According to EN 301 489-1

Table 9: Maximum ESD ratings

-  NINA-B1 series modules are Electrostatic Sensitive Devices and require special precautions while handling. See also [ESD precautions](#).

4.2 Operating conditions

-  Unless otherwise specified, all operating condition specifications are taken at an ambient temperature of 25°C and a supply voltage of 3.0 V.
-  Operation beyond the specified operating conditions is not recommended and extended exposure beyond them may affect device reliability.
-  The RAM Data retention endurance is 10,000 write/erase cycles (10 years) throughout the temperature range up to 85 °C

4.2.1 Operating temperature range

Parameter	Min	Max	Unit
Storage temperature	-40	+85	°C
Operating temperature	-40	+85	°C

Table 10: Temperature range

4.2.2 Supply/Power pins

Symbol	Parameter	Min	Typ	Max	Unit
VCC	Input supply voltage	1.7	3.0	3.6	V
t_RVCC	Supply voltage rise time			60	ms
VCC_ripple	VCC input noise peak to peak, 10 - 100 KHz			100	mV
	VCC input noise peak to peak, 100 KHz - 1 MHz			50	mV
	VCC input noise peak to peak, 1 - 3 MHz			25	mV
VCC_IO	I/O reference voltage		VCC		V

Table 11: Input characteristics of voltage supply pins

4.2.3 Current consumption

Table 12 shows the typical current consumption for NINA-B1 – regardless of the software that is used.

Mode	Condition	Typical	Peak
Sleep	No clocks running, no RAM data retention	300 nA	
Sleep	No clocks running, 64 kB RAM data retention	620 nA	
Standby	RTC and 64 kB RAM data retention. System running on 32.768 kHz clock from crystal.	2.2 μ A	
Active	CPU running benchmarking tests @ 64 MHz clock speed, all interfaces idle	3.7 mA	
Active	Radio RX only	5.4 mA	
Active	Radio TX only, +0 dBm output power	5.3 mA	

Table 12: Module VCC current consumption

Make sure that the configured output power of your application product does not exceed the maximum allowed limits for your intended target market(s).

Table 13 shows the typical current consumption for NINA-B1 when using u-connectXpress software.

Mode	Condition	3.3 V VCC		1.8 V VCC	
		Average	Peak	Average	Peak
Active	Advertising 1s periods with +4 dBm output power and 31 bytes payload, CPU and UART interface is running	1.8 mA	12 mA	2.5 mA	20 mA
Standby	Advertising 1s periods with +4 dBm output power and 31 bytes payload	26 μ A	9.3 mA	34 μ A	16 mA
Standby	One advertisement event (4.7 ms), +4 dBm output power and 31 bytes payload	3.4 mA	9.3 mA	5.3 mA	16 mA
Active	Connected as peripheral, connection events 30 ms periods, +4 dBm output power and 0 bytes payload, CPU and UART interface is running	1.8 mA	12 mA	2.6 mA	21 mA
Standby	Connected as peripheral, connection events 30 ms periods, +4 dBm output power and 0 bytes payload	140 μ A	9.2 mA	190 μ A	16 mA
Sleep	UART DSR pin is used to enter sleep mode. No RAM retention	300 nA	2.6 mA	300 nA	2.6 mA

Table 13: Current consumption during typical use cases

4.2.4 RF performance

Parameter	Test condition	Min	Typ	Max	Unit
Receiver input sensitivity	Conducted at 25 °C		-95		dBm
Output power	Conducted at 25 °C		+4		dBm

Table 14: RF performance

4.2.5 NINA-B112 radiation patterns

Figure 5 shows the Azimuth and elevation rotation axes relative to the measurement of the antenna.

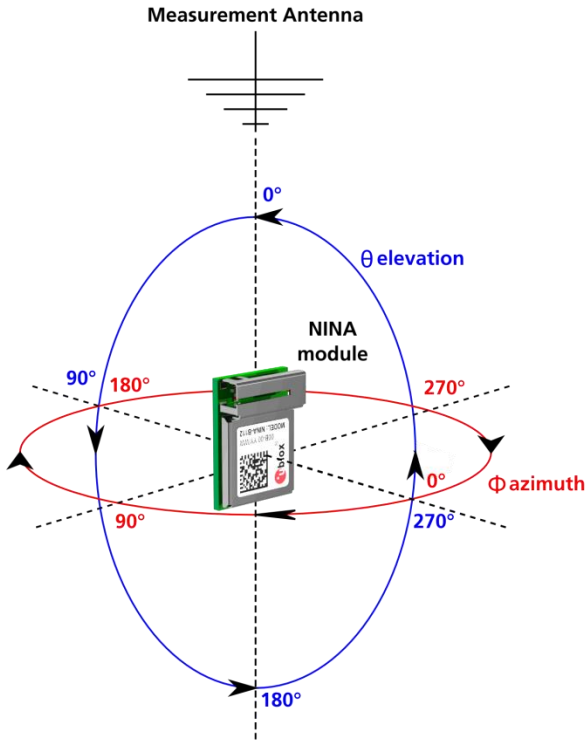

Figure 5: Azimuth and elevation rotation axes relative to the measurement antenna

Figure 6 – Figure 8 show the radiation patterns of an EVB-NINA-B112 transmitting at 0 dBm output power, with the module rotated 360° around the azimuth axis at different elevations, 0°, 90° and 180°. Both horizontal and vertical antenna polarizations were used during the testing.

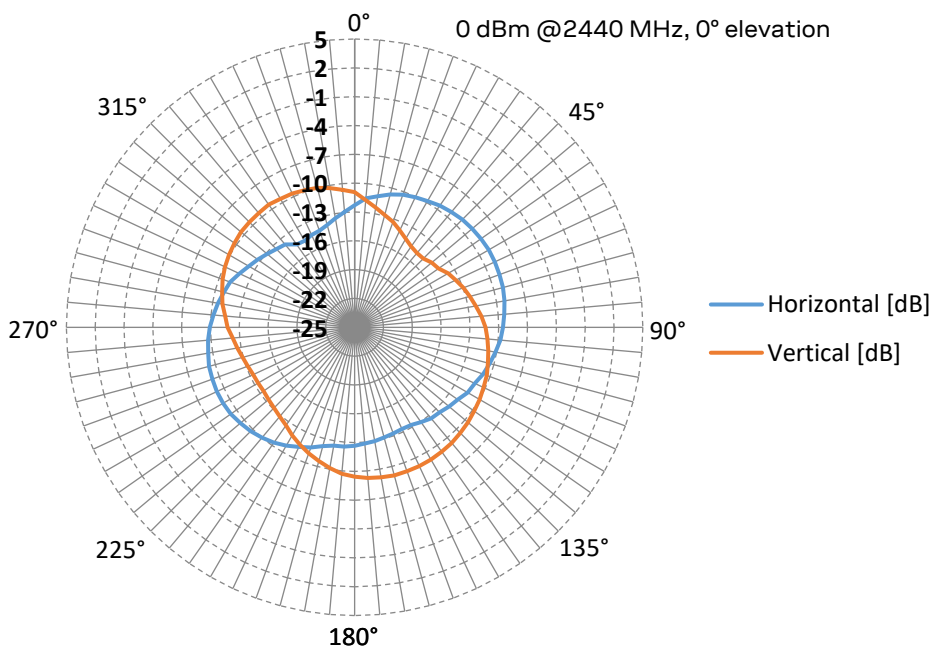

Figure 6: Radiation pattern of NINA-B112 kept at 0° elevation

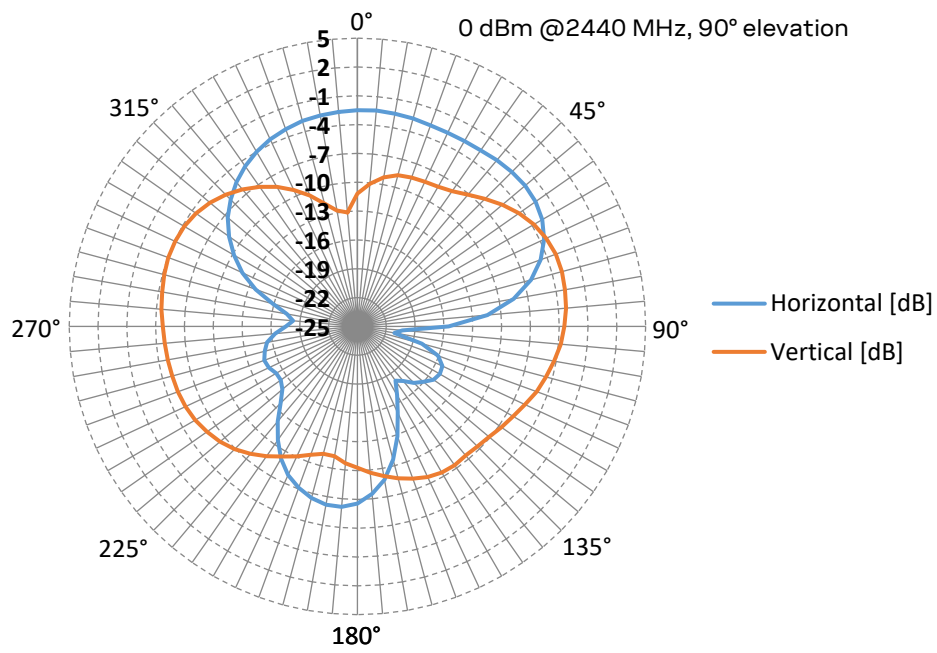

Figure 7: Radiation pattern of NINA-B112 kept at 90° elevation

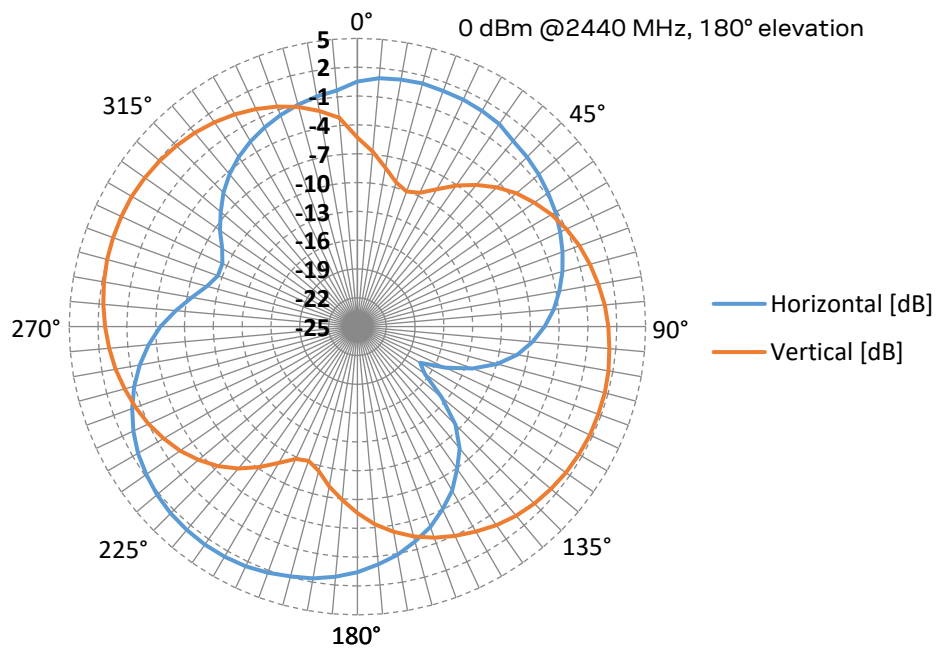

Figure 8: Radiation pattern of NINA-B112 kept at 180° elevation

4.2.6 RESET_N pin

Pin name	Parameter	Min	Typ	Max	Unit	Remarks
RESET_N	Low-level input	0		0.3*VCC	V	
	Internal pull-up resistance		13		kΩ	
	RESET duration			55	ms	Time taken to release a pin reset.

Table 15: RESET_N pin characteristics

4.2.7 Digital pins

Pin name	Parameter	Min	Typ	Max	Unit	Remarks
Any digital pin	Input characteristic: Low-level input	0		0.3*VCC	V	
	Input characteristic: high-level input	0.7*VCC		VCC	V	
	Output characteristic: Low-level output	0		0.4	V	Normal drive strength
		0		0.4	V	High drive strength
	Output characteristic: High-level output	VCC-0.4		VCC	V	Normal drive strength
		VCC-0.4		VCC	V	High drive strength
GPIO_28, GPIO_29	Leakage current		2	10	μA	When driven to different logic levels

Table 16: Digital pin characteristics

4.2.8 I2C pull-up resistor values

Symbol	Parameter	Bus capacitance	Min	Typ	Max	Unit
R_PUstandard	External pull-up resistance required on I2C interface in standard mode (100 kbps)	50 pF	1	-	23	kΩ
		200 pF	1	-	6	kΩ
		400 pF	1	-	5	kΩ
R_PUfast	External pull-up resistance required on I2C interface in fast mode (400 kbps)	50 pF	1	-	7	kΩ
		200 pF	1	-	1.75	kΩ
		400 pF	1	-	1	kΩ

Table 17: Suggested pull-up resistor values

4.2.9 Analog comparator

Symbol	Parameter	Min	Typ	Max	Unit
t_powersave	Time to generate interrupt/event when the comparator is in power save mode		0.6		μs
t_balanced	Time to generate interrupt/event when the comparator is in balanced mode		0.2		μs
t_speed	Time to generate interrupt/event when the comparator is in high speed mode		0.1		μs

Table 18: Electrical specification of the two analog comparators

5 Mechanical specifications

5.1 NINA-B111 mechanical specification

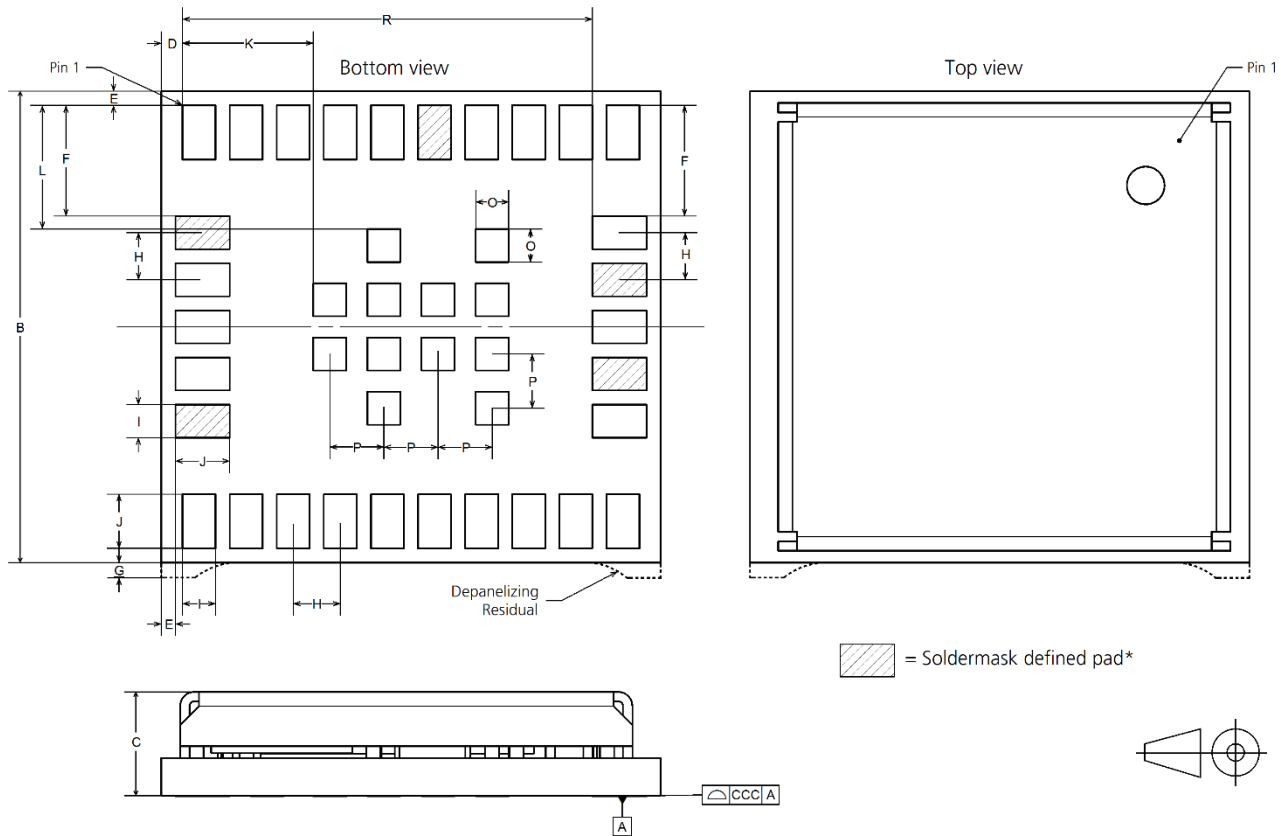

Figure 9: NINA-B111 mechanical outline

Parameter	Description	Typical		Tolerance	
A	Module PCB Length [mm]	10.6	(417 mil)	+0.20/-0.10	(+7.9/-3.9 mil)
B	Module PCB Width [mm]	10.0	(394 mil)	+0.20/-0.10	(+7.9/-3.9 mil)
C	Module Thickness [mm]	2.2	(87 mil)	+0.40/-0.20	(+16/-7.9 mil)
ccc	Seating Plane Coplanarity [mm]	0.10	(3.9 mil)	+0.02/-0.10	(+0.8/-3.9 mil)
D	Horizontal Edge to Lateral Pin No 1 Edge [mm]	0.45	(18 mil)	+0.10/-0.10	(+3.9/-3.9 mil)
E	Vertical and Horizontal Edge to Lateral Pin No 1 Edge	0.30	(12 mil)	+0.10/-0.10	(+3.9/-3.9 mil)
F	Vertical Pin No1 Edge to Lateral Pin Edge [mm]	2.35	(92.5 mil)	+0.05/-0.05	(+2/-2 mil)
G	Depanelizing Residual [mm]	0.10	(3.9 mil)	+0.25/-0.10	(+9.8/-3.9 mil)
H	Lateral and Antenna Row Pin to Pin Pitch [mm]	1.0	(39 mil)	+0.05/-0.05	(+2/-2 mil)
I	Lateral and Antenna Row Pin Width [mm]	0.70	(28 mil)	+0.05/-0.05	(+2/-2 mil)
J	Lateral and Antenna Row Pin Height [mm]	1.15	(45.3 mil)	+0.05/-0.05	(+2/-2 mil)
K	Horizontal Pin No1 Edge to Central Pin Edge [mm]	2.78	(109 mil)	+0.05/-0.05	(+2/-2 mil)
L	Vertical Pin No1 Edge to Central Pin Edge [mm]	2.63	(104 mil)	+0.05/-0.05	(+2/-2 mil)
O	Central Pin and Inner Row Width and Height [mm]	0.70	(28 mil)	+0.05/-0.05	(+2/-2 mil)
P	Central Pin to Central Pin Pitch [mm]	1.15	(45.3 mil)	+0.05/-0.05	(+2/-2 mil)
Q	Inner Row Pin to Pin Pitch [mm]	1.1	(43 mil)	+0.05/-0.05	(+2/-2 mil)
R	Horizontal Pin No1 Edge to Antenna Row Pin Edge	8.7	(343 mil)	+0.05/-0.05	(+2/-2 mil)
*	Soldermask defined pads additional height and/or	0.05	(2 mil)	-	-
	Module Weight [g]	<1.0			

Table 19: NINA-B111 mechanical outline data

5.2 NINA-B112 mechanical specifications

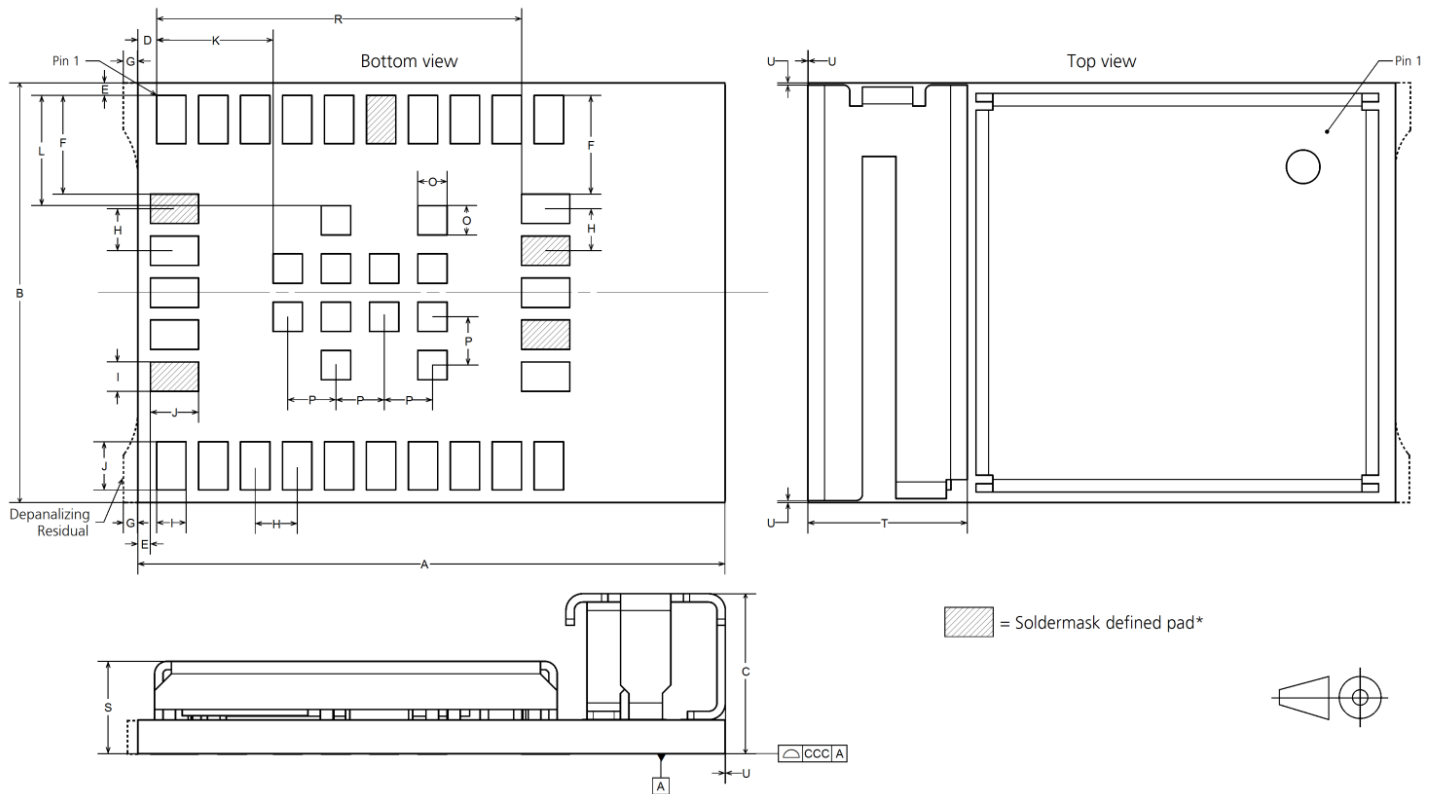

Figure 10: NINA-B112 mechanical outline

Parameter	Description	Typical		Tolerance	
A	Module PCB Length [mm]	14.0	(551 mil)	+0.20/-0.10	(+7.9/-3.9 mil)
B	Module PCB Width [mm]	10.0	(394 mil)	+0.20/-0.10	(+7.9/-3.9 mil)
C	Module Thickness [mm]	3.8	(150 mil)	+0.40/-0.20	(+16/-7.9 mil)
ccc	Seating Plane Coplanarity [mm]	0.10	(3.9 mil)	+0.02/-0.10	(+0.8/-3.9 mil)
D	Horizontal Edge to Lateral Pin No 1 Edge [mm]	0.45	(18 mil)	+0.10/-0.10	(+3.9/-3.9 mil)
E	Vertical and Horizontal Edge to Lateral Pin No 1 Edge	0.30	(12 mil)	+0.10/-0.10	(+3.9/-3.9 mil)
F	Vertical Pin No1 Edge to Lateral Pin Edge [mm]	2.35	(92.5 mil)	+0.05/-0.05	(+2/-2 mil)
G	Depanelizing Residual [mm]	0.10	(3.9 mil)	+0.25/-0.10	(+9.8/-3.9 mil)
H	Lateral and Antenna Row Pin to Pin Pitch [mm]	1.0	(39 mil)	+0.05/-0.05	(+2/-2 mil)
I	Lateral and Antenna Row Pin Width [mm]	0.70	(28 mil)	+0.05/-0.05	(+2/-2 mil)
J	Lateral and Antenna Row Pin Height [mm]	1.15	(45.3 mil)	+0.05/-0.05	(+2/-2 mil)
K	Horizontal Pin No1 Edge to Central Pin Edge [mm]	2.78	(109 mil)	+0.05/-0.05	(+2/-2 mil)
L	Vertical Pin No1 Edge to Central Pin Edge [mm]	2.63	(104 mil)	+0.05/-0.05	(+2/-2 mil)
O	Central Pin and Inner Row Width and Height [mm]	0.70	(28 mil)	+0.05/-0.05	(+2/-2 mil)
P	Central Pin to Central Pin Pitch [mm]	1.15	(45.3 mil)	+0.05/-0.05	(+2/-2 mil)
Q	Inner Row Pin to Pin Pitch [mm]	1.1	(43 mil)	+0.05/-0.05	(+2/-2 mil)
R	Horizontal Pin No1 Edge to Antenna Row Pin Edge	8.7	(343 mil)	+0.05/-0.05	(+2/-2 mil)
S	PCB and Shield Cover Thickness [mm]	2.2	(87 mil)	+0.40/-0.20	(+16/-7.9 mil)
T	Module Antenna Width [mm]	3.8	(150 mil)	+0.20/-0.20	(+7.9/-7.9 mil)
U	Antenna overhang outside module outline on any side	0.0	-	+0.60	(+24 mil)
*	Soldermask defined pads additional height and/or	0.05	(2 mil)	-	-
	Module Weight [g]	<1.0			

Table 20: NINA-B112 mechanical outline data

6 Qualification and approvals

6.1 European Union regulatory compliance

Information about European Union regulatory compliance for the NINA-B1 series modules is available in the NINA-B1 Declaration of Conformity [4].

6.1.1 Compliance with the RoHS directive

The NINA-B1 series modules comply with the "Directive 2015/863/EU" (RoHS 3) of the European Parliament and the Council on the Restriction of Use of certain Hazardous Substances in Electrical and Electronic Equipment (RoHS).

6.1.2 Safety compliance

In order to fulfill the safety standard EN 60950-1, the NINA-B1 series modules must be supplied with a Class-2 Limited Power Source.

6.2 FCC and IC Compliance

6.2.1 IC compliance

This device complies with Industry Canada license-exempt RSS standard(s).

Operation is subject to the following two conditions:

1. This device may not cause interference, and
2. This device must accept any interference, including interference that may cause undesired operation of the device.

Under Industry Canada regulations, this radio transmitter may only operate using an antenna of a type and maximum (or lesser) gain approved for the transmitter by Industry Canada. To reduce potential radio interference to other users, the antenna type and its gain should be chosen in such a way that the equivalent isotropically radiated power (e.i.r.p.) is not more than that is necessary for successful communication.

This equipment complies with IC RSS-102 radiation exposure limits set forth for an uncontrolled environment. This equipment should be installed and operated with a minimum distance of 20 cm between the radiator and your body.

6.2.2 Conformité aux normes d'IC

Cet appareil est conforme à la(aux) norme(s) RSS sans licence d'Industry Canada.

Son utilisation est soumise aux deux conditions suivantes:

1. Cet appareil ne doit pas causer d'interférences et
2. il doit accepter toutes interférences reçues, y compris celles susceptibles d'avoir des effets indésirables sur son fonctionnement.

Conformément aux réglementations d'Industry Canada, cet émetteur radio ne peut fonctionner qu'à l'aide d'une antenne dont le type et le gain maximal (ou minimal) ont été approuvés pour cet émetteur par Industry Canada. Pour réduire le risque d'interférences avec d'autres utilisateurs, il faut choisir le type d'antenne et son gain de telle sorte que la puissance isotrope rayonnée équivalente (p.i.r.e) ne soit pas supérieure à celle requise pour obtenir une communication satisfaisante.

Cet équipement respecte les limites d'exposition aux rayonnements IC RSS-102 définies pour un environnement non contrôlé. Il doit être installé et utilisé en maintenant une distance minimum de 20 cm entre le radiateur et votre corps.

6.2.3 FCC statement

This device complies with Part 15 of the FCC Rules. Operation is subject to the following two conditions:

1. This device may not cause harmful interference, and
2. This device must accept any interference received, including interference that may cause undesired operation.

 This equipment has been tested and found to comply with the limits for a Class B digital device, pursuant to Part 15 of the FCC Rules. These limits are designed to provide reasonable protection against harmful interference in a residential installation. This equipment generates, uses and can radiate radio frequency energy and, if not installed and used in accordance with the instructions, may cause harmful interference to radio communications. However, there is no guarantee that the interference will not occur in a particular installation. If this equipment does cause harmful interference to radio or television reception, which can be determined by turning the equipment off and on, the user is encouraged to try to correct the interference by one or more of the following measures:

- Reorient or relocate the receiving antenna
- Increase the separation between the equipment and receiver
- Connect the equipment into an outlet on a circuit different from that to which the receiver is connected.



Consult the dealer or an experienced radio/TV technician for help.

The NINA-B1 series modules are for OEM integrations only. The end-user product will be professionally installed in such a manner that only the authorized antennas are used.

For NINA-B111 an external antenna connector (U.FL. connector) reference design (see the NINA-B1 Series System Integration Manual [1]) is available and must be followed to comply with the NINA-B1 FCC/IC modular approval.

Any changes or modifications NOT explicitly APPROVED by u-blox could cause the module to cease to comply with FCC rules part 15, and thus void the user's authority to operate the equipment.

6.2.3.1 Cautions

-  Any changes or modification could cause the module to cease to comply with FCC rules part 15 and thus void the user's authority to operate the equipment.
-  §15.407 statement; in case of absence of information to transmit or operational failure, the NINA-B1 module will automatically discontinue transmission.

6.2.4 Labeling requirements for end product

For an end product using the NINA-B1 modules there must be a label containing, at least, the following information:

This device contains
 FCC ID: XPYNINAB1
 IC: 8595A-NINAB1

The label must be affixed on an exterior surface of the end product such that it will be visible upon inspection in compliance with the modular approval guidelines developed by the FCC.

In accordance with 47 CFR § 15.19, the end product shall bear the following statement in a conspicuous location on the device:

"This device complies with Part 15 of the FCC Rules. Operation is subject to the following two conditions:

- (1) This device may not cause harmful interference, and
- (2) This device must accept any interference received, including interference that may cause undesired operation."

When the device is so small or for such use that it is not practicable to place the statement above on it, the information shall be placed in a prominent location in the instruction manual or pamphlet supplied to the user or, alternatively, shall be placed on the container in which the device is marketed.

In case, where the final product will be installed in locations where the end-user is not able to see the FCC ID and/or this statement, the FCC ID and the statement shall also be included in the end-product manual.

6.2.5 FCC and IC IDs

Model	FCC ID	IC ID
NINA-B111	XPYNINAB1	8595A-NINAB1
NINA-B112	XPYNINAB1	8595A-NINAB1

Table 21: FCC and IC IDs for different models of the NINA-B1 series modules

6.3 Japan radio equipment compliance

The NINA-B1 series modules comply with the Japanese Technical Regulation Conformity Certification of Specified Radio Equipment (ordinance of MPT N°. 37, 1981), Article 2, Paragraph 1:

- Item 19 "2.4 GHz band wide band low power data communication system"

When a product integrated with a NINA-B1 module is placed on the Japanese market the product must be affixed with a label with the Giteki marking below. The marking must be visible for inspection.

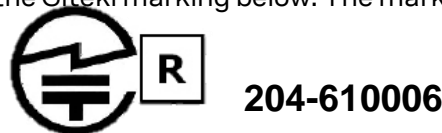

Figure 11: Giteki mark,  and the NINA-B1 MIC certification number

The recommended size of the Giteki mark is Ø5.0 mm but the minimum size is Ø3.0 mm.

As the MIC ID is not included on the NINA-B1 series label, the end product holder must also include a copy of the Japan Radio Certificate to the end product technical documentation. [Contact](#) your local u-blox support team to obtain a copy of the radio certificate.

6.4 NCC Taiwan compliance

6.4.1 Taiwan NCC Warning Statement

- 經型式認證合格之低功率射頻電機，非經許可，公司、商號或使用者均不得擅自變更頻率、加大功率或變更原設計之特性及功能。
- 低功率射頻電機之使用不得影響飛航安全及干擾合法通信；經發現有干擾現象時，應立即停用，並改善至無干擾時方得繼續使用。前項合法通信，指依電信法規定作業之無線電通信。低功率射頻電機須忍受合法通信或工業、科學及醫療用電波輻射性電機設備之干擾。

Statement translation:

- Without permission granted by the NCC, any company, enterprise, or user is not allowed to change frequency, enhance transmitting power or alter original characteristic as well as performance to approved low power radio-frequency devices.

- The low power radio-frequency devices shall not influence aircraft security and interfere legal communications; If found, the user shall cease operating immediately until no interference is achieved. The said legal communications means radio communications is operated in compliance with the Telecommunications Act. The low power radio-frequency devices must be susceptible with the interference from legal communications or ISM radio wave radiated devices.

6.4.2 NINA-B111 labeling requirements for end product

When a product containing a NINA-B111 module is placed on the Taiwanese market, the product must be affixed with a label or marking containing at least the following information:



Any similar wording that expresses the same meaning may be used. The marking must be visible for inspection.

6.4.3 NINA-B112 labeling requirements for end product

When a product containing a NINA-B112 module is placed on the Taiwanese market, the product must be affixed with a label or marking containing at least the following information:



Any similar wording that expresses the same meaning may be used. The marking must be visible for inspection.

6.5 KCC South Korea compliance

When a product containing a NINA-B1 module is placed on the South Korean market, the product must be affixed with a label or marking containing the KC logo and certification number shown in the figure below. This information must also be included in the products user manuals.



The height of the KC logo must be at least 5 mm.

6.6 Anatel Brazil compliance

When a product containing a NINA-B1 module is placed on the Brazilian market, the product must be affixed with a label or marking containing the Anatel logo, NINA-B1 Homologation number: 03882-16-05903 and a statement claiming that the device may not cause harmful interference but must accept it (Resolution No 506).



“Este equipamento opera em caráter secundário, isto é, não tem direito a proteção contra interferência prejudicial, mesmo de estações do mesmo tipo, e não pode causar interferência a sistemas operando em caráter primário.”

Statement translation:

“This equipment operates on a secondary basis and, consequently, must accept harmful interference, including from stations of the same kind, and may not cause harmful interference to systems operating on a primary basis.”

When the device is so small or for such use that it is not practicable to place the statement above on it, the information shall be placed in a prominent location in the instruction manual or pamphlet supplied to the user or, alternatively, shall be placed on the container in which the device is marketed.

In case, where the final product will be installed in locations where the end-user is not able to see the Anatel logo, NINA-B1 Homologation number and/or this statement, the Anatel logo, NINA-B1 Homologation number and the statement shall also be included in the end-product manual.

6.7 Australia and New Zealand regulatory compliance



The NINA-B1 modules are compliant with AS/NZS 4268:2012/AMDT 1:2013 standard – Radio equipment and systems – Short range devices – Limits and methods of standard measurement made by the Australian Communications and Media Authority (ACMA).

The NINA-B1 module test reports can be used as part of evidence in obtaining permission the Regulatory Compliance Mark (RCM). To meet overall Australian and/or New Zealand compliance on the end product, the integrator must create a compliance folder containing all the relevant compliance test reports.

More information on registration as a Responsible Integrator and labeling requirements will be found at the following websites:

Australian Communications and Media Authority web site <http://www.acma.gov.au/>.

New Zealand Radio Spectrum Management Group web site www.rsm.govt.nz.

6.8 South Africa regulatory compliance

The NINA-B1 modules are compliant and certified by the Independent Communications Authority of South Africa (ICASA). End products that are made available for sale or lease or is supplied in any other manner in South Africa shall have a legible label permanently affixed to its exterior surface. The label shall have the ICASA logo and the ICASA issued license number as shown in the figure below. The minimum width and height of the ICASA logo shall be 3 mm. The approval labels must be purchased by the customer’s local representative directly from the approval authority ICASA. A sample of a NINA-B1 ICASA label is included below:



More information on registration as a Responsible Integrator and labeling requirements will be found at the following website:

Independent Communications Authority of South Africa (ICASA) web site - <https://www.icasa.org.za>

6.9 SRRC China Radio Transmission Equipment Type Approval

 Only the NINA-B112 is modular approved for integration in an end product on the Chinese market.

In accordance with the provisions on the Radio Regulations of the People’s Republic of China, the NINA-B112 module with the product name NINA-B112 conforms to the provisions with its CMIIT ID: 2021DJ2218

6.9.1 NINA-B112 labeling requirements for end product

The following requirements apply for end products that are sold in China:

- Label with CMIIT ID number of the module is required to be placed on the end product.
- The following statement must be included in Chinese in the Chinese user manual:

本设备包含型号核准代码(分别为): CMIIT ID: 2021DJ2218的无线电发射模块。

6.10 Bluetooth qualification



NINA-B1 series modules are qualified as end products in accordance with the Bluetooth version 4.2 and 5.0 specifications. End products that integrate NINA-B1 require no other qualification.

If the end product is to be Bluetooth listed, the respective QD ID, shown in Table 22, must be included in the end product listing. Your choice of software, u-connectXpress from u-blox or Open CPU version from Nordic, determines the QD ID to include in the product listing.

Bluetooth version	Bluetooth product type	QD ID	Listing date	Nordic SoftDevice S132 version	u-connectXpress software version
4.2	End Product	85618	16-Aug-2016	3.0.0 to 4.0.x	1.0.0 to 3.0.1
5.0	End Product	100763	18-Sep-2017	5.0.0 or later	4.0.0 or later

Table 22: NINA-B1 Bluetooth QD IDs

7 Antennas

This chapter provides an overview of the different external antennas that can be used together with NINA-B1 series modules.

- ⚠ This radio transmitter IC: 8595A-NINAB1 has been approved by Industry Canada to operate with the antenna types listed below with the maximum permissible gain and required antenna impedance for each antenna type indicated. Antenna types not included in this list, having a gain greater than the maximum gain indicated for that type, are strictly prohibited for use with this device.
- ⚠ Cet émetteur radio IC: 8595A-NINAB1 été approuvé par Industry Canada pour fonctionner avec les types d’antenne énumérés ci-dessous avec le gain maximum autorisé et l’impédance nécessaire pour chaque type d’antenne indiqué. Les types d’antenne ne figurant pas dans cette liste et ayant un gain supérieur au gain maximum indiqué pour ce type-là sont strictement interdits d’utilisation avec cet appareil.

For each antenna, the “Approvals” field defines in which region or market the antenna is pre-approved for use with the NINA-B1 series modules. Definitions of the «Approvals» field are:

- FCC – The antenna is approved for use in countries that accept the FCC radio approvals, primarily the US.
- IC – The antenna is approved for use in countries that accept the IC radio approvals, primarily Canada.
- RED – The antenna is approved for use in countries that accept the Radio Equipment Directive, primarily the European countries.
- MIC – The antenna is approved for use in the Japanese market.
- NCC – The antenna is approved for use in the Taiwanese market.
- KCC – The antenna is approved for use in the Korean market.
- ANATEL – The antenna is approved for use in the Brazilian market.
- ACMA – The antenna is approved for use in the Australian and New Zealand markets.
- ICASA – The antenna is approved for use in the South African market.

In general, antennas with SMD connection, Reverse Polarity SMA connector or U.FL connector are approved for use in all the above mentioned markets. The antennas with SMA connector are not approved for use in the US or Canadian markets due to FCC/IC regulations.

7.1 Antenna accessories

Name	U.FL to SMA adapter cable
Connector	U.FL and SMA jack (outer thread and pin receptacle)
Impedance	50 Ω
Minimum cable loss	0.5 dB, The cable loss must be above the minimum cable loss to meet the regulatory requirements. Minimum cable length 100 mm.
Comment	The SMA connector can be mounted in a panel. See the NINA-B1 System Integration Manual [1] for information on how to integrate the U.FL connector.
Approval	RED, MIC, NCC, KCC, ANATEL, ACMA and ICASA



Name	U.FL to Reverse Polarity SMA adapter cable
Connector	U.FL and Reverse Polarity SMA jack (outer thread and pin)
Impedance	50 Ω
Minimum cable loss	0.5 dB, The cable loss must be above the minimum cable loss to meet the regulatory requirements. Minimum cable length 100 mm.
Comment	The Reverse Polarity SMA connector can be mounted in a panel. See the NINA-B1 System Integration Manual [1] for information on how to integrate the U.FL connector. It is required to follow this reference design to comply with the NINA-B1 FCC/IC modular approvals.
Approval	FCC, IC, RED, MIC, NCC, KCC, ANATEL, ACMA and ICASA



7.2 Approved antennas

NINA-B112 (u-blox LILY antenna)

Manufacturer	ProAnt
Gain	+3 dBi
Impedance	50 Ω
Size (HxWxL)	3.0 x 3.8 x 9.9 mm
Type	PIFA
Comment	SMD PIFA antenna on NINA-B112. Should not be mounted inside a metal enclosure.
Approval	FCC, IC, RED, MIC, NCC, KCC, ANATEL, ACMA and ICASA



GW.26.0111

Manufacturer	Taoglas
Polarization	Vertical
Gain	+2.0 dBi
Impedance	50 Ω
Size	\varnothing 7.9 x 30.0 mm
Type	Monopole
Connector	SMA (M)
Comment	To be mounted on the U.FL to SMA adapter cable.
Approval	RED, MIC, NCC, KCC, ANATEL, ACMA and ICASA



Ex-It 2400 28 RP-SMA

Manufacturer	ProAnt
Polarization	Vertical
Gain	+3.0 dBi
Impedance	50 Ω
Size	\varnothing 12.0 x 28.0 mm
Type	Monopole
Connector	Reverse Polarity SMA plug (inner thread and pin receptacle).
Comment	<p>This antenna must be mounted on a metal ground plane for best performance.</p> <p>To be mounted on the U.FL to Reverse Polarity SMA adapter cable.</p> <p>An SMA version antenna is also available but not recommended for use (Ex-IT 2400 SMA 28-001).</p>
Approval	FCC, IC, RED, MIC, NCC, KCC, ANATEL, ACMA and ICASA (certified unde PN Ex-IT 2400 RP-SMA 28-001)



Ex-It 2400 28 U.FL-100

Manufacturer	ProAnt
Polarization	Vertical
Gain	+2.0 dBi
Impedance	50 Ω
Size	\varnothing 12.0 x 28.0 mm
Type	Monopole
Cable length	100 mm
Connector	U.FL. connector
Comment	<p>This antenna must be mounted on a metal ground plane for best performance.</p> <p>To be mounted on a U.FL connector.</p> <p>See the NINA-B1 System Integration Manual [1] for information on how to integrate the U.FL connector. It is required to follow this reference design to comply with the NINA-B1 FCC/IC modular approvals.</p>
Approval	FCC, IC, RED, MIC, NCC, KCC, ANATEL, ACMA and ICASA (certified under the PN Ex-IT 2400 MHF 28)



Ex-It 2400 Foldable RP-SMA

Manufacturer	ProAnt
Polarization	Vertical
Gain	+3.0 dBi
Impedance	50 Ω
Size	\varnothing 10 x 83 mm
Type	Monopole
Connector	Reverse Polarity SMA plug (inner thread and pin receptacle)
Comment	<p>To be mounted on the U.FL to Reverse Polarity SMA adapter cable. An SMA version antenna is also available but not recommended for use (Ex-IT 2400 SMA 70-002).</p>
Approval	FCC, IC, RED, MIC, NCC, KCC, ANATEL, ACMA and ICASA (certified under the PN Ex-IT 2400 RP-SMA 70-002)



InSide-2400

Manufacturer	ProAnt
Gain	+3.0 dBi
Impedance	50 Ω
Size	27 x 12 mm (triangular)
Type	Patch
Cable length	100 mm
Connector	U.FL. connector
Comment	<p>Part of this antenna should be attached to a plastic enclosure for best performance.</p> <p>To be mounted on a U.FL connector.</p> <p>See the NINA-B1 System Integration Manual [1] for information on how to integrate the U.FL connector. It is required to follow this reference design to comply with the NINA-B1 FCC/IC modular approvals.</p>
Approval	FCC, IC, RED, MIC, NCC, KCC, ANATEL, ACMA and ICASA



FlatWhip-2400 RP-SMA

Manufacturer	ProAnt
Gain	+3.0 dBi
Impedance	50 Ω
Size	\varnothing 50.0 x 30.0 mm
Type	Monopole
Connector	Reverse Polarity SMA plug (inner thread and pin receptacle).
Comment	<p>To be mounted on the U.FL to SMA adapter cable. An SMA version antenna is also available but not recommended for use (FlatWhip-2400 SMA).</p> <p>EOL, not for new products.</p>
Approval	FCC, IC, RED, MIC, NCC, KCC, ANATEL, ACMA and ICASA



8 Product handling

8.1 Packaging

To enable efficient production, production lot set-up, and tear-down, NINA-B1 series modules are delivered as hermetically sealed, reeled tapes. For more information about packaging, see also the package information reference [2].

8.1.1 Reels

NINA-B1 modules are deliverable in quantities of 500 pieces on a reel. The reel types for the NINA-B1 modules are described in Table 23. For more information about the reel types, see also the Packaging information reference [2].

Model	Reel type
NINA-B111	B
NINA-B112	A

Table 23: Reel types for different models of the NINA-B1 series

8.1.2 Tapes

Figure 12 and Figure 13 shows the position and orientation of the NINA-B1 modules as they are delivered on tape. The dimensions of the tapes are specified in Figure 14 and Figure 15.



Figure 12: Orientation of NINA-B111 modules on tape



Figure 13: Orientation of NINA-B112 modules on tape

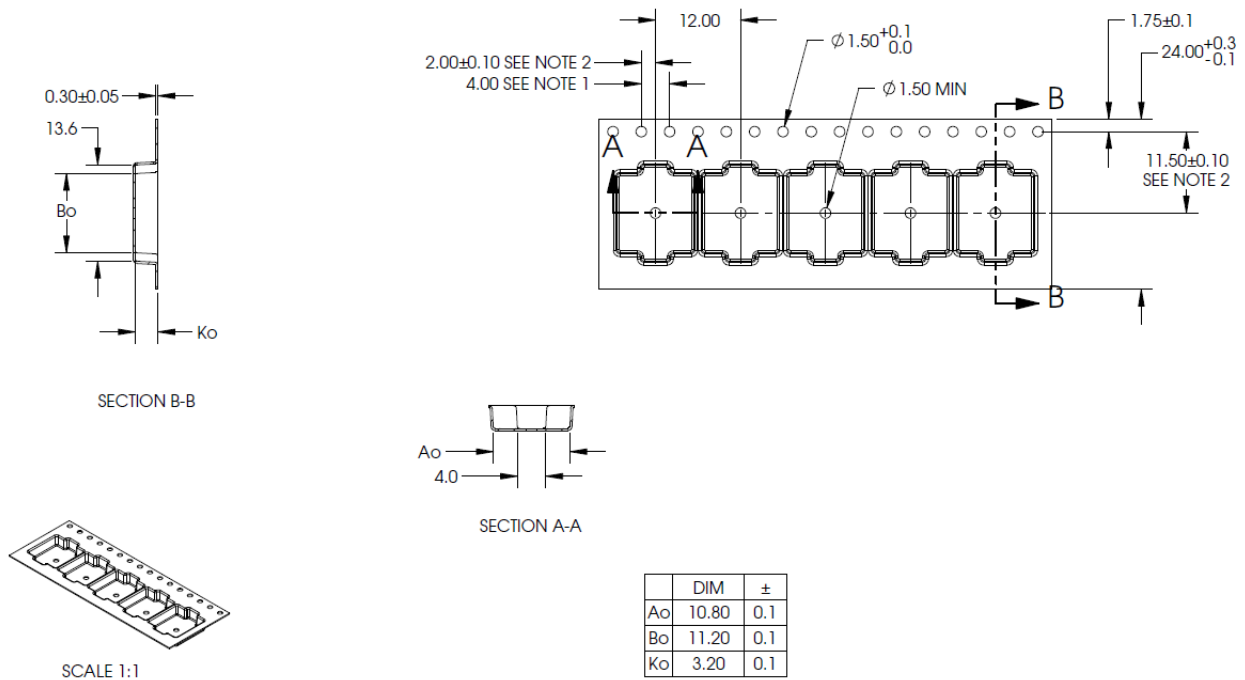

NOTES:

1. 10 SPROCKET HOLE PITCH CUMULATIVE TOLERANCE ± 0.2
2. POCKET POSITION RELATIVE TO SPROCKET HOLE MEASURED AS TRUE POSITION OF POCKET, NOT POCKET HOLE.
3. Ao AND Bo ARE MEASURED ON A PLANE AT A DISTANCE "R" ABOVE THE BOTTOM OF THE POCKET.

Figure 14: NINA-B111 tape dimensions

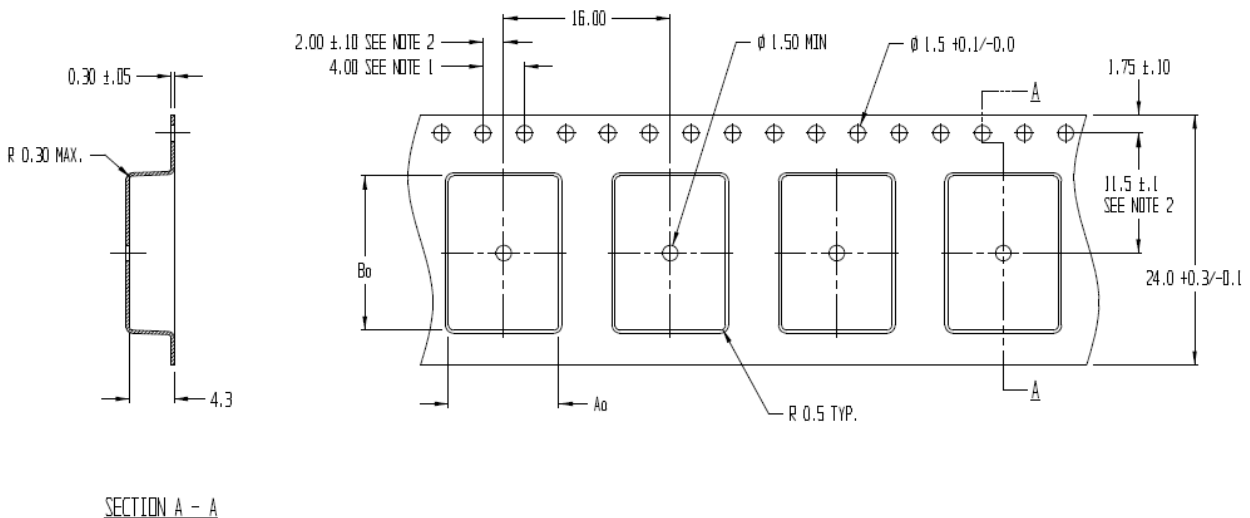

Ao = 10.6
Bo = 14.8
Ko = 4.3

NOTES:

1. 10 SPROCKET HOLE PITCH CUMULATIVE TOLERANCE ± 0.2
2. POCKET POSITION RELATIVE TO SPROCKET HOLE MEASURED AS TRUE POSITION OF POCKET, NOT POCKET HOLE
3. Ao AND Bo ARE CALCULATED ON A PLANE AT A DISTANCE "R" ABOVE THE BOTTOM OF THE POCKET.

Figure 15: NINA-B112 tape dimensions

8.2 Moisture sensitivity levels

-  In accordance with the IPC/JEDEC J-STD-020 standard, NINA-B1 series modules are tested, classified, and rated as Moisture Sensitive Devices (MSD). The Moisture Sensitivity Level (MSL) relates to the required packaging and handling precautions.

NINA-B1 series modules are rated at MSL level 4.

For more information about the moisture sensitivity levels, labeling, and storage of u-blox chips, modules, and antennas, see the Packaging information reference [2].

-  For general information about MSL, download the joint IPC/JEDEC J-STD-020 standard from www.jedec.org.

8.3 Reflow soldering

Reflow profiles are selected according to u-blox recommendations. For more information, see also the NINA-B1 system integration manual [1].

-  Failure to observe these recommendations can result in severe damage to the device.

8.4 ESD precautions

-  NINA-B1 series modules contain highly sensitive electronic circuitry and are Electrostatic Sensitive Devices (ESD). Handling NINA-B1 series modules without proper ESD protection may destroy or damage them permanently.

NINA-B1 series modules are electrostatic sensitive devices (ESD) and require special ESD precautions typically applied to the ESD sensitive components. See also. [Maximum ESD ratings](#) .



Proper ESD handling and packaging procedures must be applied throughout the processing, handling and operation of any application that incorporates the NINA-B1 series module. Failure to observe these recommendations can result in severe damage to the device.

Observance of ESD precautions is particularly important when handling the application board on to which the module is mounted. See also the NINA-B1 system integration manual [1].

9 Labeling and ordering information

9.1 Product labeling

The labels on NINA-B1 series modules include important product information.

Figure 16 shows the label applied to NINA-B1 series modules. Each of the given label references are described in Table 24.



Figure 16: Location of product type number on the NINA-B1 series module label

Reference	Description
1	Date of unit production (year/week)
2	Major and minor product version information
3	Product (model) name (NINA-B111 or NINA-B4112)
4	Data Matrix with unique serial number comprising 19 alphanumeric symbols: <ul style="list-style-type: none"> - The first 3 symbols are used for production tracking and are an abbreviated representation of the Type number that is unique to each module variant. - The following 12 symbols represent the unique hexadecimal Bluetooth address of the module AABCCDDEEFF, and <p>The last 4 symbols represent the hardware and firmware version encoded HFFF.</p>

Table 24: NINA-B1 series label description

9.2 Product identifiers

Table 25 describes the three product identifiers; specifically, the Type number, Model name and Ordering code.

Format	Description	Nomenclature
Model name	Describes the form factor, platform technology and platform variant. Used mostly in product documentation like this data sheet, the model name represents the most common identity for all u-blox products	PPPP-TGVV
Ordering code	Comprises the model name – with additional identifiers to describe the major product version and quality grade	PPPP-TGVV-TTQ
Type number	Comprises the model name and ordering code – with additional identifiers to describe minor product versions.	PPPP-TGVV-TTQ-XX

Table 25: Product code formats

9.3 Identification codes

Table 26 describes the individual identification codes represented in each product identifier.

Code	Meaning	Example
PPPP	Form factor	NINA
TG	Platform (Technology and Generation) T – Dominant technology, For example, W: Wi-Fi, B: Bluetooth, G - Generation	B1: Bluetooth Generation 1
VV	Variant based on the same platform; range [00...99]	11: default mounting, with antenna pin
TT	Major Product Version	00: first revision
Q	Quality grade A: Automotive B: Professional C: Standard	B: professional grade
XX	Minor product version (not relevant for certification)	Default value is 00

Table 26: Part identification code

9.4 Ordering information

Ordering Code	Product
NINA-B111-00B	NINA-B1 module with antenna pin, preflashed with u-connectXpress software v1.0.0
NINA-B111-01B	NINA-B1 module with antenna pin, preflashed with u-connectXpress software v2.0.0
NINA-B111-02B	NINA-B1 module with antenna pin, preflashed with u-connectXpress software v3.0.1
NINA-B111-03B	NINA-B1 module with antenna pin, preflashed with u-connectXpress software v4.0.0
NINA-B111-04B	NINA-B1 module with antenna pin, preflashed with u-connectXpress software v5.0.0
NINA-B111-05B	NINA-B1 module with antenna pin, preflashed with u-connectXpress software v7.0.0
NINA-B112-00B	NINA-B1 module with internal antenna, preflashed with u-connectXpress software v1.0.0
NINA-B112-01B	NINA-B1 module with internal antenna, preflashed with u-connectXpress software v2.0.0
NINA-B112-02B	NINA-B1 module with internal antenna, preflashed with u-connectXpress software v3.0.1
NINA-B112-03B	NINA-B1 module with internal antenna, preflashed with u-connectXpress software v4.0.0
NINA-B112-04B	NINA-B1 module with internal antenna, preflashed with u-connectXpress software v5.0.0
NINA-B112-05B	NINA-B1 module with internal antenna, preflashed with u-connectXpress software v7.0.0

Table 27: Product ordering codes

Appendix

A Glossary

Abbreviation	Definition
ADC	Analog to digital converter
BLE	Bluetooth low energy
BPF	Band pass filter
CTS	Clear to send
ESD	Electro static discharge
FCC	Federal Communications Commission
GATT	Generic ATtribute profile
GPIO	General Purpose Input/Output
IC	Industry Canada
I2C	Inter-integrated circuit
MCU	Micro controller unit
MSD	Moisture sensitive device
SPI	Serial peripheral interface
UART	Universal asynchronous receiver/transmitter

Table 28: Explanation of the abbreviations and terms used

Related documents

- [1] NINA-B1 series system integration manual, [UBX-15026175](#)
- [2] Package information, [UBX-14001652](#)
- [3] u-connectXpress AT commands manual, [UBX-14044127](#)
- [4] NINA-B1 declaration of conformity, [UBX-16022176](#)
- [5] u-connectXpress software user guide, [UBX-16024251](#)
- [6] NINA-B1 product summary, [UBX-15018552](#)

 For product change notifications and regular updates of u-blox documentation, register on our website, www.u-blox.com.

Revision history

Revision	Date	Name	Comments
R01	5-Nov-2015	ajoh, fbpro	Initial release.
R02	22-Feb-2016	ajoh	In Figure 1, replaced GPIO(s) with NFC. Modified Figure 2. Added a new section for NFC (section 2.2.2) and included pin description for NFC in Table 6 and Table 7. Added Real Time Counter section. Modified sections 2.4.2 and 2.6. Split the pin-out section into mbed/platform (section 3.1) and SPA (section 3.2) and updated these sections. Updated Figure 3. Updated NINA-B112 radio performance. Updated mechanical dimensions (section 5) Modified the number of pieces on a reel to 500 in section 8.1.1.
R03	19-Apr-2016	ajoh	Modified the supported Serial peripheral interface (section 2.4.2).
R04	17-Jun-2016	ajoh, fbpro, mhan, kgom	Renamed Serial Port Application as NINA-B11x firmware. Updated the pin-out (section 3), added extra information about NFC pins and added section 2.9. Switched places of DSR and DTR pins in B11x firmware pin-out, updated system functions text (section 2.3), added measurements to electrical specifications (section 4), and a few minor changes. Included figures for tape orientation and tape dimensions in section 8.1.2. Added approved antennas list (chapter 7). Document status changed to Advance Information.
R05	09-Aug-2016	ajoh	Added radiation patterns for NINA-B112 (section 0). Further described features tied to the u-connectXpress software (section 2.9). Added new product qualifications and type approvals (section 6), and updated the approved antennas list (chapter 7). Added information about the available debug interfaces. Changed the document status to Early Production Information.
R06	28-Feb-2017	ajoh, kgom	Added hardware and software option (sections 1.5 and 1.6). Added Bluetooth address information (section 1.7). Removed the 'supported features' section and table. Clarified the module pinout used by the u-connectXpress software. Added information about the exposed GND pins in the center of the module in section 3. Corrected information in Table 7 (SWITCH_1 is not used to restore UART settings). Added current consumption data when powering NINA-B1 with 1.8 V in Table 13. Added detailed tolerances information to the mechanical dimensions (section 5). Added type approval information for Taiwan, South Korea, Brazil, Australia/New Zealand, and South Africa (section 6). Corrected a typo in Table 16 (max value for high level input characteristic is VCC, not 0) and in Table 5 (blue RGB led color is caused by low signal on BLUE not RED). On page 2, added type numbers for u-connectXpress software v2.0.0; replaced Document status with Disclosure restriction.
R07	16-May-2017	kgom	Minor updates.
R08	29-Jun-2017	ajoh, kgom	Updated Table 1. Updated product status to Mass Production. Added more information in the Block Diagram (Figure 1). Added information about I2S (section 0) and PWM interfaces. Increased the number of analog capable pins to 8 (previously 7); the new pin was previously intended for another use. Updated section 3.1. Included ordering codes for -02B version in Table 27 and type numbers on page 2. In section 2.9, clarified that system signals indicate SPS connections only and added information about how the DTR pin can be used. Added information about the contents of the label DataMatrix bar code to Table 24.
R09	24-Apr-2018	ajoh, lalb, kgom	Added new software version 4.0.0: New ordering codes/type numbers in the last table on page 2. Updated Table 1 and section 2.9 with new features. Added information about IO signals. Added I/O signals to the pin-out for u-connectXpress software (Table 7) (used to be RSVD). Included ordering codes for -03B version in Table 27. Included support for Bluetooth version 5. Clarified information on Bluetooth qualification (section 6.10) and included Bluetooth v5 QD ID. Added notes that country approvals for Bluetooth 5 are still pending for Japan and Korea. A few minor changes based on the latest brand guidelines of Arm Mbed. Updated the product status for the ordering codes/type numbers ending with -02B-00 to Mass Production in the last table on page 2.

Revision	Date	Name	Comments
R10	8-Aug-2018	lalb, kgom	Updated that the country approvals for Bluetooth 5 in Japan and Korea have been completed (by removing the notes that those country approvals previously were pending).
R11	21-Nov-2018	kgom	Updated the product status for the ordering codes/type numbers ending with -03B-00 to Mass Production in the last table on page 2.
R12	2-Jan-2019	ajoh	Changed the format of the approved antennas list (chapter 7) to align with other u-blox products.
R13	5-Mar-2019	hisa	Added new software version 5.0.0, new ordering codes/type numbers in the last table on page 2 and in Table 25. Replaced "u-blox connectivity software" with "u-connectXpress software" in all instances. Replaced Getting Started reference with u-connectXpress guide.
R14	29-Oct-2019	asoh, ajoh, kgom	Updated Table 1 Corrected the typographical error for dimension "R" in mechanical specifications (section 5). Added hardware version numbers for all products in the "applicable products" table on page 2. Updated the RoHS compliance to Directive 2015/863/EU (RoHS 3) (section 6.1.1). Updated description of data matrix module type number.
R15	13-Nov-2020	ajoh	NINA-B11X-04B is now in mass production status.
R16	5-Aug-2021	fkru, hisa, hekf, asoh	Updated NINA-B11X-04B production status. Added SRRC certification for NINA-B11. Added new software version 7.0.0 and ordering codes. Updated names for ProAnt Ex-It series antennas and FlatWhip EOL in the Approved antennas list. Added new section to describe the GPIO drive mode configuration that allows increased draw of the digital output current. Updated System functions section. Added warning against exceeding the maximum output power limitations. Updated references to previously obsolete documents. Added warning related to RAM data retention. Added miscellaneous editorial changes in several sections.

Contact

For complete contact information, visit us at www.u-blox.com.

u-blox Offices

North, Central and South America

u-blox America, Inc.

Phone: +1 703 483 3180

E-mail: info_us@u-blox.com

Regional Office West Coast:

Phone: +1 408 573 3640

E-mail: info_us@u-blox.com

Technical Support:

Phone: +1 703 483 3185

E-mail: support@u-blox.com

Headquarters

Europe, Middle East, Africa

u-blox AG

Phone: +41 44 722 74 44

E-mail: info@u-blox.com

Support: support@u-blox.com

Asia, Australia, Pacific

u-blox Singapore Pte. Ltd.

Phone: +65 6734 3811

E-mail: info_ap@u-blox.com

Support: support_ap@u-blox.com

Regional Office Australia:

Phone: +61 3 9566 7255

E-mail: info_au@u-blox.com

Support: support_ap@u-blox.com

Regional Office China (Beijing):

Phone: +86 10 68 133 545

E-mail: info_cn@u-blox.com

Support: support_cn@u-blox.com

Regional Office China (Chongqing):

Phone: +86 23 6815 1588

E-mail: info_cn@u-blox.com

Support: support_cn@u-blox.com

Regional Office China (Shanghai):

Phone: +86 21 6090 4832

E-mail: info_cn@u-blox.com

Support: support_cn@u-blox.com

Regional Office China (Shenzhen):

Phone: +86 755 8627 1083

E-mail: info_cn@u-blox.com

Support: support_cn@u-blox.com

Regional Office India:

Phone: +91 80 405 092 00

E-mail: info_in@u-blox.com

Support: support_in@u-blox.com

Regional Office Japan (Osaka):

Phone: +81 6 6941 3660

E-mail: info_jp@u-blox.com

Support: support_jp@u-blox.com

Regional Office Japan (Tokyo):

Phone: +81 3 5775 3850

E-mail: info_jp@u-blox.com

Support: support_jp@u-blox.com

Regional Office Korea:

Phone: +82 2 542 0861

E-mail: info_kr@u-blox.com

Support: support_kr@u-blox.com

Regional Office Taiwan:

Phone: +886 2 2657 1090

E-mail: info_tw@u-blox.com

Support: support_tw@u-blox.com