

## Overview

The KEMET MA compact plastic PCB mount filters cover single-phase requirements with a wide variety of characteristics. These filters are optimized for conduction noise.

## Applications

- Industrial equipment
- Electronic equipment

## Benefits

- Single-phase 250 VAC
- Current range from 1 to 5 A
- Operating temperature range from -25°C to +55°C
- UL, CSA, and TÜV approved
- RoHS compliant



## Part Number System

MA-	2	01	3
Series	Phase	Rated Current (A)	Specification
MA	2 = Single-phase	0x = 0x A	3 = Standard

## Dimensions – Millimeters

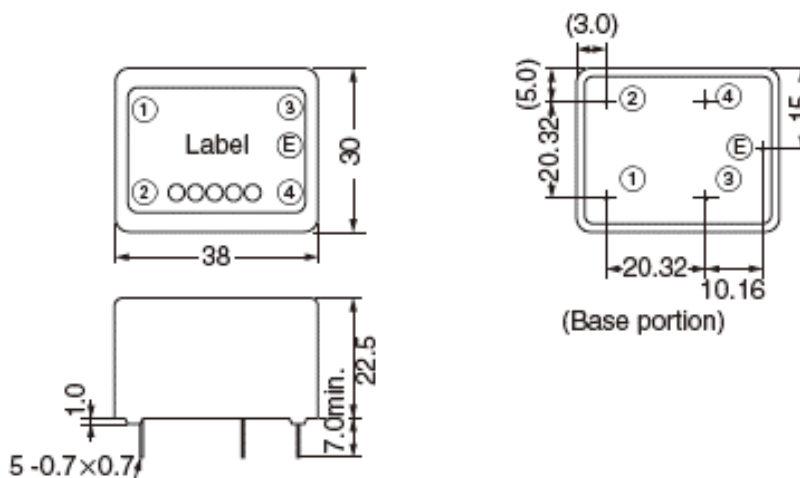

## Environmental Compliance

All KEMET MA EMI-RFI Filters are RoHS compliant.



## Approvals

Certification Body	File Number	Part Number
UL	E59551	MA-2013, MA-2023, MA-2033, MA-2043 and MA-2053
CSA	LR50413	MA-2013, MA-2023, MA-2033, MA-2043 and MA-2053
TÜV Rheinland Japan Ltd.	R50015843	MA-2013, MA-2023, MA-2033, MA-2043 and MA-2053

## Performance Characteristics

Item	Performance Characteristics
Rated Voltage	250 V
Rated Current Range	1 – 5 A
Withstanding Voltage	1,500 VAC (1 minute, line to ground)
Insulation Resistance	300 MΩ minimum at 500 VDC (1 minute, line to ground)
Leakage Current	0.75 mA maximum at 250 V/60 Hz
Input/Output Terminal Type	PCB mount
Operating Temperature Range	-25°C to +55°C (not including self temperature rise)

**Table 1 – Ratings & Part Number Reference**

Part Number	Phase	Rated Voltage AC/DC (V)	Rated Current AC/DC (A)	Leakage Current at 250 V/60 Hz (mA) Maximum	Temperature Rise (K) Maximum	Operating Temperature Range	Terminal Type	Approval	Weight (g)
MA-2013	Single-phase	250	1	0.75	30	-25°C to +55°C	PCB mount	UL, CSA and TÜV	30
MA-2023	Single-phase	250	2	0.75	30	-25°C to +55°C	PCB mount	UL, CSA and TÜV	30
MA-2033	Single-phase	250	3	0.75	30	-25°C to +55°C	PCB mount	UL, CSA and TÜV	30
MA-2043	Single-phase	250	4	0.75	30	-25°C to +55°C	PCB mount	UL, CSA and TÜV	30
MA-2053	Single-phase	250	5	0.75	30	-25°C to +55°C	PCB mount	UL, CSA and TÜV	30

## Circuit Diagram

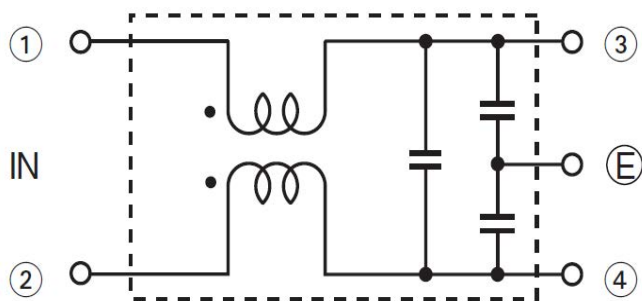

## Measuring Circuit - Common Mode

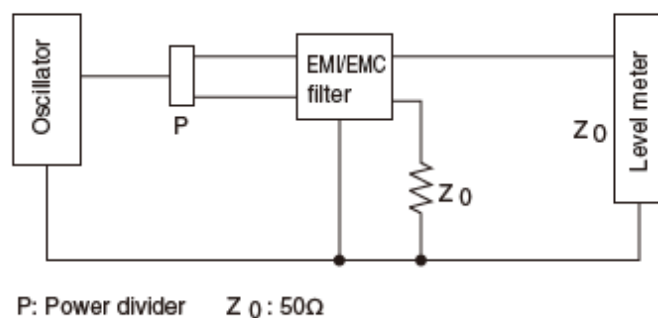

## Attenuation (Static Characteristics)

**MA-2013**

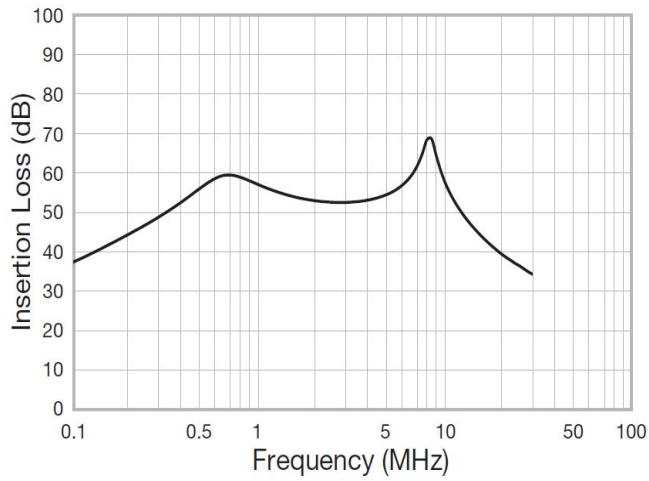

**MA-2023**

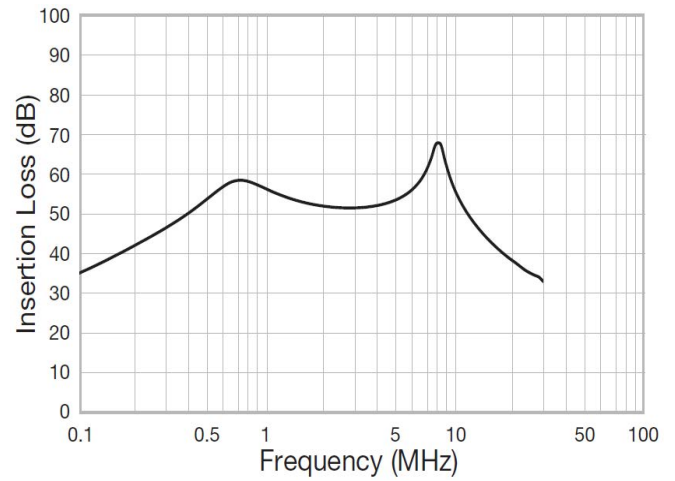

**MA-2033**

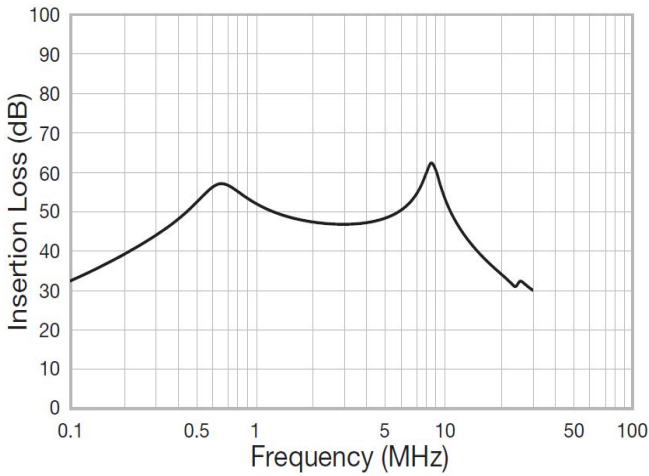

**MA-2043**

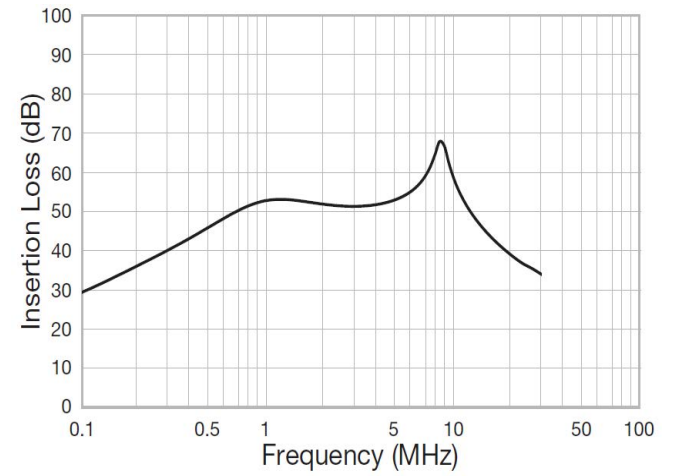

**MA-2053**

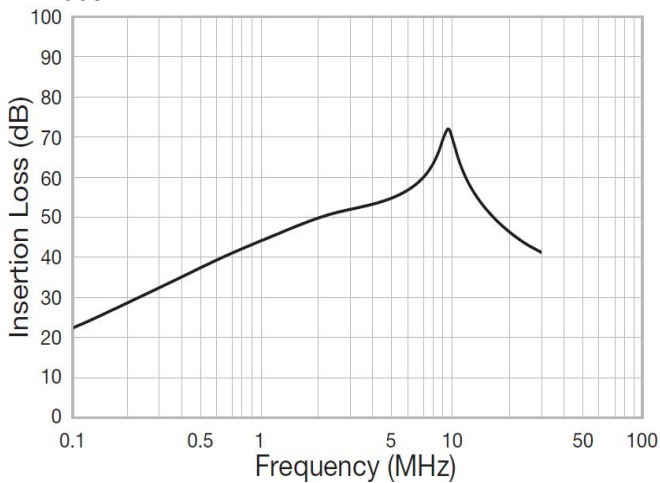

## Packaging

Part Type	Packaging Type	Pieces per Box
MA-20*3	Tray	50

## Handling Precautions

### Precautions for product storage

EMI-RFI Filters should be stored in normal working environments. While the filters themselves are quite robust in other environments, solderability will be degraded by exposure to high temperatures, high humidity, corrosive atmospheres, and long term storage.

KEMET recommends that maximum storage temperature not exceed 40°C and maximum storage humidity not exceed 70% relative humidity and atmospheres should be free of chlorine and sulfur bearing compounds. Temperature fluctuations should be minimized to avoid condensation on the parts. Also, avoid storage near strong magnetic fields as this might magnetize the product.

For optimized solderability, EMI-RFI Filters' stock should be used promptly, preferably within 6 months of receipt.

## KEMET Electronics Corporation Sales Offices

For a complete list of our global sales offices, please visit [www.kemet.com/sales](http://www.kemet.com/sales).

---

### Disclaimer

YAGEO Corporation and its affiliates do not recommend the use of commercial or automotive grade products for high reliability applications or manned space flight.

All product specifications, statements, information and data (collectively, the "Information") in this datasheet are subject to change. The customer is responsible for checking and verifying the extent to which the Information contained in this publication is applicable to an order at the time the order is placed. All Information given herein is believed to be accurate and reliable, but it is presented without guarantee, warranty, or responsibility of any kind, expressed or implied.

Statements of suitability for certain applications are based on KEMET Electronics Corporation's ("KEMET") knowledge of typical operating conditions for such applications, but are not intended to constitute – and KEMET specifically disclaims – any warranty concerning suitability for a specific customer application or use. The Information is intended for use only by customers who have the requisite experience and capability to determine the correct products for their application. Any technical advice inferred from this Information or otherwise provided by KEMET with reference to the use of KEMET's products is given gratis, and KEMET assumes no obligation or liability for the advice given or results obtained.

Although KEMET designs and manufactures its products to the most stringent quality and safety standards, given the current state of the art, isolated component failures may still occur. Accordingly, customer applications which require a high degree of reliability or safety should employ suitable designs or other safeguards (such as installation of protective circuitry or redundancies) in order to ensure that the failure of an electrical component does not result in a risk of personal injury or property damage.

Although all product-related warnings, cautions and notes must be observed, the customer should not assume that all safety measures are indicated or that other measures may not be required.

When providing KEMET products and technologies contained herein to other countries, the customer must abide by the procedures and provisions stipulated in all applicable export laws and regulations, including without limitation the International Traffic in Arms Regulations (ITAR), the US Export Administration Regulations (EAR) and the Japan Foreign Exchange and Foreign Trade Act.

*KEMET is a registered trademark of KEMET Electronics Corporation.*