

Features

- 5 x 3 x 1 Inches Form factor
- 350 Watts Forced Cooled & 200 Watts Convection Cooled
- Efficiencies upto 94% & No Load Power < 0.5W
- -40 to 70 degree operating temperature*
- 12V / 0.5A Fan Output, Thermal Shut-Down feature
- 2.56m Hours, Telcordia -SR332-issue 3 MTBF
- Remote ON/OFF **New**
- Now IEC/EN/UL62368-1:2018 (Ed 3.0) Certified **New**
- IEC/EN61558 Compliant **New*****

(Suitable for Household and Similar electrical equipment's certified under IEC/EN60335-1 standards)

- Approved with metal enclosures/accessories

Electrical Specifications

Input Voltage	90-264 VAC/390 VDC, Universal (Derate from 100% at 100V AC to 90% at 90V AC)	
Input Frequency	47-63 Hz	
Input Current	115 VAC: 3.6 A max.	230 VAC: 1.8 A max.
No Load Power	less than 0.5W typical	
Inrush Current	115 VAC – 25 A, 230 VAC – 45 A, 264 VAC – 75 A	
Leakage Current	300 uA Typical	
Efficiency	94%(48V,58V), 93%(24V,30V), 92%(12V,15V)	
Hold-up Time	Full Load > 8 ms typical	Convection Load > 14 ms typical
Power Factor	exceeds 0.95 with Full Load	
Output Power	upto 350W with 375 LFM, upto 200W Convection	
Output Voltage Adjustability	+/-3%	
Line Regulation	+/-0.5%	
Load Regulation	+/-1%	
Transient Response	50-100% step load change, at 0.1A/uS slew rate, 50% duty cycle, 50Hz=5% , recovery time < 5 ms	
Rise Time	55 ms typical	
Set Point Tolerance	+/-1%	
Over Current Protection	>110% ,Hiccup mode / Auto Recovery	
Over Voltage Protection	110 to 140% , Hiccup mode / Auto Recovery	
Short Circuit Protection	Hiccup mode / Auto Recovery	
Switching Frequency	PFC – 70 to 130 KHz ,PWM – 50-80 KHz	
Operating Temperature	-40 to +70°C, * -40 to 0°C startup is guaranteed with spec deviation (ref note 6)	
Storage Temperature	-40 to +85°C	
Relative Humidity	5% to 95%, noncondensing	
Altitude	Operating: 16,000 ft.; Nonoperating: 40,000 ft.	
MTBF	2.56m Hours, Telcordia -SR332-issue 3	
Isolation Voltage	Input to Output – 4000 VDC for ITE application, Input to GND - 2500 VAC	
Cooling	350W with 375 LFM forced air cooling at 100 to 264VAC 200W with natural convection cooling at 100 to 264VAC.	

Model Number	Power Supply Unit & its Installation Type	Power	Voltage	Max. Load (Convection)	Max. Load (Convection) (375 LFM)
FWLWP350-1X01-CK	In CK cover Kit	126 W	12 V	10.5 A	-
FWLWP350-1301 ⁷	In Open Frame	225 W	12 V	15 A	18.75 A
FWLWP350-1301-L	With L Bracket				
FWLWP350-1301-B	With Base Plate				
FWLWP350-1301-U	With U channel				
FWLWP350-1001	In Open Frame	300 W	12 V	15 A	25 A
FWLWP350-1001-L	With L Bracket				
FWLWP350-1001-B	With Base Plate				
FWLWP350-1001-U	With U channel				
FWLWP350-1X02-CK	In CK cover Kit	126 W	15 V	8.4 A	-
FWLWP350-1302 ⁷	In Open Frame	270 W	15 V	12A	18 A
FWLWP350-1302-L	With L Bracket				
FWLWP350-1302-B	With Base Plate				
FWLWP350-1302-U	With U channel				
FWLWP350-1002	In Open Frame	325 W	15 V	12 A	21.67 A
FWLWP350-1002-L	With L Bracket				
FWLWP350-1002-B	With Base Plate				
FWLWP350-1002-U	With U channel				
FWLWP350-1X03-CK	In CK cover Kit	140 W	24 V	5.83 A	-
FWLWP350-1X03	In Open Frame	350 W	24 V	8.33 A	14.60 A
FWLWP350-1X03-L	With L Bracket				
FWLWP350-1X03-B	With Base Plate				
FWLWP350-1X03-U	With U channel				
FWLWP350-1X04-CK	In CK cover Kit	140 W	48 V	2.92 A	-
FWLWP350-1X04	In Open Frame	350 W	48 V	4.17 A	7.30 A
FWLWP350-1X04-L	With L Bracket				
FWLWP350-1X04-B	With Base Plate				
FWLWP350-1X04-U	With U channel				
FWLWP350-1X05-CK	In CK cover Kit	140 W	30 V	4.67 A	-
FWLWP350-1X05	In Open Frame	350 W	30 V	6.67 A	11.67 A
FWLWP350-1X05-L	With L Bracket				
FWLWP350-1X05-B	With Base Plate				
FWLWP350-1X05-U	With U channel				
FWLWP350-1X06-CK	In CK cover Kit	140 W	58 V	2.39 A	-
FWLWP350-1X06-CK	In Open Frame	350 W	58 V	3.42 A	6.04 A
FWLWP350-1X06-L	With L Bracket				
FWLWP350-1X06-B	With Base Plate				
FWLWP350-1X06-U	With U channel				

For Screw Terminal version replace "X" above with "0" (example: FWLWP350-1005)

For Header version replace "X" above with "3" (example: FWLWP350-1305)

Add Suffix 'O' for Remote On/Off option (example: FWLWP350-1304-0)



Pin Connection		
J1	Pin 1	AC LINE
	Pin 2	NOT FITTED
	Pin 3	AC NEUTRAL
J2 Option 1 (Screw Terminal)	Pin 1	V1 +VE
	Pin 2	V1 -VE
J2 Option 2 (Molex Connector)	Pin 1,2,3,4	V1 +VE
	Pin 5,6,7,8	V1 -VE
J3	Pin 1	FAN +VE
	Pin 2	FAN -VE
J6 (Remote On/Off)	Pin 1	+VE (External)
	Pin 2	-VE (External)

REMOTE ON/OFF INHIBIT

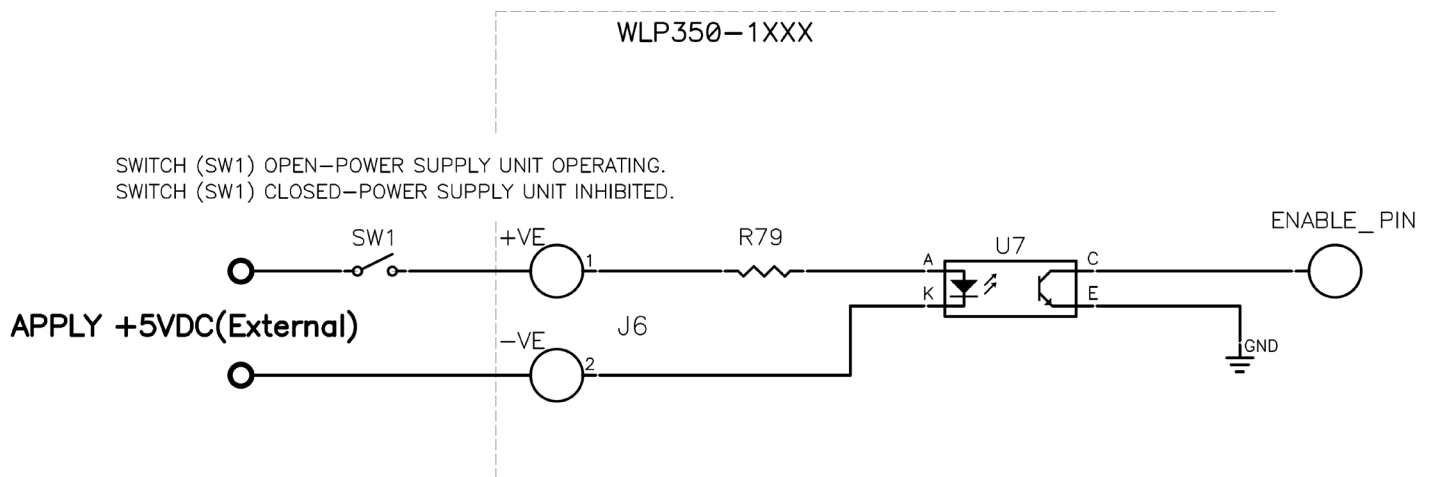

Note : External supply voltage can be changed with pre Information

Notes

1. Ripple is peak to peak with 20 MHz bandwidth and 10 μ F (Electrolytic capacitor) in parallel with a 0.1 μ F capacitor at rated line voltage and load ranges.
2. Combined output power of main output, fan supply shall not exceed max. Power rating.
3. Fan supply output voltage tolerance including set point accuracy, line and load regulation is +/-10% and Ripple and noise is less than 10%.
4. Specifications are for nominal input voltage, 25°C unless otherwise stated.
5. Thermal shutdown feature : The power supply goes in hiccup mode when the temperature of PCB exceeds 110 °C (+/-10 °C).
6. Output ripple can be more than 10% of the output voltage.
7. When used in Cover Kit, de-rate output power to 70 % under all operating conditions.
8. Class II version available.Add "-II" suffix at the end of the Model Number to Order.
9. For more information and pricing details, please contact our sales team.

Mechanical Specifications

AC Input Connector (J1)	Molex: 26-60-4030 Mating: 09-50-3031; Pins: 08-50-0106
Earth (J4)	Molex: 19705-4301 Mating: 19003-0001
DC Output Connector (J2) Option 1 (Screw Terminal)	6-32 inches Screw Pan HD Mating: Designed to accept Ring Tongue Terminal AMP : 8-31886-1, wherein one 16 AWG(max) wire can be crimped. Note : One Ring Tongue Terminal with 16 AWG is recommended for current upto 11A only. Use multiple tongue terminals with wire for more current.
DC Output Connector (J2) Option 2 (Molex Connector)	Molex: 26-60-4080 Mating: 09-50-3081; Pins: 08-50-0106
Aux (Fan) Output(J3) Remote ON/OFF (J6)	AMP :640456-2 Mating: 640440-2
Dimensions	5 x 3 x 1 inches (127 x 76.2x 25.4 mm)
Weight	300 gm approx

EMC

Parameter	Conditions/Description	Criteria
Conducted Emissions	EN55032-B, CISPR22-B, FCC PART15-B	Pass
Radiated Emissions	EN 55032 A	Pass Level B with external core (King core K5B RC 25x12x15-M in input cable)
Input Current Harmonics	EN 61000-3-2	Class D
Voltage Fluctuation and Flicker	EN 61000-3-3	Pass
ESD Immunity	EN 61000-4-2	Level 3, Criterion A
Radiated Field Immunity	EN 61000-4-3	Level 3, Criterion A
Electrical Fast Transient Immunity	EN 61000-4-4	Level 3, Criterion A
Surge Immunity	EN 61000-4-5	Level 4, Criterion A
Conducted Immunity	EN 61000-4-6	Level 3, Criterion A
Magnetic Field Immunity	EN 61000-4-8	Level 3, Criterion A
Voltage dips, interruptions	EN 61000-4-11	Criterion A & B

Safety

CE Mark	Complies with LVD Directive
Approval Agency	Nemko, UL, C-UL
Safety Standard(s)	IEC 62368-1:2018, IEC 61558-1:2005, IEC 61558-1:2005/AMD1:2009, IEC 61558-2-16:2009, IEC 61558-2-16:2009 /AMD1:2013, IEC 60950-1(ed.2);am1;am2, EN 61558-2-16:2009;A1, EN 61558-1:2005;A1, UL 62368-1 and CAN/CSA C22.2 No. 62368-1:19, GB 17625.1-2012; GB 4943. 1-2011; GB/T 9254-2008
Safety File Number(s)	Class-I : UL: Certificate Number 20200430-E514578, Nemko: Certificate No. P19223410, CB Certificate No.: NO110346, CCC Certificate No.: 2015010907830085

Derating Curve

Power de-rating : 12V output for Open Frame/Base Plate/L Bracket/U Channel

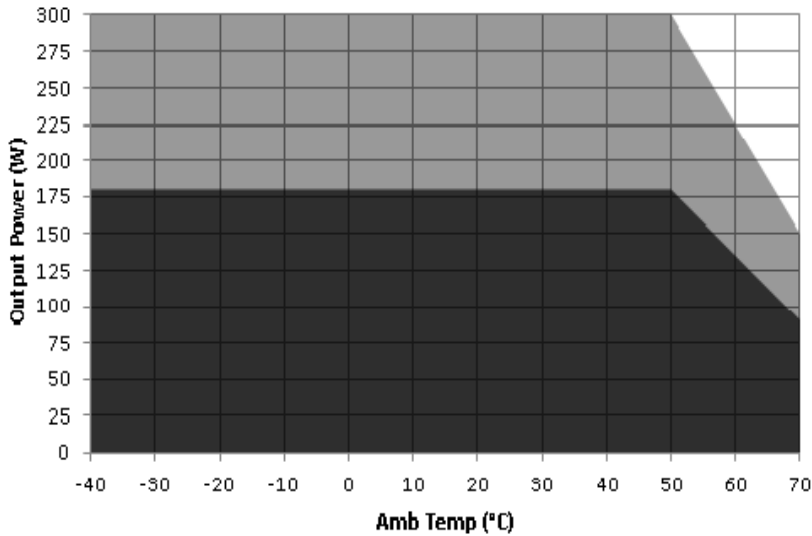

Convection load: 180W up to 50 °C
De-rate above 50 °C @ 2.5% per °C

Forced air cooled load: 300W up to 50°C
De-rate above 50 °C @ 2.5% per °C

■ Forced air
■ Convection

Derating Curve

Power de-rating : 15V output for Open Frame / Base Plate / L Bracket/U Channel

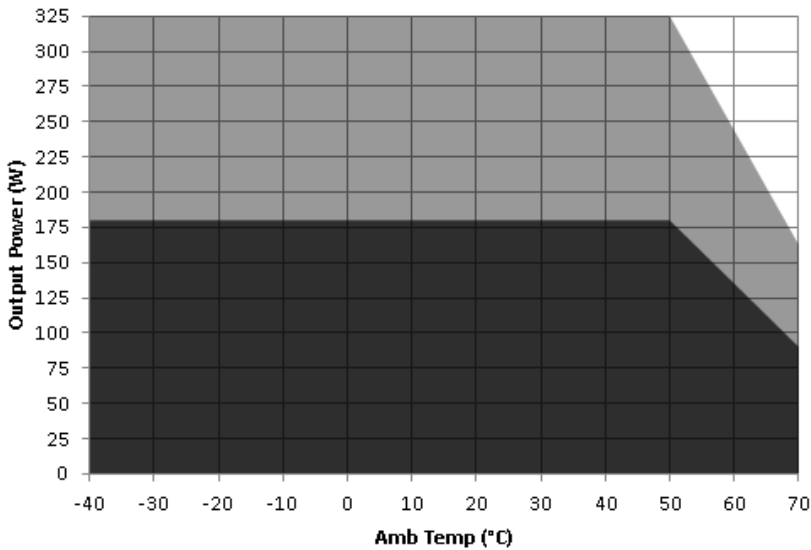

Convection load: 180W up to 50 °C
De-rate above 50 °C @ 2.5% per °C

Forced air cooled load: 325W up to 50°C
De-rate above 50 °C @ 2.5% per °C

■ Forced air
■ Convection

Derating Curve Note : Between -40 to 0°C startup is guaranteed with spec deviation (ref note 6)



Derating Curve

Power de-rating : 24V, 30V, 48V, 58V outputs for Open Frame/Base Plate/L Bracket/U Channel

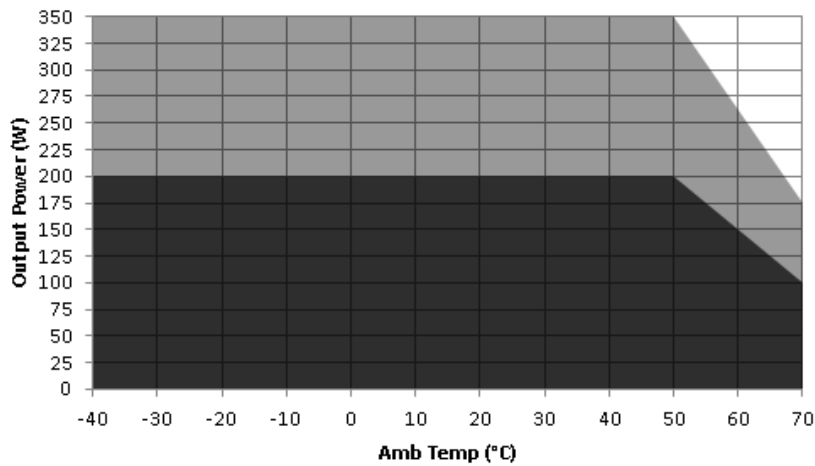

Convection load: 200W up to 50 °C
De-rate above 50 °C @ 2.5% per °C

Forced air cooled load : 350W up to 50°C
De-rate above 50 °C @ 2.5% per °C

■ Forced air
■ Convection

Derating Curve

Power de-rating : 12V,15V outputs with CK cover kit

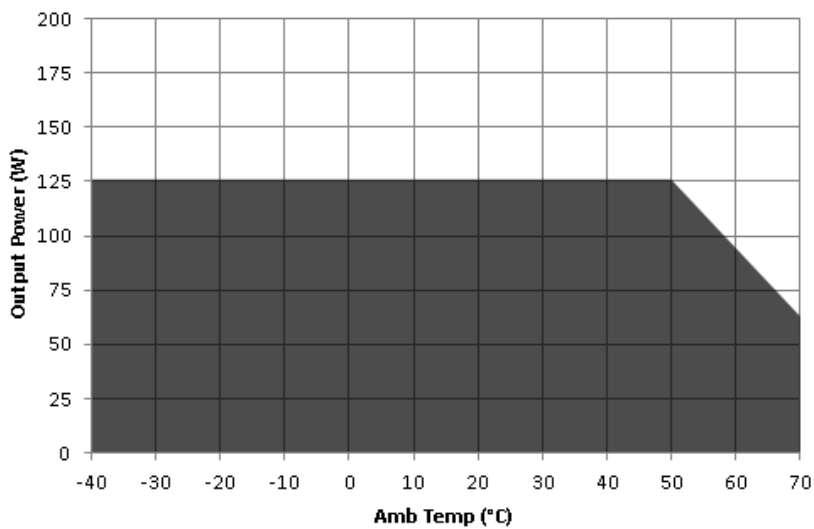

Convection load: 126W up to 50 °C
De-rate above 50 °C @ 2.5% per °C

■ Convection

Derating Curve

Power de-rating : 24V, 30V, 48V, 58V outputs with CK cover kit

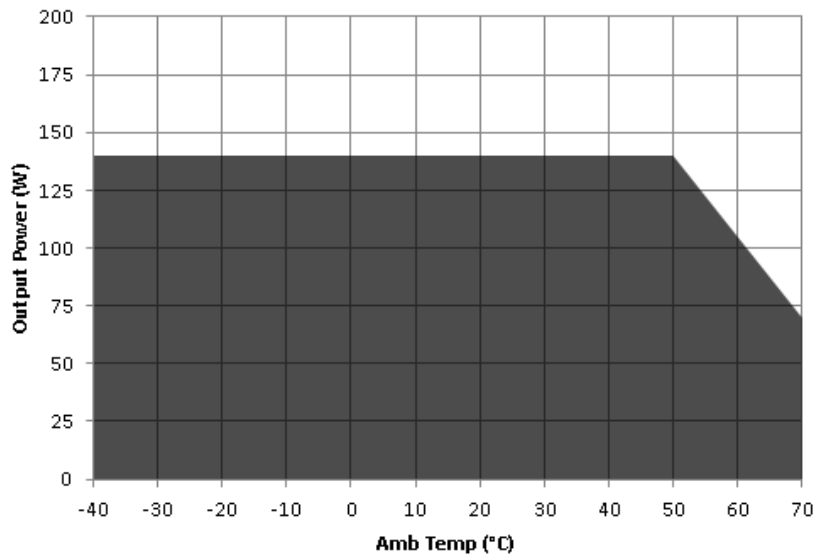

Convection load: 140W up to 50 °C
De-rate above 50 °C @ 2.5% per °C

■ Convection

Mechanical Drawing

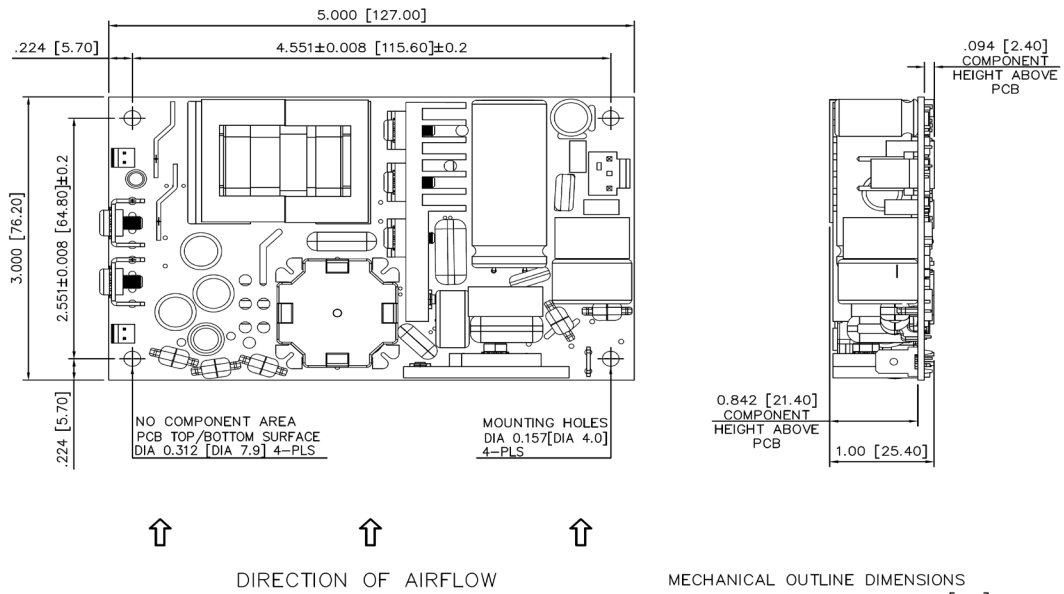

Notes: In case the PCB is mounted in a metal enclosure, using metal hardware ensure the following

1. Stand off, used to mount PCB has OD of 5.4 mm max.
2. Screws, used to fix PCB on stand off, have head dia of 6.0 mm max.
3. Washer, if used, to have dia of 6.5 mm max.

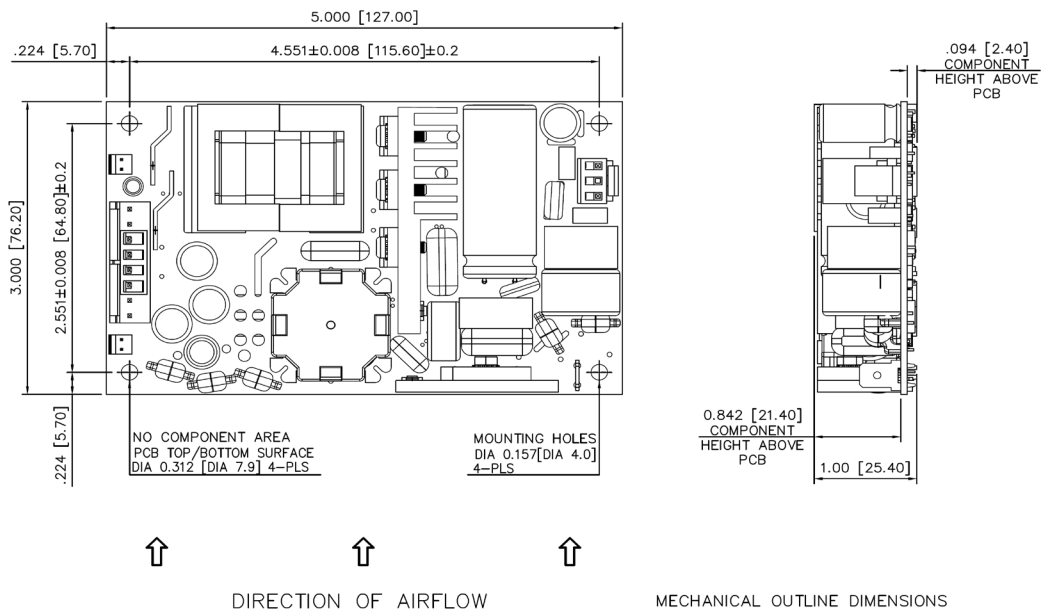

Notes: In case the PCB is mounted in a metal enclosure, using metal hardware ensure the following

1. Stand off, used to mount PCB has OD of 5.4 mm max.
2. Screws, used to fix PCB on stand off, have head dia of 6.0 mm max.
3. Washer, if used, to have dia of 6.5 mm max.

Mechanical Drawing

WLP350 SERIES WITH BASE PLATE

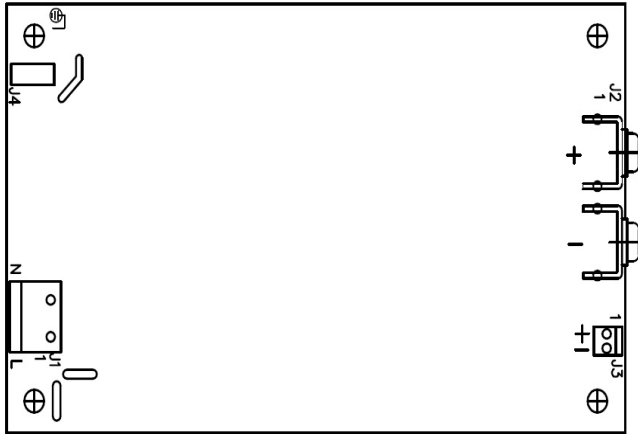

OPTION 1
-10XX SUFFIX.

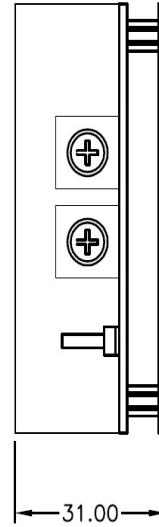

OPTION 2
-13XX SUFFIX.

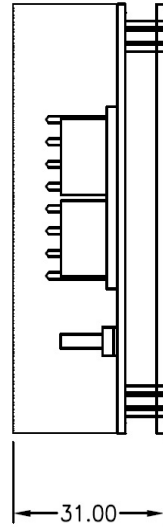

"A" CUSTOMER MOUNTING HOLES
4-PLACES, THREAD M3x0.5
3.0 MAX.PENETRATION

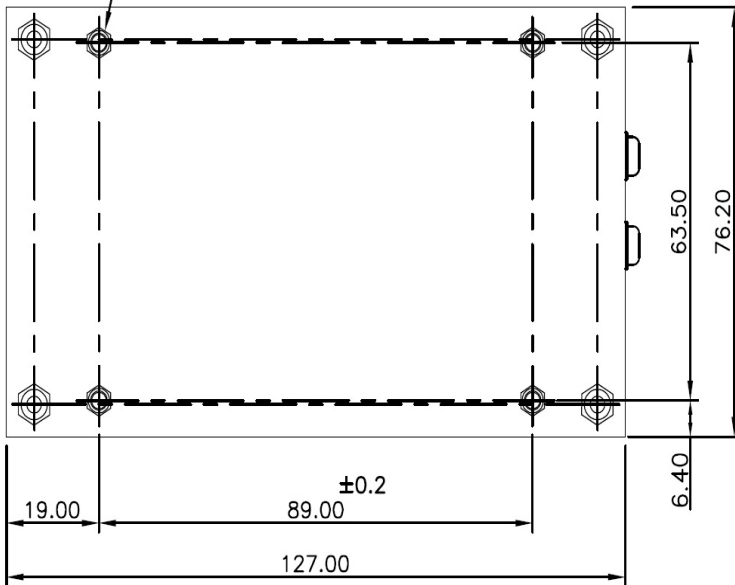

MECHANICAL OUTLINE DIMENSIONS
ALL DIMENSIONS ARE IN MM
GEN.TOLERANCE: +/-0.5 MM

Mechanical Drawing

WLP350 SERIES WITH 'L' BRACKET

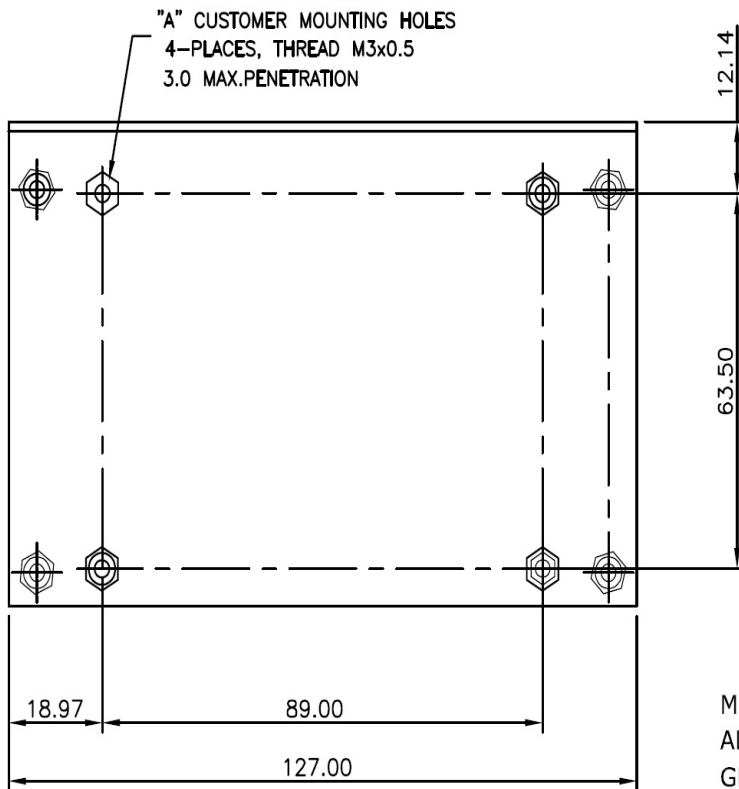
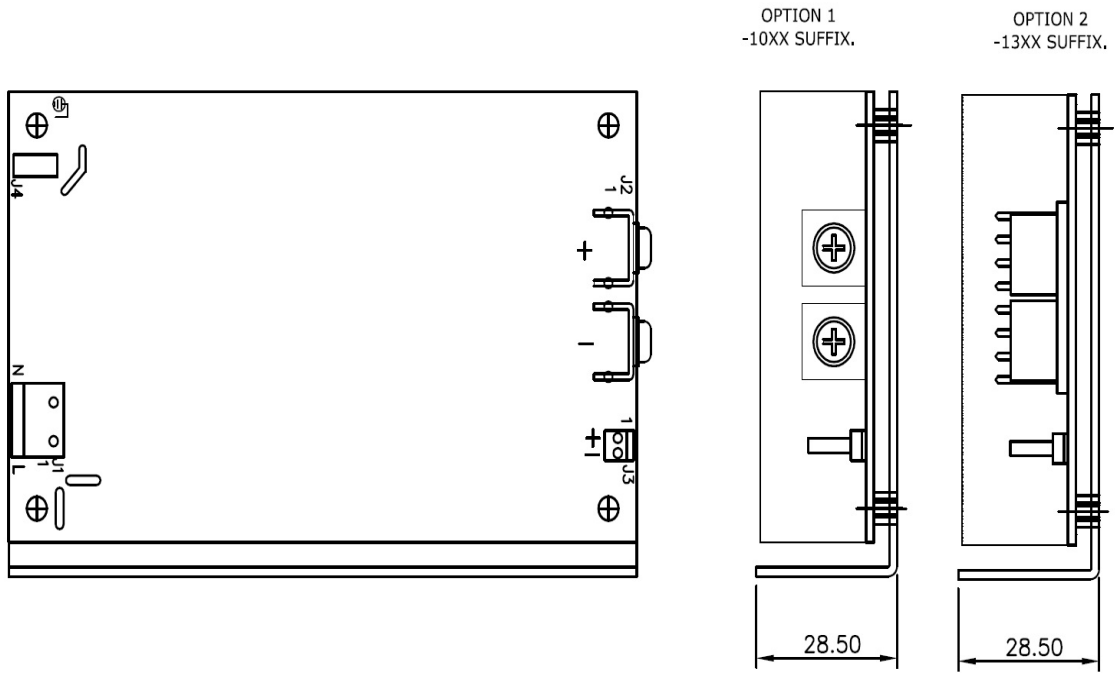

MECHANICAL OUTLINE DIMENSIONS
ALL DIMENSIONS ARE IN MM
GEN.TOLERANCE: +/-0.5 MM

Mechanical Drawing

WLP350 SERIES WITH 'U' CHANNEL

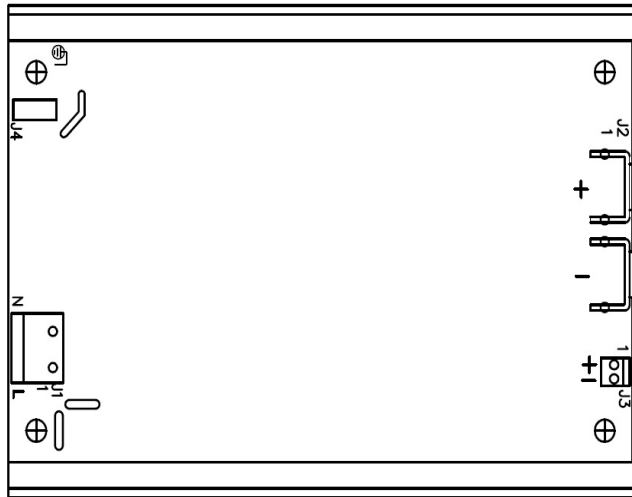

OPTION 1
-10XX SUFFIX.

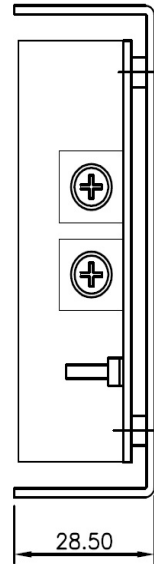

OPTION 2
-13XX SUFFIX.

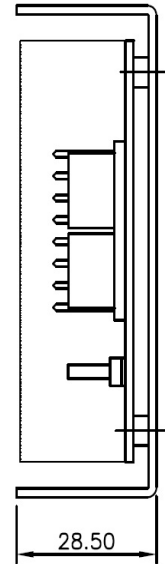

"A" CUSTOMER MOUNTING HOLES
4-PLACES, THREAD M3x0.5
3.0 MAX.PENETRATION

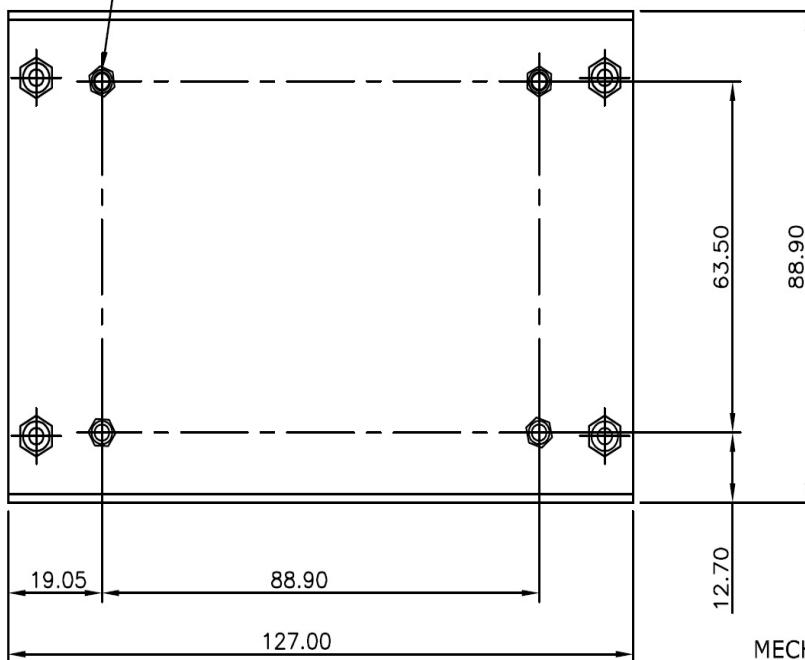

MECHANICAL OUTLINE DIMENSIONS
ALL DIMENSIONS ARE IN MM
GEN.TOLERANCE: +/-0.5 MM

Mechanical Drawing

WLP350-1002-CK WITH COVER KIT

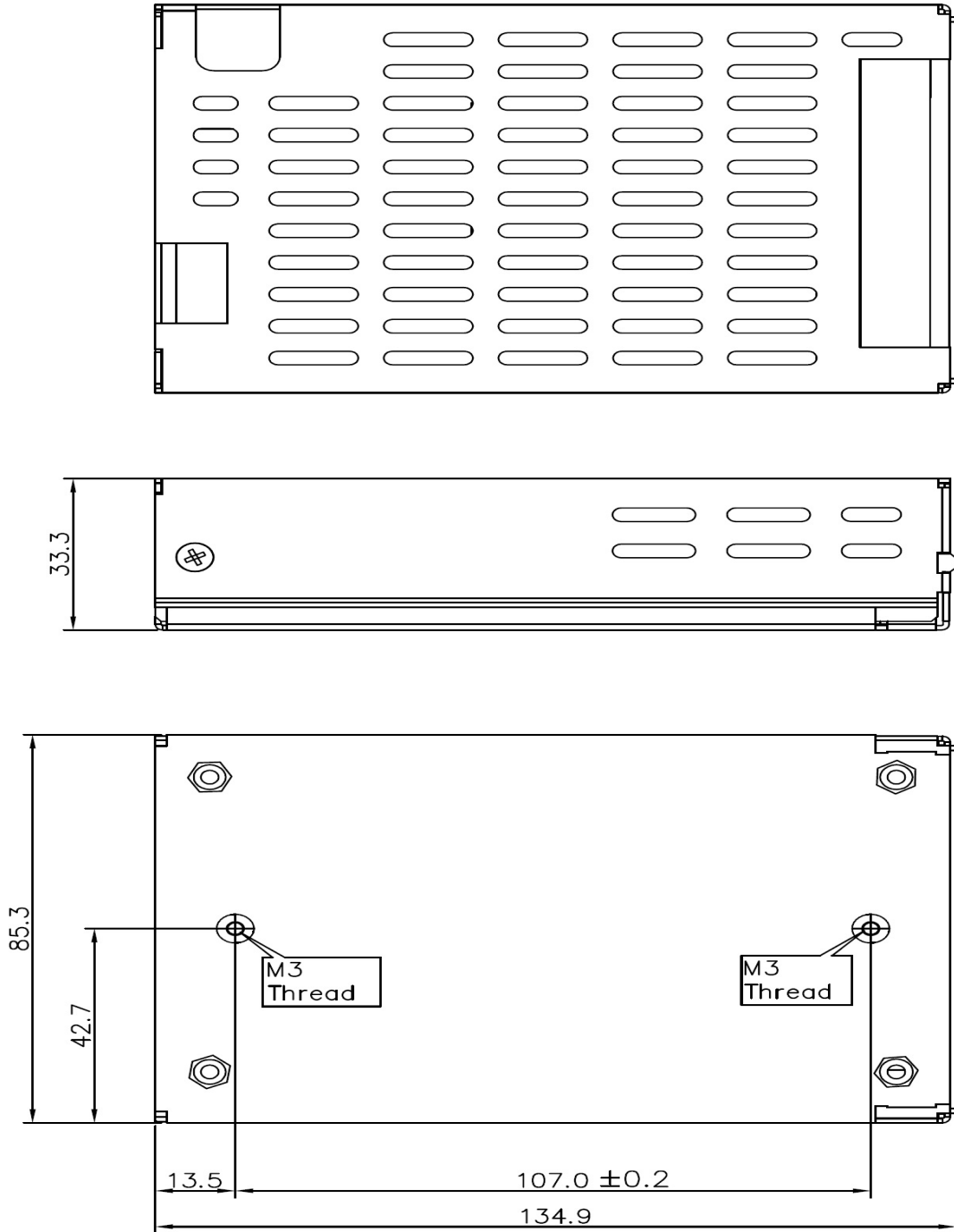

MECHANICAL OUTLINE DIMENSIONS
ALL DIMENSIONS ARE IN MM.
GEN. TOLERANCE: ±1.0 mm

Mechanical Drawing

WLP350 SERIES WITH REMOTE ON/OFF

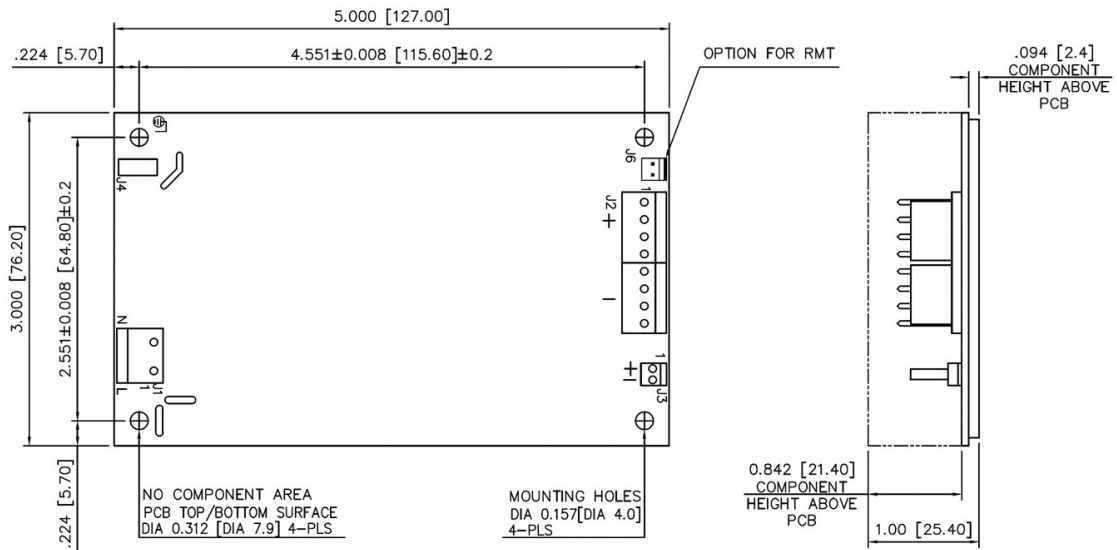

DIRECTION OF AIRFLOW

MECHANICAL OUTLINE DIMENSIONS
ALL DIMENSIONS ARE IN INCHES[MM]
GEN TOLERANCE : +/-0.04[+/-1.0MM]