

MLX90824

Absolute Pressure Sensor with SENT output
Datasheet

1. Features and Benefits

- +/-0.5% full scale lifetime accuracy
- Digital SENT output
- Option to output linear temperature measured by external NTC thermistor
- Flexible NTC input supports wide range of different NTC characteristics without calibration
- All-in-one solution: MEMS, interface and passive components in one easy to integrate package validated according to leading OEM EMC standards
- -40°C to 160°C temperature range, up to 170°C for short durations
- Excellent harsh media resistance against halogens, acids, ...
- Qualified according to AEC-Q100 and AEC-Q103-002
- Configurable diagnostic features like output out of range, over voltage, under voltage, ...
- Factory calibrated and fully programmable through the connector with the PTC04 programming tool for customized calibration curves
- Extended over (+40V) and reverse (-40V) voltage capabilities (supply & output)
- Easy to use due to its PCB-less package with ridges to enable glued pressure seals
- ASIL compliant developed as an ASIL B SEooC as per ISO 26262



2. Application Examples

- Automotive applications with absolute pressure from 1 bar to 4 bar
- MAP, TMAP and air management for automotive, truck and motorcycle applications
- CNG/LPG injectors

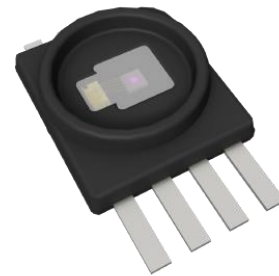

Figure 1: MLX90824

MLX90824

Absolute Pressure Sensor with SENT output
Datasheet

3. Ordering Information

Ordering Code	Temperature	Package	Option code	Packing
MLX90824GXP-DAC-300-RE	-40°C to 160°C	SMP7	0.1 to 1.15bar absolute pressure / 193 to 3896LSB SENT output / NTC	Reel
MLX90824GXP-DAD-301-RE	-40°C to 160°C	SMP7	0.1 to 3bar absolute pressure / 193 to 3896LSB SENT output / NTC	Reel
MLX90824GXP-DAD-302-RE	-40°C to 160°C	SMP7	0.1 to 4bar absolute pressure / 193 to 3896LSB SENT output / NTC	Reel

MLX90824GXP-DAC-300-RE

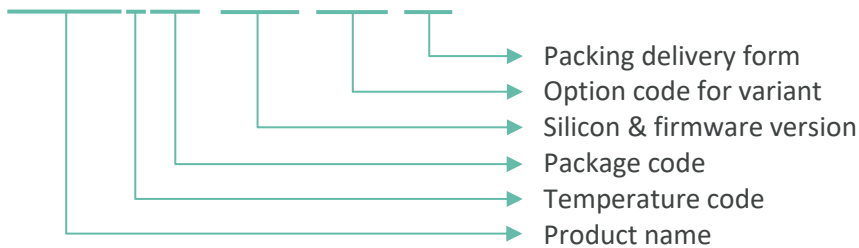

4. Package Diagram

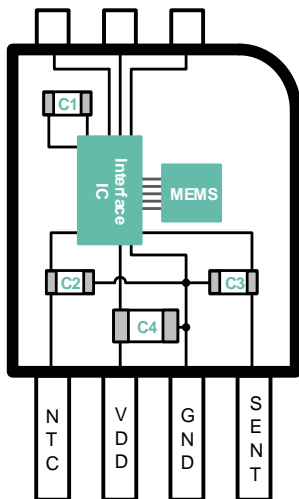

Component	Value
C1	100nF
C2	10nF
C3	2.2nF
C4	100nF

Table 1: MLX90824 capacitor configuration

Figure 2: Package diagram of MLX90824

5. General Description

The MLX90824 is a packaged PCB-less, factory calibrated, absolute pressure sensor measuring spans from 1 to 4 bar. It delivers a digital output signal using the SENT protocol.

The MLX90824 consists of a MEMS pressure sensor element, an interface chip (CMOS technology) and passive components. The optimized solution exhibits excellent EMC performance. The DSP based signal interface provides outstanding initial accuracy. A smart package and die assembly concept enable high output stability over life, even in stringent automotive temperature and stress conditions.

MLX90824

Absolute Pressure Sensor with SENT output
Datasheet



Contents

1. Features and Benefits.....	1
2. Application Examples.....	1
3. Ordering Information.....	2
4. Package Diagram	2
5. General Description.....	2
6. Glossary of Terms	4
7. Absolute Maximum Ratings	5
8. Pin Definitions and Descriptions	6
9. General Electrical Specifications	7
10. Detailed General Description.....	8
11. Default Programmed Settings.....	9
11.1. MLX90824GXP-DAC-300	11
11.2. MLX90824GXP-DAD-301	12
11.3. MLX90824GXP-DAD-302	13
12. Digital	14
13. NTC Temperature Linearization.....	14
14. SENT Configuration.....	15
14.1. Fast Channel Configuration.....	15
14.2. Slow Channel Configuration.....	15
14.3. Diagnostics	17
14.3.1. Status Bits.....	18
14.3.2. Fast Channel Diagnostics.....	18
14.3.3. Slow Channel Diagnostics.....	18
15. Application Information.....	19
16. Storage and Handling of Plastic Encapsulated ICs.....	20
17. Assembly of Encapsulated ICs.....	20
18. Environment and Sustainability	20
19. Package Information.....	21
20. Disclaimer.....	22

MLX90824

Absolute Pressure Sensor with SENT output
Datasheet

6. Glossary of Terms

Absolute pressure: Pressure compared to internal vacuum reference
ADC: Analog to Digital Converter
Bar: Pressure unit (1bar = 100kPa)
DSP: Digital Signal Processor
EMC: Electro Magnetic Compatibility
ESD: Electrostatic discharge
FC: SENT Fast Channel
FC1: SENT Fast Channel 1
FC2: SENT Fast Channel 2
FS: Full scale, span
HTOL: High-temperature operating life
LSB: Least Significant Bits
MSN: Most significant Nibble
NTC: Negative Temperature Coefficient thermistor
OV: Over Voltage
PCB: Printed Circuit Board
PTAT: Internal temperature reference Proportional To Absolute Temperature
PTC04: Melexis Programming Tool
RV: Reverse Voltage
SCD: Slow channel diagnostic
SENT: Single Edge Nibble Transmission
SEooC: Safety Element out of Context
 T_A : Ambient temperature

MLX90824

Absolute Pressure Sensor with SENT output
Datasheet



7. Absolute Maximum Ratings

Parameter	Symbol	Value	Units	Comment
Supply Voltage (overvoltage)	OV	40	V	Max 2 hours
Reverse Voltage Protection	RV	-40	V	
Positive output voltage		40	V	
Reverse output voltage ⁽¹⁾		-40	V	
Max voltage on NTC pin		-0.2 to 2	V	Max 1 minute at Ta = 25°C
Operating Ambient Temperature Range ²	T _A	-40 to 160	°C	
Extended Operating Ambient Temperature Range		-40 to 170	°C	10 minutes continuous period, max 20 hours total duration over life
Storage Temperature Range		-40 to 160	°C	
Programming Ambient Temperature Range		-40 to 125	°C	
Proof pressure (1 bar versions)		5	Bar	DAC-300
Proof pressure (>3 bar versions)		10	Bar	DAD-301 and DAD-302
Burst pressure (1 bar versions)		6	Bar	DAC-300
Burst pressure (>3 bar versions)		16	Bar	DAD-301 and DAD-302
ESD, human body model ³		2000	V	Class 1C acc. ANSI/ESDA/JEDEC JS-001
ESD, charged device model ³		1000	V	Class C3 acc. ANSI/ESDA/JEDEC JS-002

Table 2: Absolute maximum ratings

Exceeding the absolute maximum ratings may cause permanent damage. Exposure to absolute-maximum-rated conditions for extended periods may affect device reliability.

¹ Absolute maximum DC negative output at floating supply or supply shorted to output. Maximum DC negative output at operating supply: -5.5V.

² HTOL accelerated aging test equivalent to 3680 hours at 150°C.

³ Device level performance including test pins. VDD, GND and SENT output are much more robust to account for module level ESD requirements.

MLX90824

Absolute Pressure Sensor with SENT output
Datasheet

8. Pin Definitions and Descriptions

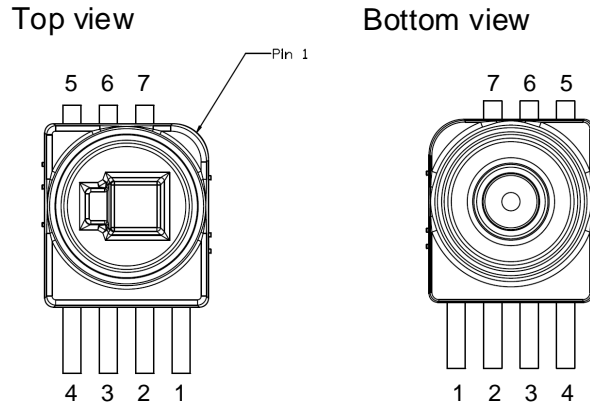

Figure 3: Package pinout

Pin number	Description
1	SENT output
2	Ground (GND)
3	Supply input (VDD)
4	NTC input
5	Test pin
6	Test pin
7	Test pin

Table 3: Pinout definitions and descriptions

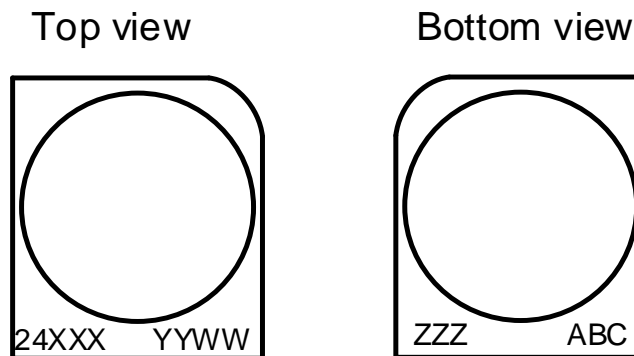

Figure 4: Package marking

Symbol	Function / Description
XXX	MEMS and ASIC traceability letter ⁽⁴⁾
ZZZ	Last three characters of lot number
ABC	Sub lot indication
YYWW	Date code

Table 4: Package marking definition

⁴ Linked to first three letters of option code.

MLX90824

Absolute Pressure Sensor with SENT output
Datasheet

9. General Electrical Specifications

DC Operating Parameters $T_A = -40^{\circ}\text{C}$ to 160°C

Parameter	Symbol	Remarks	Min	Typ ⁽⁵⁾	Max	Units
Nominal supply voltage	Vdd		4.5	5	5.5	V
Nominal supply current	Idd	Including external NTC, no additional load at the output.		10.5	12	mA
Current consumption at overvoltage	IDD_OV				20	mA
Current consumption at reverse voltage	IDD_RV				20	mA
Output short-circuit current	IOUT_SH		-20		20	mA
Resistive load on output	R _{PULL-UP}	Pull-up to Vdd at receiver ⁽⁶⁾	10		55	kOhm
Under voltage detection range		Programmable value. In default configuration set to 4.3V	4.25		4.8	V
Over voltage detection range		Programmable value. In default configuration set to 5.7V	5.2		5.75	V
Under voltage detection tolerance			-50		50	mV
Over voltage detection tolerance			-50		50	mV
Power up time		Time from reaching minimum allowed supply voltage of 4.5V till the first falling edge of the first SENT frame			5	msec
Pressure response time ⁽⁷⁾		Using default filter settings. Tick time = 3 μ s and Pause Pulse enabled.			3	SENT frames
Pressure output noise		Default configuration DAC-300, DAD-301 and DAD-302.		2	3	LSB pk-pk
Pressure output update time		SENT frame of at least 0.528ms.			1	SENT frame
Internal temperature start up time				5 +1	9 +1	ms temperature output period ⁸
Internal temperature update time				10	20	ms
Internal temperature accuracy		On chip PTAT temperature	-7.5		7.5	$^{\circ}\text{C}$
NTC temperature output noise		Default configuration DAC-300, DAD-301 and DAD-302.			4	LSB pk-pk

⁵ Typical values are defined at $T_A = +25^{\circ}\text{C}$ and $V_{DD} = 5\text{V}$.

⁶ As specified in the SENT standard.

⁷ Number of SENT frames between pressure step and 90% settled output (last frame containing stable pressure data).

⁸ The temperature output period is the time interval between two moments where temperature information is transmitted. If the internal temperature is transmitted in fast channel 2 this duration is one SENT frame. If the internal temperature is only transmitted in the slow channel this is the time between two slow channel messages with ID 23.

Parameter	Symbol	Remarks	Min	Typ ⁽⁵⁾	Max	Units
NTC start up time				10	12	ms
				+1	+1	temperature output period ⁹
NTC temperature update time				18	22	ms
NTC temperature response time		From temperature change to end of frame with output >= 90% of step size			100	ms
					+1	temperature output period
NTC temperature range	T_NTC		-50		210	°C
NTC resistance range	R_NTC		20		1M	ohm

Table 5: Electrical specifications

10. Detailed General Description

The MLX90824 consists of a pressure sensor element, a DSP-based interface chip and passive components.

The pressure sensor element consists of a diaphragm realized in the silicon chip by wafer bonding on an etched cavity with built in reference vacuum. The diaphragm reacts to a change in absolute pressure. The internal strain increases, in particular at the border of the diaphragm. Here, the piezo-resistive elements have been implanted into the silicon diaphragm forming a Wheatstone bridge, which act as a transducer.

The analog front-end of the interface chip applies filtering and converts the analog signal to a digital value. The DSP performs the compensations over temperature. Furthermore, the digital circuit provides some filtering, the possibility to linearize the pressure signal and also implements the clamping function. This chip transmits a SENT output compliant with SAE J2716 spec dated April 2016. On one of the fast channels of the SENT message it is possible to transmit linearized and calibrated temperature information measured by an external NTC thermistor. An analog interface is available for the external thermistor and the 16bits DSP performs the calibration and linearization of the measured thermistor temperature.

Extensive protection of the supply lines and output allows the MLX90824 to handle extreme overvoltage conditions and is resistant to severe external disturbances. Several diagnostic functions (over-voltage, under-voltage, overpressure, under pressure detections) have been implemented on the MLX90824 and can be enabled by programming EEPROM settings. Figure 5 shows the MLX90824 block diagram. Passive components are integrated in the package to bring excellent EMC performance without the need for additional components at module level.

⁹ The temperature output period is the time interval between two moments where temperature information is transmitted. If the NTC temperature is transmitted in fast channel 2 this duration is one SENT frame. If the NTC temperature is only transmitted in the slow channel this is the time between two slow channel messages with ID 10.

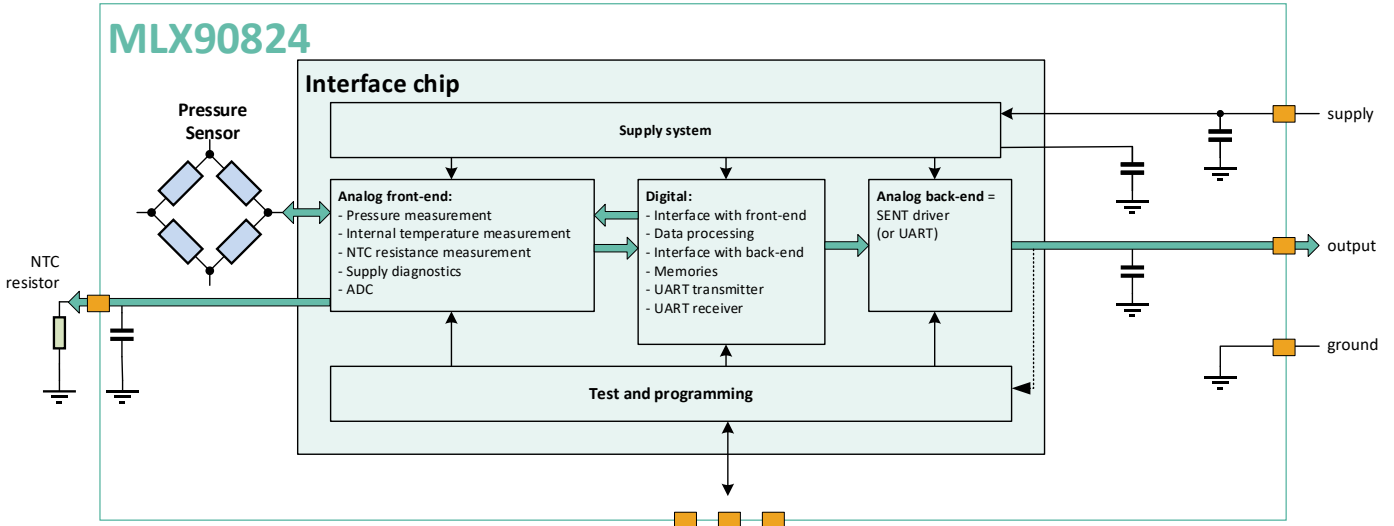

Figure 5: MLX90824 functional block diagram

11. Default Programmed Settings

The MLX90824 is calibrated at the final manufacturing test steps. During the calibration, settings are stored in the on chip EEPROM to define the pressure transfer curve. Besides pressure, the internal temperature and optionally the NTC temperature calibrations are performed. The default temperature characteristic defined by the SENT standard can be found in the graph of Figure 6. The SENT parameters and the IC filter values are also configured.

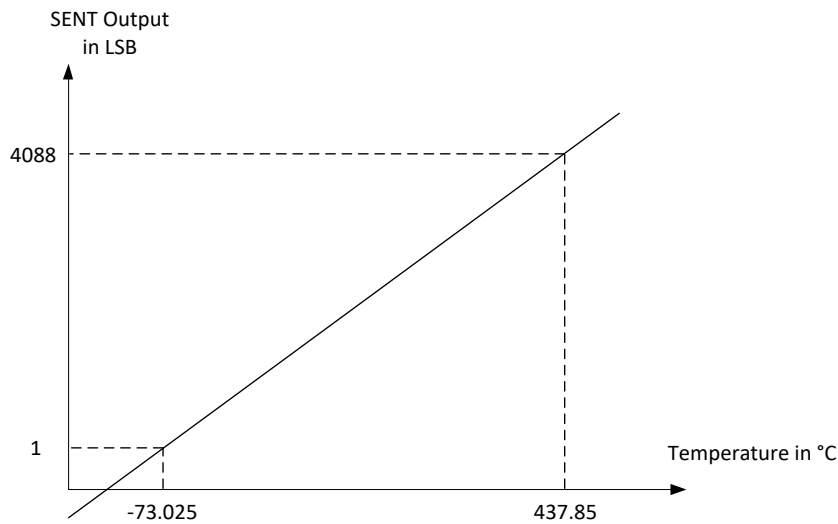

Figure 6: NTC and internal temperature transfer function

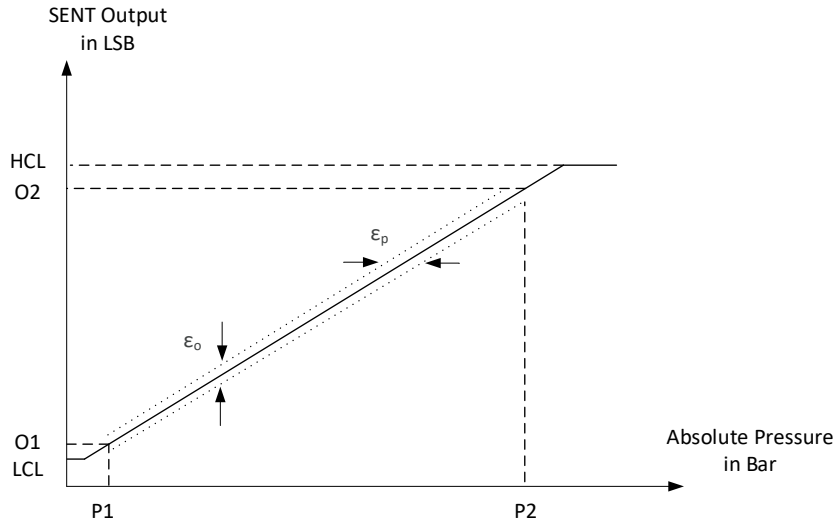

Figure 7: Pressure transfer function description

Temperature Factor
Pressure Accuracy

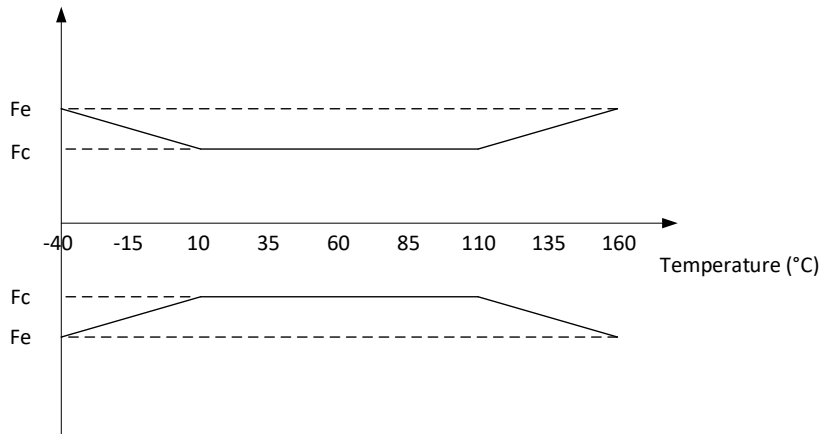

Figure 8: Pressure accuracy temperature factor

NTC temperature Accuracy (°C)

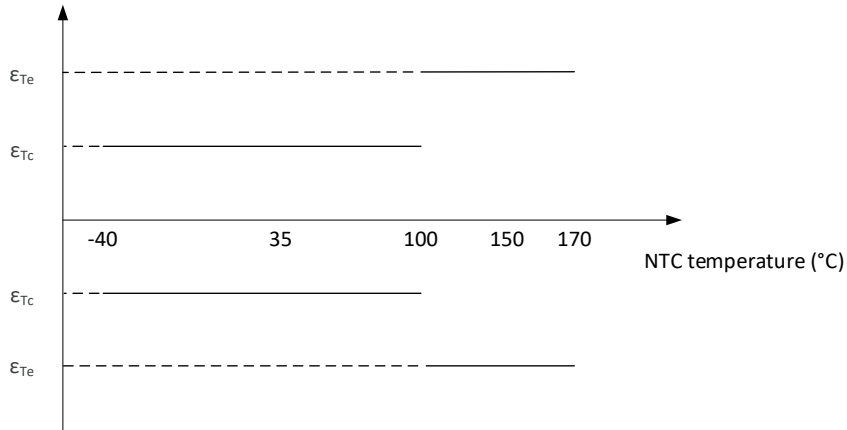

Figure 9: NTC temperature accuracy

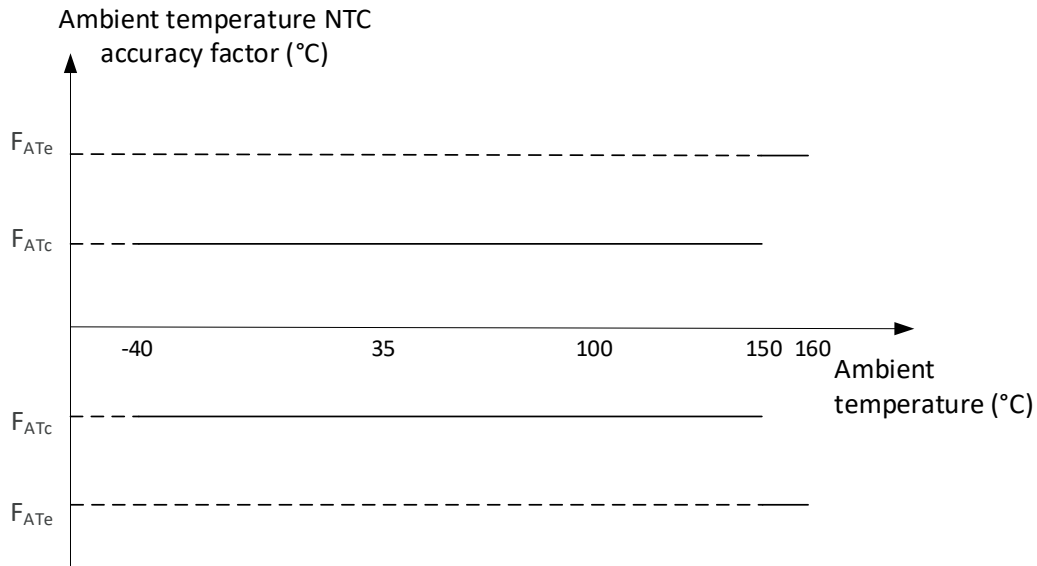

Figure 10: Ambient temperature accuracy factor on NTC

11.1. MLX90824GXP-DAC-300

Transfer Curve Parameter	Symbol	Remarks	Value			Unit
Pressure 1	P1	See Figure 7: Pressure transfer function description	0.1			Bar
Pressure 2	P2		1.15			Bar
Output 1	O1		193			LSB
Output 2	O2		3896			LSB
Low clamping level	LCL		1			LSB
High clamping level	HCL		4088			LSB
Pressure Accuracy Parameter	Symbol	Remarks	Min	Typ	Max	Unit
Output accuracy	ϵ_o	Overall accuracy expressed as output value (FS range from 193 to 3896)	-19 -0.5		19 0.5	LSB %FS
Pressure accuracy	ϵ_p	Overall accuracy expressed as pressure value	-5.25		5.25	mBar
Center temperature accuracy factor	F_c	See Figure 8: Pressure accuracy temperature factor			1	
Extended temperature accuracy factor	F_e				1.5	
NTC Accuracy Parameter	Symbol	Remarks	Min	Typ	Max	Unit
Center NTC temperature accuracy	ϵ_{Tc}	Overall accuracy using the default NTC as described in Table 9	-0.75		0.75	°C
Extended NTC temperature accuracy	ϵ_{Te}	See Figure 9: NTC temperature accuracy	-1		1	°C
Center ambient temperature factor on NTC accuracy	F_{ATc}	NTC accuracy factor related to the ambient temperature of the pressure sensor, independent of NTC temperature. See Figure 10			1	
Extended ambient temperature factor on NTC accuracy	F_{ATe}				1.5	

Table 6: DAC-300 Default configuration

MLX90824

Absolute Pressure Sensor with SENT output
Datasheet

11.2. MLX90824GXP-DAD-301

Transfer Curve Parameter	Symbol	Remarks	Value			Unit
Pressure 1	P1	See Figure 7: Pressure transfer function description	0.1			Bar
Pressure 2	P2		3			Bar
Output 1	O1		193			LSB
Output 2	O2		3896			LSB
Low clamping level	LCL		1			LSB
High clamping level	HCL		4088			LSB
Pressure Accuracy Parameter	Symbol	Remarks	Min	Typ	Max	Unit
Output accuracy	ϵ_o	Overall accuracy expressed as output value (FS range from 193 to 3896)	-19 -0.5		19 0.5	LSB %FS
Pressure accuracy	ϵ_p	Overall accuracy expressed as pressure value	-14.5		14.5	mBar
Center temperature accuracy factor	F_c	See Figure 8: Pressure accuracy temperature factor			1	
Extended temperature accuracy factor	F_e				1.25	
NTC Accuracy Parameter	Symbol	Remarks	Min	Typ	Max	Unit
Center NTC temperature accuracy	ϵ_{Tc}	Overall accuracy using the default NTC as described in Table 9	-0.75		0.75	°C
Extended NTC temperature accuracy	ϵ_{Te}	See Figure 9: NTC temperature accuracy	-1		1	°C
Center ambient temperature factor on NTC accuracy	F_{ATc}	NTC accuracy factor related to the ambient temperature of the pressure sensor, independent of NTC temperature. See Figure 10			1	
Extended ambient temperature factor on NTC accuracy	F_{ATe}				1.5	

Table 7: DAD-301 Default Configuration

MLX90824

Absolute Pressure Sensor with SENT output
Datasheet

11.3. MLX90824GXP-DAD-302

Transfer Curve Parameter	Symbol	Remarks	Value			Unit
Pressure 1	P1	See Figure 7: Pressure transfer function description	0.1			Bar
Pressure 2	P2		4			Bar
Output 1	O1		193			LSB
Output 2	O2		3896			LSB
Low clamping level	LCL		1			LSB
High clamping level	HCL		4088			LSB
Pressure Accuracy Parameter	Symbol	Remarks	Min	Typ	Max	Unit
Output accuracy	ϵ_o	Overall accuracy expressed as output value (FS range from 193 to 3896)	-19 -0.5		19 0.5	LSB %FS
Pressure accuracy	ϵ_p	Overall accuracy expressed as pressure value	-19.5		19.5	mBar
Center temperature accuracy factor	F_c	See Figure 8: Pressure accuracy temperature factor			1	
Extended temperature accuracy factor	F_e				1.25	
NTC Accuracy Parameter	Symbol	Remarks	Min	Typ	Max	Unit
Center NTC temperature accuracy	ϵ_{Tc}	Overall accuracy using the default NTC as described in Table 9	-0.75		0.75	°C
Extended NTC temperature accuracy	ϵ_{Te}	See Figure 9: NTC temperature accuracy	-1		1	°C
Center ambient temperature factor on NTC accuracy	F_{ATc}	NTC accuracy factor related to the ambient temperature of the pressure sensor, independent of NTC temperature. See Figure 10			1	
Extended ambient temperature factor on NTC accuracy	F_{ATe}				1.5	

Table 8: DAD-302 Default Configuration

12. Digital

The digital is built around a 16-bit microcontroller. It contains besides the processor also ROM, RAM and EEPROM and a set of user and system IO registers. Temperature compensation of the pressure signal and pressure linearization is handled by the microcontroller. For the pressure compensation there are EEPROM parameters allocated to be able to cover a large variety of calibration approaches.

Both for gain and offset of the pressure signal, there is a separate temperature dependency which is programmable up to a third order compensation. This is reflected in EEPROM parameters for the offset (O0, O1, O2 and O3) and for the gain (G0, G1, G2 and G3).

If required, the linearity of the pressure signal can also be compensated with a first order temperature dependency through EEPROM parameters L0 and L1.

Linearization of the NTC temperature is also covered partially by the microcontroller. More information in this topic can be found in chapter 13.

13. NTC Temperature Linearization

The default NTC characteristic which is calibrated on option codes DAC-300, DAD-301 and DAD-302 can be found in Table 9. This characteristic can be found for example in a TDK G1551 series 2.5K NTC.

T (°C)	R (Ω)	T (°C)	R (Ω)
-55	139867.5	75	455.425
-50	101912.5	80	393.35
-45	75035	85	340.975
-40	55802.5	90	296.65
-35	41900	95	258.95
-30	31750	100	226.8175
-25	24272.25	105	199.305
-20	18713.25	110	175.6725
-15	14544.75	115	155.31
-10	11393	120	137.7025
-5	8991.25	125	122.435
0	7146.5	130	109.155
5	5719.5	135	97.5725
10	4607.75	140	87.4375
15	3735.75	145	78.55
20	3047	150	70.7325
25	2500	155	63.84
30	2062.7	160	57.7475
35	1711.1	165	52.3475
40	1426.825	170	47.555
45	1195.725	175	43.2875
50	1006.9	180	39.435
55	851.8	185	36.0175
60	723.825	190	32.9725
65	617.725	195	30.2475
70	529.35	200	27.8

Table 9: Default NTC characteristic

MLX90824

Absolute Pressure Sensor with SENT output
Datasheet



When using an NTC which does not match the coefficients described below, the MLX90824 configuration can easily be updated using the PTC04 programming tool without any need of recalibration. For further support on this process please contact Melexis.

14. SENT Configuration

The SENT output is designed to be compliant with the SAE J2716 rev. Apr 2016 SENT standard. The tick time can be configured between 2.667us and 20us. 3 us tick time is configured as default for the option codes listed in this datasheet. An optional pause pulse can also be enabled to have a fixed frame length. This frame length is configurable and has a maximum of 420 ticks/SENT frame. The default configuration is 282 ticks.

14.1. Fast Channel Configuration

On the fast channel, 7 different options are available to configure channel 1 and channel 2. An overview of these different options and how to configure them can be found in Table 10.

#	FC_CFG setting	Fast Channel 1	Fast Channel 2	Remark	Default Configuration ⁽¹⁰⁾
1	0	Pressure (3x 4 bit)	NTC temperature (3x 4 bit)		DAC-300, DAD-301, DAD-302
2	1	Pressure (3x 4 bit)	Internal temperature (3x 4 bit)	PTAT (interface) temperature	
3	2	Pressure (3x 4 bit)	Reverse pressure (3x 4 bit)		
4	3	Pressure (3x 4 bit)	0 (3x 4 bit)		
5	4	Pressure (3x 4 bit)	Single secure sensor format: Rolling counter (2x 4bit) and Inverted MSN of pressure (1x 4bit)		
6	5	Pressure only (3x 4 bit)	/		
7	6	Pressure high speed (4x 3 bit)	/		

Table 10: Fast channel configuration options

14.2. Slow Channel Configuration

The Slow Serial Channel is implemented according to the Enhanced Serial Message Format using 12-bit data and 8-bit message ID as described in the SENT protocol standard SAE J2716 rev. Apr 2016.

The MLX90824 offers a large number of available slow channel messages. Some of these messages have a pre-defined ID as they are advised by the SENT standard, for example ID29-2C, ID01, ID03, ID10, ID23, ... On top of these messages which are already partially pre-defined, another 24 full configurable messages are available. Table 11 lists the available slow channel messages and which messages are enabled by default.

¹⁰ MLX90824 Option Code default configuration

MLX90824

Absolute Pressure Sensor with SENT output Datasheet



Name	ID	Description	Data	Enabled
ID_01	0x01	Diagnostic codes	Error_flags (See section 14.3.3)	Y
ID_03	0x03	Sensor Type	7	Y
ID_04	0x04	Configuration code	-	N
ID_05	0x05	Manufacturer Code	6	Y
ID_06	0x06	SENT revision	4	Y
ID_07	0x07	Fast channel 1 Characteristic X1	According to transfer curve	Y
ID_08	0x08	Fast channel 1 Characteristic X2	According to transfer curve	Y
ID_09	0x09	Fast channel 1 Characteristic Y1	193	Y
ID_0A	0x0A	Fast channel 1 Characteristic Y2	3896	Y
ID_10	0x10	NTC temperature	According to default linear temperature transfer characteristic in SAE J2716 standard	Y
ID_23	0x23	Internal temperature	According to default linear temperature transfer characteristic in SAE J2716 standard	Y
ID_29	0x29	Melexis ID1	Unique combination of IDs with traceability data	Y
ID_2A	0x2A	Melexis ID2	Unique combination of IDs with traceability data	Y
ID_2B	0x2B	Melexis ID3	Unique combination of IDs with traceability data	Y
ID_2C	0x2C	Melexis ID4	Unique combination of IDs with traceability data	Y
PR0	0xXY	Programmable ID and DATA	-	N
PR1	0xXY	Programmable ID and DATA	-	N
PR2	0x81	Programmable ID and DATA	0	Y
PR3	0x82	Programmable ID and DATA	0	Y
PR4	0xXY	Programmable ID and DATA	-	N
PR5	0xXY	Programmable ID and DATA	-	N
PR6	0xXY	Programmable ID and DATA	-	N
PR7	0xXY	Programmable ID and DATA	-	N
PR8	0x90	Programmable ID and DATA	0	Y
PR9	0x91	Programmable ID and DATA	0	Y
PR10	0x92	Programmable ID and DATA	0	Y
PR11	0x93	Programmable ID and DATA	0	Y
PR12	0x94	Programmable ID and DATA	0	Y
PR13	0x95	Programmable ID and DATA	0	Y
PR14	0x96	Programmable ID and DATA	0	Y
PR15	0x97	Programmable ID and DATA	0	Y
PR16	0xXY	Programmable ID and DATA	-	N
PR17	0xXY	Programmable ID and DATA	-	N
PR18	0xXY	Programmable ID and DATA	-	N
PR19	0xXY	Programmable ID and DATA	-	N
PR20	0xXY	Programmable ID and DATA	-	N
PR21	0xXY	Programmable ID and DATA	-	N
PR22	0xXY	Programmable ID and DATA	-	N
PR23	0xXY	Programmable ID and DATA	-	N

Table 11: Available slow channel messages

MLX90824

Absolute Pressure Sensor with SENT output Datasheet

With the PTC04 programming tool other combinations of slow channel messages can be configured. Some messages can only be enabled and disabled together in a group:

- ID_07 and ID_08
- ID_09 and ID_0A
- ID_29, ID_2A, ID_2B and ID_2C
- PR2 and PR3
- PR4 to PR7
- PR8 to PR15
- PR16 to PR23

Slow channel messages ID01, ID10 and ID23 (diagnostics, NTC temperature and internal temperature respectively) can be set to appear multiple times during the sequence of slow channel messages. Table 12 shows the options and the default configuration.

Repetition Factor Setting	Real Repetition Factor	Default
0	Message repetition disabled	ID10, ID23
1	Message repeat every 2 messages	
2	Message repeat every 3 messages	
3	Message repeat every 4 messages	
4	Message repeat every 5 messages	
5	Message repeat every 6 messages	
6	Message repeat every 7 messages	ID01
7	Message repeat every 8 messages	
8	Message repeat every 9 messages	
9	Message repeat every 10 messages	
10	Message repeat every 12 messages	
11	Message repeat every 16 messages	
12	Message repeat every 20 messages	
13	Message repeat every 24 messages	
14	Message repeat every 28 messages	
15	Message repeat every 30 messages	

Table 12: Slow channel repetition factor

14.3. Diagnostics

The MLX90824 can use the SENT output to transmit diagnostic conditions through multiple channels. The first one is by setting status bits to notify of an error happening to fast channel 1 or 2. The second option is by replacing fast channel 1 or fast channel 2 data with an error code. The last diagnostic option is by setting an error code at slow channel ID01. Each method can be configured independent from the others.

14.3.1. Status Bits

Table 13 shows the possible status bit diagnostics and which ones are enabled on status bit #0 or status bit #1 in the default configuration.

Bit	Status bit diagnostic	Default Status bit #0 triggers	Default Status bit #1 triggers
0	Fast channel 2 out of range low		
1	Fast channel 2 clamp low		✓
2	Fast channel 2 out of range high		
3	Fast channel 2 clamp high		✓
4	Fast channel 1 out of range low		
5	Fast channel 1 clamp low	✓	
6	Fast channel 1 out of range high		
7	Fast channel 1 clamp high	✓	
8	Medium temperature below lower limit		✓
9	Medium temperature above upper limit		✓
10	Supply voltage too high	✓	✓
11	Supply voltage too low	✓	✓
12	Other internal error	✓	✓
13	Internal temperature output error	✓	✓
14	NTC temperature output error		✓
15	Pressure output error	✓	

Table 13: Status bit diagnostics

14.3.2. Fast Channel Diagnostics

A diagnostic condition can replace fast channel messages with code 4090 or 4091. Both the codes and priority of diagnostic sources can be programmed separately for each channel. If two diagnostic sources trigger at the same the error code matching the higher priority diagnostic is shown on the fast channel. Table 14 shows the available diagnostic sources for the fast channels and the default configured settings.

Bit	Status bit diagnostic	Default fast channel 1	Default fast channel 2
0	Medium temperature below lower limit		
1	Medium temperature above lower limit		
2	Supply voltage too high	4091	4091
3	Supply voltage too low	4091	4091
4	Other internal error	4091	4091
5	Internal temperature output error		
6	NTC temperature output error		4090 (high prio)
7	Pressure output error	4090 (high prio)	

Table 14: Fast channel diagnostics

14.3.3. Slow Channel Diagnostics

The combination of status bits and fast channel combinations provides a quick indication whether something is wrong and whether it is a critical error. The diagnostic message ID01 in the slow channel shows specific error codes. Table 15 displays the available diagnostics flags on the slow channel and the default configuration.

SCD	Diagnostic flag	Default error code (dec)	Default error code (hex)
1	Pressure out error	3	0x003
2	NTC temp error	6	0x006
3	Internal temp	1036	0x40C
4	Internal error	2565	0xA05
5	Supply too low	32	0x020
6	Supply too high	33	0x021
7	Medium temp too high	4	0x004
8	Medium temp too low	5	0x005
9	FC1 too high	1	0x001
10	FC1 too low	2	0x002
11	FC2 too high	4	0x004
12	FC2 too low	5	0x005

Table 15: Slow channel diagnostics

15. Application Information

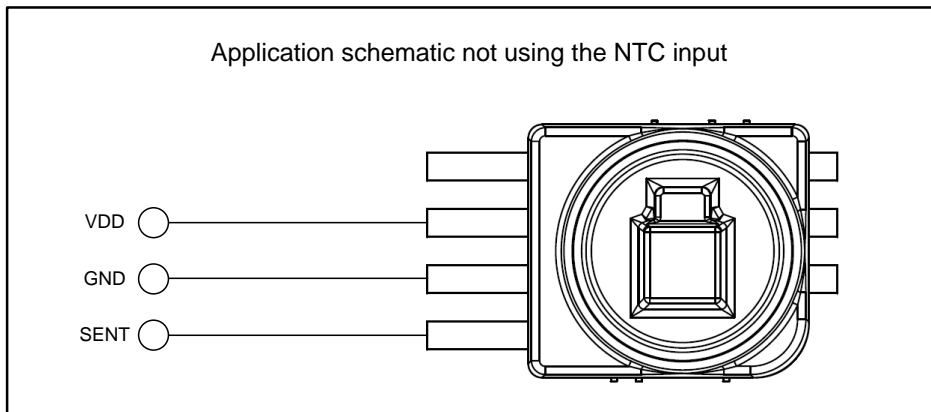

Figure 11: Basic application schematic without NTC

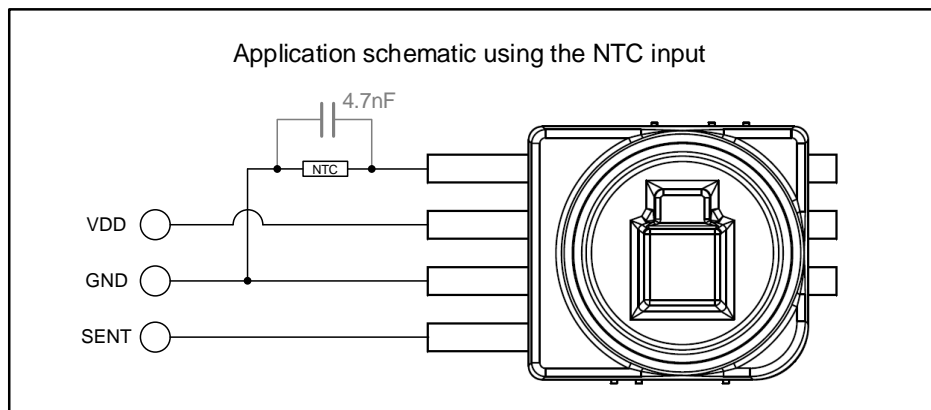

Figure 12: Basic application schematic using NTC

Figure 12 shown above represents the application schematic when using an external thermistor (NTC) connected to the NTC input put of MLX90824. In order to meet EMC requirements, it might be required to connected an external 4.7nF capacitor in parallel with the NTC in the module.

16. Storage and Handling of Plastic Encapsulated ICs

Plastic encapsulated ICs shall be stored and handled according to their MSL categorization level (specified in the packing label) as per J-STD-033.

Electronic semiconductor products are sensitive to Electro Static Discharge (ESD). The component assembly shall be handled in EPA (Electrostatic Protected Area) as per ANSI S20.20

For more information refer to Melexis [Guidelines for storage and handling of plastic encapsulated ICs](#) ⁽¹¹⁾

17. Assembly of Encapsulated ICs

For Surface Mounted Devices (SMD, as defined according to JEDEC norms), the only applicable soldering method is reflow.

For Through Hole Devices (THD), the applicable soldering methods are reflow, wave, selective wave and robot point-to-point. THD lead pre-forming (cutting and/or bending) is applicable under strict compliance with Melexis [Guidelines for lead forming of SIP Hall Sensors](#) ⁽¹¹⁾.

Melexis products soldering on PCB should be conducted according to the requirements of IPC/JEDEC and J-STD-001. Solder quality acceptance should follow the requirements of IPC-A-610.

For PCB-less assembly refer to the relevant application notes ⁽¹¹⁾ or contact Melexis.

Electrical resistance welding or laser welding can be applied to Melexis products in THD and specific PCB-less packages following the [Guidelines for welding of PCB-less devices](#) ⁽¹¹⁾.

Environmental protection of customer assembly with Melexis products for harsh media application, is applicable by means of coating, potting or overmolding considering restrictions listed in the relevant application notes ⁽¹¹⁾

For other specific process, contact Melexis via www.melexis.com/technical-inquiry

18. Environment and Sustainability

Melexis is contributing to global environmental conservation by promoting non-hazardous solutions. For more information on our environmental policy and declarations (RoHS, REACH...) visit www.melexis.com/environmental-forms-and-declarations

¹¹ www.melexis.com/ic-handling-and-assembly

19. Package Information

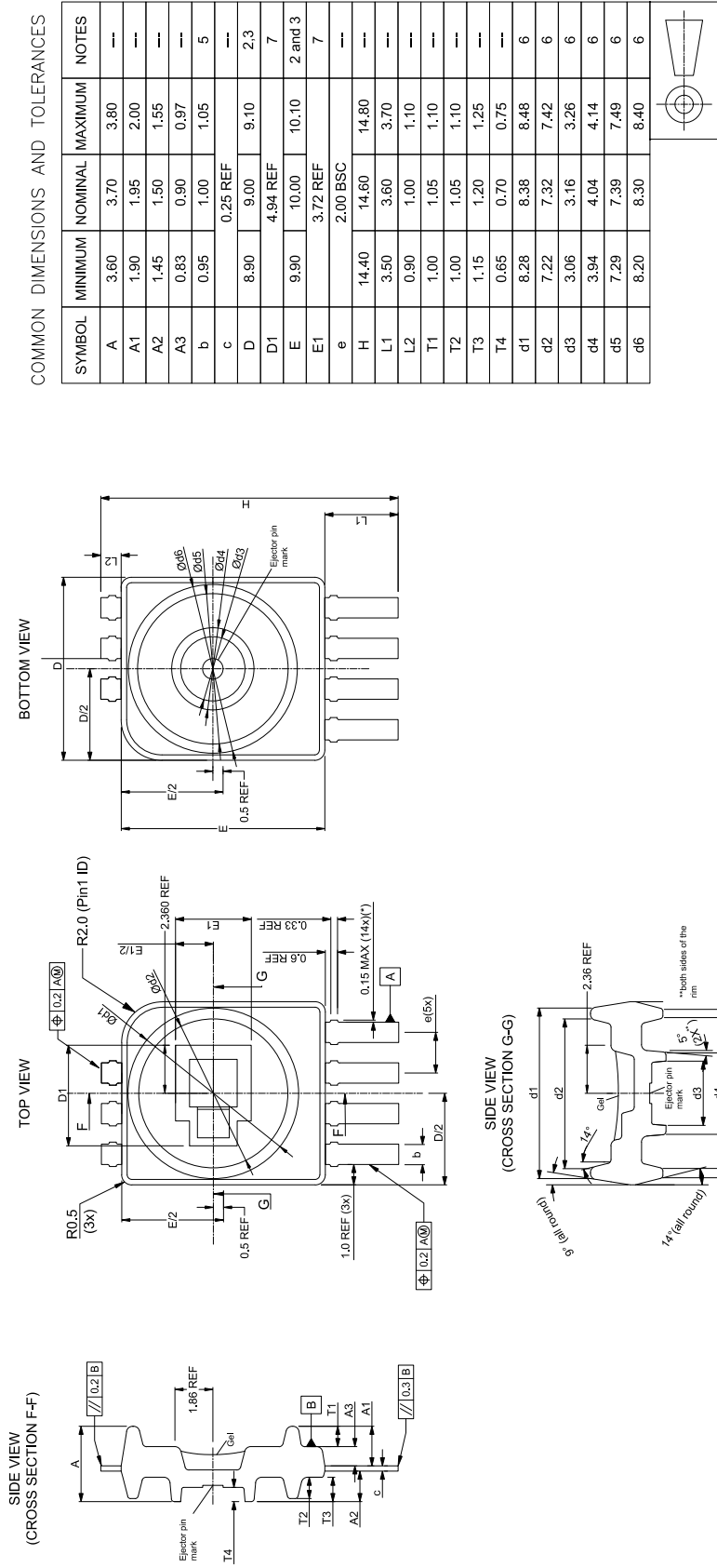

Note:

1. ALL DIMENSIONS IN MILLIMETERS (mm) UNLESS NOTED OTHERWISE.
2. PACKAGE DIMENSIONS "D", "E" AND "R2.0" DO NOT INCLUDE MOLD FLASHES, PROTRUSIONS OR GATE BURRS. CONTACT MELEXIS FOR SPECIFIC DESIGN RECOMMENDATIONS.
3. PACKAGE TOP SURFACE MAY BE SMALLER THAN PACKAGE BOTTOM.
4. SHINY SURFACE OUTLOOK DUE TO USE OF FILM.
5. DIMENSION b DOES NOT INCLUDE DAMBARY PROTRUSION.
6. MIN AND MAX VALUES DEPEND ON THE RADIUS OF THE RIM WHICH CAN VARY FROM POSITION TO POSITION.
7. DIMENSIONS "D1" AND "E1" CORRESPOND TO THE GEL FILLED CAVITY. ANY MECHANICAL CONTACT WITHIN MINIMUM DIAMETER OF "d2" SHOULD BE AVOIDED AT ALL TIME. CONTACT MELEXIS FOR SPECIFIC DESIGN RECOMMENDATIONS.

Figure 13: MLX90824 package drawing

20. Disclaimer

The content of this document is believed to be correct and accurate. However, the content of this document is furnished "as is" for informational use only and no representation, nor warranty is provided by Melexis about its accuracy, nor about the results of its implementation. Melexis assumes no responsibility or liability for any errors or inaccuracies that may appear in this document. Customer will follow the practices contained in this document under its sole responsibility. This documentation is in fact provided without warranty, term, or condition of any kind, either implied or expressed, including but not limited to warranties of merchantability, satisfactory quality, non-infringement, and fitness for purpose. Melexis, its employees and agents and its affiliates' and their employees and agents will not be responsible for any loss, however arising, from the use of, or reliance on this document. Notwithstanding the foregoing, contractual obligations expressly undertaken in writing by Melexis prevail over this disclaimer.

This document is subject to change without notice, and should not be construed as a commitment by Melexis. Therefore, before placing orders or prior to designing the product into a system, users or any third party should obtain the latest version of the relevant information.

Users or any third party must determine the suitability of the product described in this document for its application, including the level of reliability required and determine whether it is fit for a particular purpose.

This document as well as the product here described may be subject to export control regulations. Be aware that export might require a prior authorization from competent authorities. The product is not designed, authorized or warranted to be suitable in applications requiring extended temperature range and/or unusual environmental requirements. High reliability applications, such as medical life-support or life-sustaining equipment or avionics application are specifically excluded by Melexis. The product may not be used for the following applications subject to export control regulations: the development, production, processing, operation, maintenance, storage, recognition or proliferation of:

- 1. chemical, biological or nuclear weapons, or for the development, production, maintenance or storage of missiles for such weapons;*
- 2. civil firearms, including spare parts or ammunition for such arms;*
- 3. defense related products, or other material for military use or for law enforcement;*
- 4. any applications that, alone or in combination with other goods, substances or organisms could cause serious harm to persons or goods and that can be used as a means of violence in an armed conflict or any similar violent situation.*

No license nor any other right or interest is granted to any of Melexis' or third party's intellectual property rights.

If this document is marked "restricted" or with similar words, or if in any case the content of this document is to be reasonably understood as being confidential, the recipient of this document shall not communicate, nor disclose to any third party, any part of the document without Melexis' express written consent. The recipient shall take all necessary measures to apply and preserve the confidential character of the document. In particular, the recipient shall (i) hold document in confidence with at least the same degree of care by which it maintains the confidentiality of its own proprietary and confidential information, but no less than reasonable care; (ii) restrict the disclosure of the document solely to its employees for the purpose for which this document was received, on a strictly need to know basis and providing that such persons to whom the document is disclosed are bound by confidentiality terms substantially similar to those in this disclaimer; (iii) use the document only in connection with the purpose for which this document was received, and reproduce document only to the extent necessary for such purposes; (iv) not use the document for commercial purposes or to the detriment of Melexis or its customers. The confidentiality obligations set forth in this disclaimer will have indefinite duration and in any case they will be effective for no less than 10 years from the receipt of this document.

This disclaimer will be governed by and construed in accordance with Belgian law and any disputes relating to this disclaimer will be subject to the exclusive jurisdiction of the courts of Brussels, Belgium.

The invalidity or ineffectiveness of any of the provisions of this disclaimer does not affect the validity or effectiveness of the other provisions.

The previous versions of this document are repealed.

Melexis © - No part of this document may be reproduced without the prior written consent of Melexis. (2023)

IATF 16949 and ISO 14001 Certified