

HDP24-18-14PN-L017 ✓ ACTIVE

DEUTSCH | DEUTSCH HD, DEUTSCH HDP

TE Internal #: HDP24-18-14PN-L017

Housing for Male Terminals, Wire-to-Wire, 14 Position, Sealable, Black, Wire & Cable, Power & Signal, Panel Mount, -67 – 257 °F [-55 – 125 °C]

[View on TE.com >](#)



Connectors > Automotive Connectors > Automotive Housings > DEUTSCH HDP20 Housings



Connector System: **Wire-to-Wire**

Number of Positions: **14**

Connector & Housing Type: **Housing for Male Terminals**

Sealable: **Yes**

Mating Pin Diameter: **1.59 mm [.063 in]**

[All DEUTSCH HDP20 Housings \(324\)](#)

Features

Product Type Features

Mixed & Hybrid Connector	No
Connector Shape	Circular
Connector System	Wire-to-Wire
Connector & Housing Type	Housing for Male Terminals
Sealable	Yes
Connector & Contact Terminates To	Wire & Cable
Primary Locking Feature	Contact Retainer

Configuration Features

Blank Cavity Position	0
Connector Modification	Ring Adapter
Connector Seal Code	N Seal
Number of Positions	14



Electrical Characteristics

Operating Voltage	250 VAC
Nominal Voltage Architecture	12 V, 24 V, 48 V

Body Features

Cable Exit Angle	180°
Primary Product Color	Black

Contact Features

Contact Size	Size 16
Contact Type	Pin
Mating Pin Diameter	1.59 mm[.063 in]
Contact Current Rating (Max)	13 A

Mechanical Attachment

Terminal Position Assurance	No
Strain Relief	Add By Accessory
Mating Alignment Type	Guide Post
Mating Alignment	With
Connector Mounting Type	Panel Mount

Housing Features

Housing Material	PA GF
------------------	-------

Dimensions

Connector Height	41.28 mm[1.625 in]
Product Width	44.45 mm[1.75 in]
Product Length	44.75 mm[1.762 in]
Compatible Insulation Diameter Range	2.54 – 3.4 mm[.1 – .134 in]

Usage Conditions

Operating Temperature (Max)	125 °C[257 °F]
Operating Temperature Range	-55 – 125 °C[-67 – 257 °F]

Operation/Application

Circuit Application	Power & Signal
---------------------	----------------

Industry Standards

Degree of Protection	IP67
UL Flammability Rating	20mm Flame Test per Standard UL-94



Packaging Features

Packaging Method	Box
------------------	-----

Other

Serviceable	Yes
Connector Position Assurance Capable	No

Product Compliance

[For compliance documentation, visit the product page on TE.com>](#)

EU RoHS Directive 2011/65/EU	Compliant
EU ELV Directive 2000/53/EC	Compliant
China RoHS 2 Directive MIIT Order No 32, 2016	No Restricted Materials Above Threshold
EU REACH Regulation (EC) No. 1907/2006	Current ECHA Candidate List: JUNE 2023 (235) Candidate List Declared Against: JUNE 2023 (235) Does not contain REACH SVHC
Halogen Content	Not Low Halogen - contains Br or Cl > 900 ppm.
Solder Process Capability	Not reviewed for solder process capability

Product Compliance Disclaimer

This information is provided based on reasonable inquiry of our suppliers and represents our current actual knowledge based on the information they provided. This information is subject to change. The part numbers that TE has identified as EU RoHS compliant have a maximum concentration of 0.1% by weight in homogenous materials for lead, hexavalent chromium, mercury, PBB, PBDE, DBP, BBP, DEHP, DIBP, and 0.01% for cadmium, or qualify for an exemption to these limits as defined in the Annexes of Directive 2011/65/EU (RoHS2). Finished electrical and electronic equipment products will be CE marked as required by Directive 2011/65/EU. Components may not be CE marked. Additionally, the part numbers that TE has identified as EU ELV compliant have a maximum concentration of 0.1% by weight in homogenous materials for lead, hexavalent chromium, and mercury, and 0.01% for cadmium, or qualify for an exemption to these limits as defined in the Annexes of Directive 2000/53/EC (ELV). Regarding the REACH Regulation, the information TE provides on SVHC in articles for this part number is based on the latest European Chemicals Agency (ECHA) 'Guidance on requirements for substances in articles' posted at this URL: <https://echa.europa.eu/guidance-documents/guidance-on-reach>

Compatible Parts



TE Part # CAT-H396-CH8172
DEUTSCH HDP20 Housings



TE Part # CAT-H396-B128
DEUTSCH HDP20 Backshells



TE Part # CAT-D48-SP729
DEUTSCH Sealing Plugs



TE Part # HDC26-18
DUST CAP, 18SZ, REC, BLK, HDP



TE Part # CAT-D48-ST273
DEUTSCH Solid Contacts

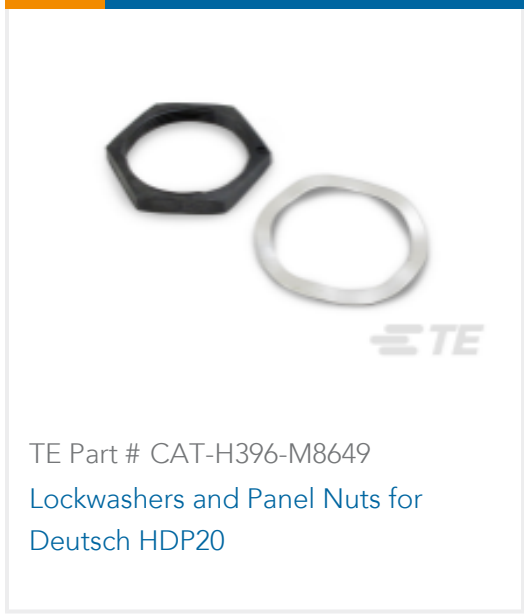

TE Part # CAT-H396-M8649
Lockwashers and Panel Nuts for
Deutsch HDP20



TE Part # CAT-J67-DSCC16
DEUTSCH Size 16 Crimp Contacts



TE Part # 18-D-PUNCH
D-HOLE PUNCH, SIZE 18



TE Part # 0411-291-1405
EXT TOOL, SIZE 16, 14-16 AWG, N,
GRN



TE Part # 0411-204-1605
EXT TOOL, SIZE 16, 16-18 AWG, N,
DRK BLU



TE Part # 2300908-1
0460-003-16329, PIN, SOLID, 20-
24AWG, AU



TE Part # 16-04978
GASKET, 18SZ, BLK, HD30

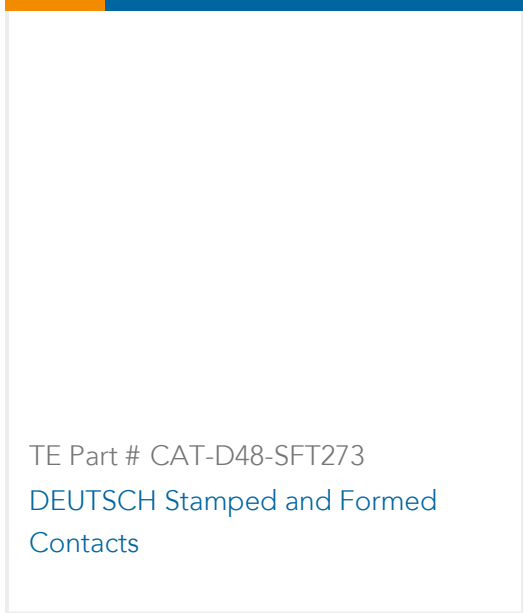

TE Part # CAT-D48-SFT273
DEUTSCH Stamped and Formed
Contacts

Also in the Series | **DEUTSCH HD**

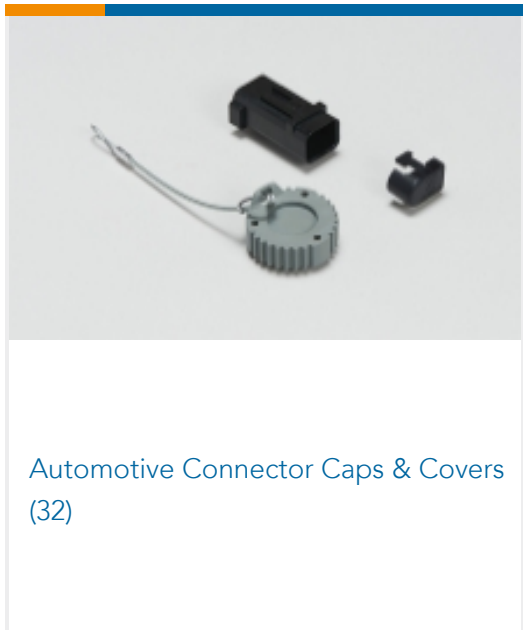

Automotive Connector Caps & Covers
(32)

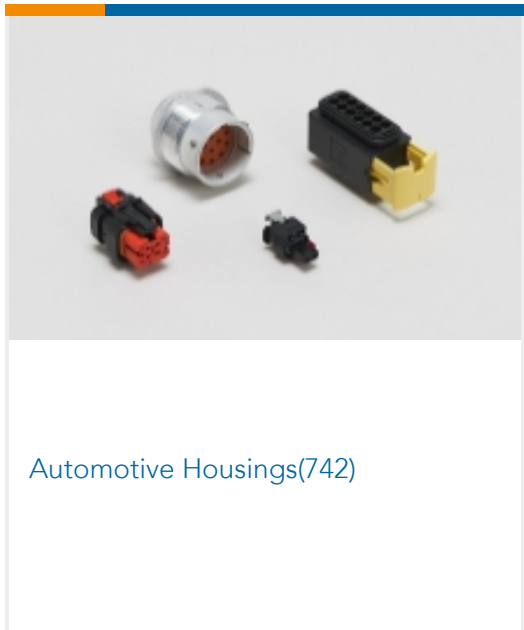

Automotive Housings(742)

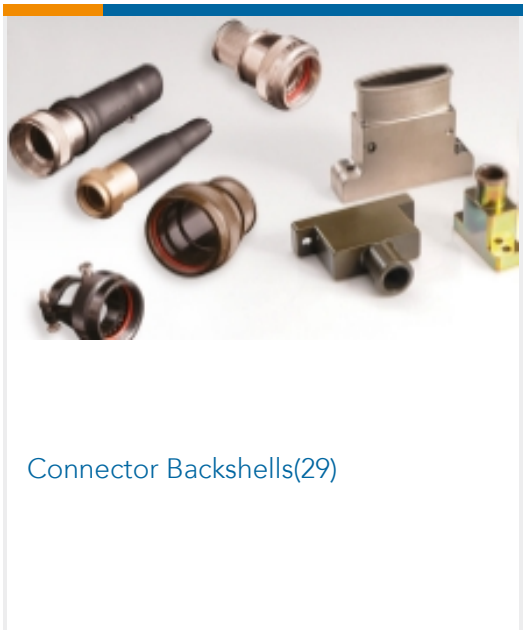

Connector Backshells(29)

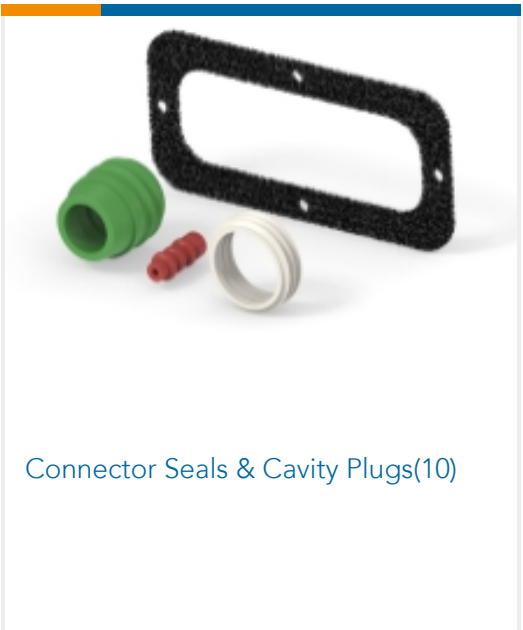

Connector Seals & Cavity Plugs(10)



Connector Strain Relief(5)



Insertion & Extraction Tools(11)



Other Automotive Connector Accessories(11)

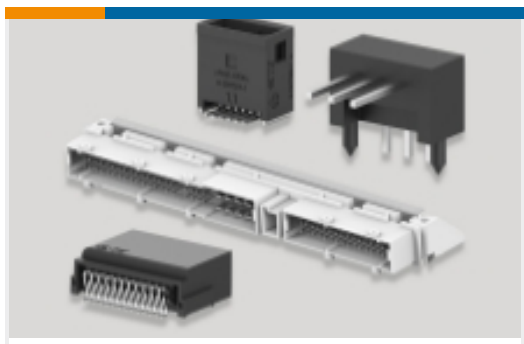

PCB Headers & Receptacles(1)

Also in the Series | DEUTSCH HDP



Automotive Connector Caps & Covers (4)



Automotive Housings(331)



Connector Backshells(8)



Connector Seals & Cavity Plugs(1)



Insertion & Extraction Tools(11)



Other Automotive Connector Accessories(5)

Customers Also Bought



TE Part #HD36-24-33SN
DEUTSCH HD30 Housings



TE Part #DRC12-24PA
REC, 24P, BLK, N, FLANGE, A



TE Part #DTP06-2S-C015
PLG, 2P, GRY, E

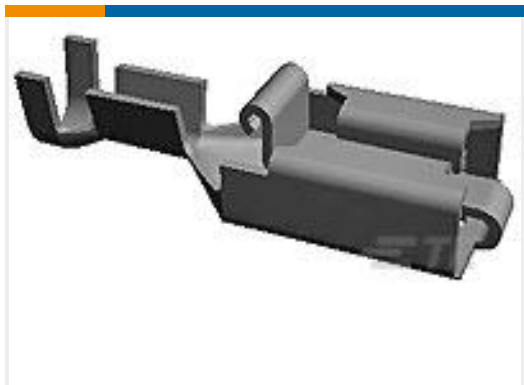

TE Part #927854-6
PL 250 REC TERMINAL 17-13 AWG
PTPB



TE Part #DRC20-50P02
HDR, 50P, BLK, ST, AU/NI/CU, 02



TE Part #HDP24-24-21PE
DEUTSCH HDP20 Housings



TE Part #K1153931
Push Button Switch TS-221-GN12 914



Documents

Product Drawings

[REC, 14P, BLK, N, RNG, 16, P](#)

English

CAD Files

[3D PDF](#)

3D

Customer View Model

[ENG_CVM_CVM_HDP24-18-14PN-L017_C.2d_dxf.zip](#)

English

Customer View Model

[ENG_CVM_CVM_HDP24-18-14PN-L017_C.3d_igs.zip](#)

English

Customer View Model

[ENG_CVM_CVM_HDP24-18-14PN-L017_C.3d_stp.zip](#)

English

By downloading the CAD file I accept and agree to the [Terms and Conditions](#) of use.

Datasheets & Catalog Pages

[CONNECTOR SELECTOR](#)

English

Product Specifications

[Application Specification](#)

English

Agency Approvals

[UL Report](#)

English