

Features

Regulated Converters

- 2W power in compact SMD package
- Operating temperature from -40°C to +85°C with no derating
- 2kVDC or 3kVDC/1minute isolation voltage
- IEC/EN 62368-1 (pending)
- UL/CSA/CAN 62368-1 certified
- Fully protected- OCP & SCP



RSH2

2 Watt
SMD DIP14
Single Output



UL62368-1 certified
CAN/CSA-C22.2 No. 62368-1 certified
IEC/EN62368-1 (pending)
EN55032 compliant

Description

High power density 2W SMD isolated DC/DC single output converters. The RSH2 is available with three different input ranges and offers single regulated output. There is no minimum load requirement. Standard isolation is 2kVDC/1min and a /H3 version with 3kVDC/1min is available. The operating temperature is from -40°C up to +85°C without derating. The DIP14 SMD pin-out is industry standard, and the converters come equipped with ON/OFF control and, short circuit protection, and over current protection, making them ideal for highly sophisticated industrial designs. The converters are fully certified to IEC/EN/UL62368 a and are 10/10 RoHS conform.

Selection Guide

Part Number	Input Voltage Range [VDC]	Output Voltage [VDC]	Output Current [mA]	Efficiency typ. ⁽¹⁾ [%]	max. Capacitive Load ⁽²⁾ [µF]
RSH2-3.33.3S ^(3,4)	2.8-5.5	3.3	500	76	1680
RSH2-3.305S ^(3,4)	2.8-5.5	5	400	78	1680
RSH2-3.312S ^(3,4)	2.8-5.5	12	167	80	820
RSH2-3.315S ^(3,4)	2.8-5.5	15	134	80	680
RSH2-3.324S ^(3,4)	2.8-5.5	24	83	80	470
RSH2-053.3S ^(3,4)	4.5-13.2	3.3	500	78	1680
RSH2-0505S ^(3,4)	4.5-13.2	5	400	81	1680
RSH2-0512S ^(3,4)	4.5-13.2	12	167	82	820
RSH2-0515S ^(3,4)	4.5-13.2	15	134	83	680
RSH2-0524S ^(3,4)	4.5-13.2	24	83	83	470
RSH2-123.3S ^(3,4)	9-18	3.3	500	79	1680
RSH2-1205S ^(3,4)	9-18	5	400	81	1680
RSH2-1212S ^(3,4)	9-18	12	167	82	820
RSH2-1215S ^(3,4)	9-18	15	134	83	680
RSH2-1224S ^(3,4)	9-18	24	83	83	470
RSH2-243.3S ^(3,4)	18-36	3.3	500	75	1680
RSH2-2405S ^(3,4)	18-36	5	400	81	1680
RSH2-2412S ^(3,4)	18-36	12	167	82	820
RSH2-2415S ^(3,4)	18-36	15	134	83	680
RSH2-2424S ^(3,4)	18-36	24	83	83	470

Notes:

Note1: Efficiency is tested at nominal input and full load at +25°C ambient

Note2: Max Cap Load is tested at minimum input and full resistive load

Model Numbering

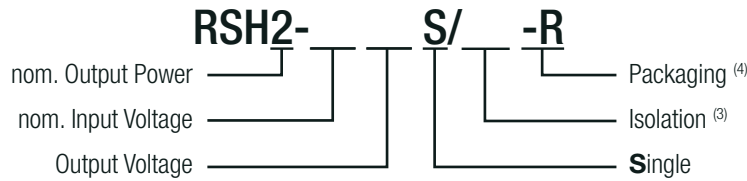

Notes:

- Note3: add suffix "/H2" for 2kVDC isolation
 add suffix "/H3" for 3kVDC isolation, for more information refer to **"Isolation Voltage (6)"**
- Note4: without suffix = standard tube packaging
 add suffix „-R“ for tape and reel packaging for more details, refer to **"PACKAGING INFORMATION"**

Ordering Examples:

RSH2-0505S/H2	4.5-13.2Vin	5Vout	single output	2kVDC/1sec isolation	tube packaging (25pcs)
RSH2-2405S/H2-R	18-36Vin	5Vout	single output	2kVDC/1sec isolation	Tape and Reel (150pcs)
RSH2-1212S/H3	9-18Vin	12Vout	single output	3kVDC/1sec isolation	tube packaging (25pcs)

Specifications (measured @ Ta= 25°C, nom. Vin, full load and after warm-up unless otherwise stated)

BASIC CHARACTERISTICS					
Parameter	Condition		Min.	Typ.	Max.
Internal Input Filter			Pi type		
Input Voltage Range	nom. Vin=	3.3VDC 5VDC 12VDC 24VDC	2.8VDC 4.5VDC 9VDC 18VDC		5.5VDC 13.2VDC 18VDC 36VDC
Input Surge Voltage (100ms max.)	nom. Vin=	3.3VDC 5VDC, 12VDC 24VDC			10VDC 25VDC 50VDC
Input Current	nom. Vin=	3.3VDC 5VDC 12VDC 24VDC		0.8A 0.5A 0.2A 0.1A	
Minimum Load			0%		
ON/OFF CTRL refer to "ON/OFF CTRL"	nom. Vin= 3.3VDC	DC-DC ON DC-DC OFF	open or high impedance external V _{CTRL} = 2.8VDC		
	nom. Vin= 5, 12VDC	DC-DC ON DC-DC OFF	open or high impedance external V _{CTRL} = 4.5VDC + 1N4148		
	nom. Vin= 24VDC	DC-DC ON DC-DC OFF	open or high impedance external V _{CTRL} = 4.5VDC + 68Ω resistor		
Internal Operating Frequency				200kHz	
Output Ripple and Noise (5)	20MHz BW				50mVp-p
Notes:					
Note5: Measurements are made with a 0.1µF MLCC across output. (low ESR)					

continued on next page

Specifications (measured @ $T_a = 25^\circ\text{C}$, nom. V_{in} , full load and after warm-up unless otherwise stated)

Efficiency vs. Load

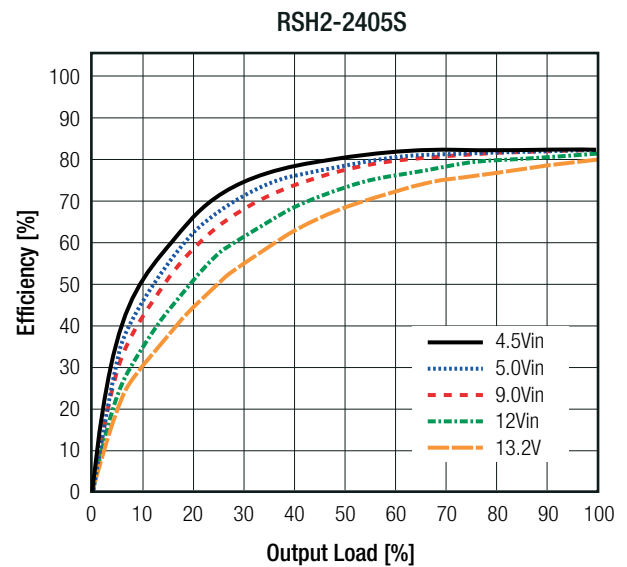
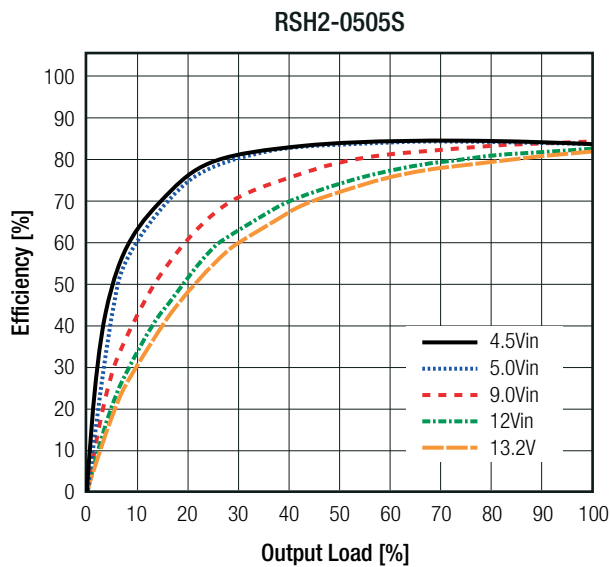
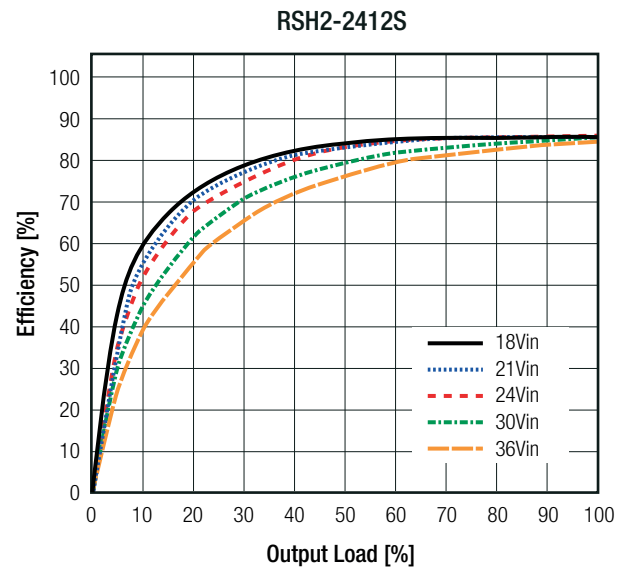
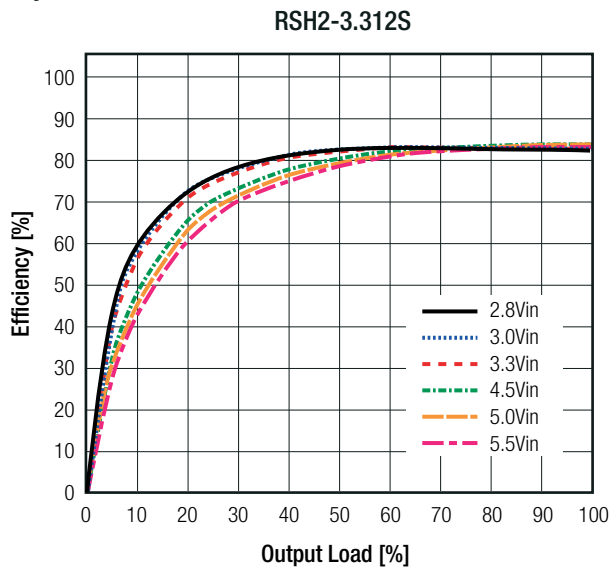

ON/OFF CTRL

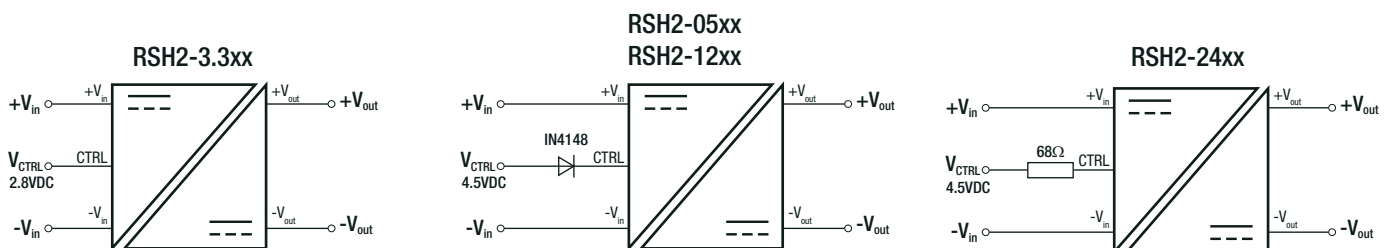

Specifications (measured @ Ta= 25°C, nom. Vin, full load and after warm-up unless otherwise stated)

REGULATIONS

Parameter	Condition	Value
Output Accuracy		±1.0% max.
Line Regulation	low line to high line, full load	±0.2% max.
Load Regulation	20% to 100% load	0.5% max.

Deviation vs. Load

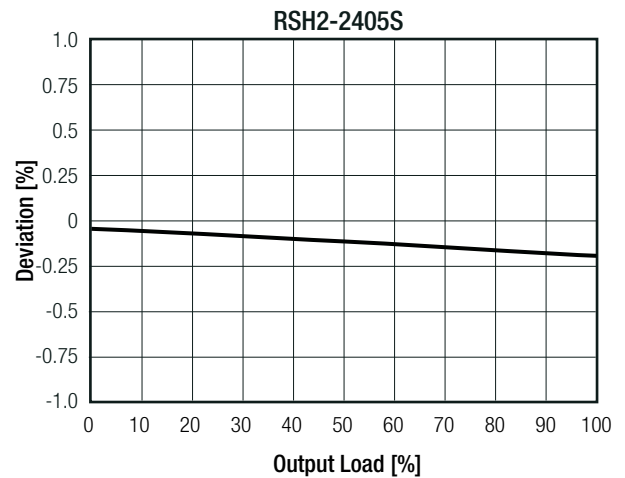
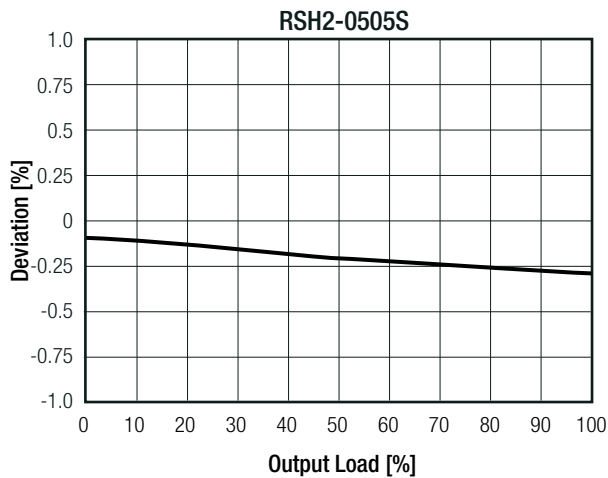
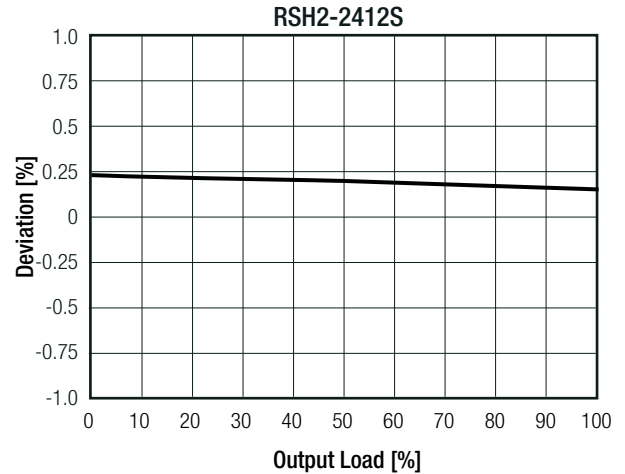
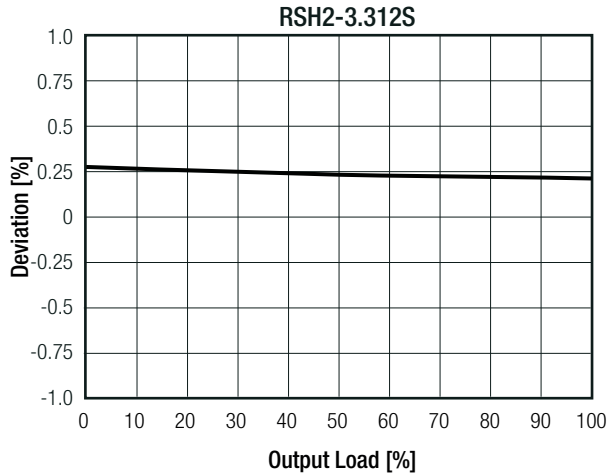

PROTECTIONS

Parameter	Type		Value
Short Circuit Protection (SCP)	below 100mΩ		continuous, auto recovery
Over Current Protection (OCP)			160% typ., hiccup mode
Isolation Voltage ⁽⁶⁾	I/P to O/P	tested for 1 minute	2kVDC 500VAC
			with suffix "H2" with suffix "H3"
Isolation Resistance			1GΩ typ.
Isolation Capacitance			50pF typ.

Notes:

Note6: For repeat Hi-Pot testing, reduce the time and/or the test voltage

Note7: Refer to local safety regulations if input over-current protection is also required. Recommended fuse: slow blow type

Specifications (measured @ Ta= 25°C, nom. Vin, full load and after warm-up unless otherwise stated)

ENVIRONMENTAL			
Parameter	Condition		Value
Operating Temperature Range	@ natural convection 0.1m/s	with derating	-40°C to +100°C
Maximum Case Temperature			105°C
Temperature Coefficient			±0.05%/K
Operating Altitude			5000m
Operating Humidity	non-condensing		95% RH max.
Pollution Degree			PD2
Vibration			MIL-STD-202G
MTBF	according to MIL-HDBK-217F, G.B.	+25°C +80°C	4140 x 10 ³ hours 1206 x 10 ³ hours

Derating Graph

(@ Chamber and natural convection 0.1 m/s)

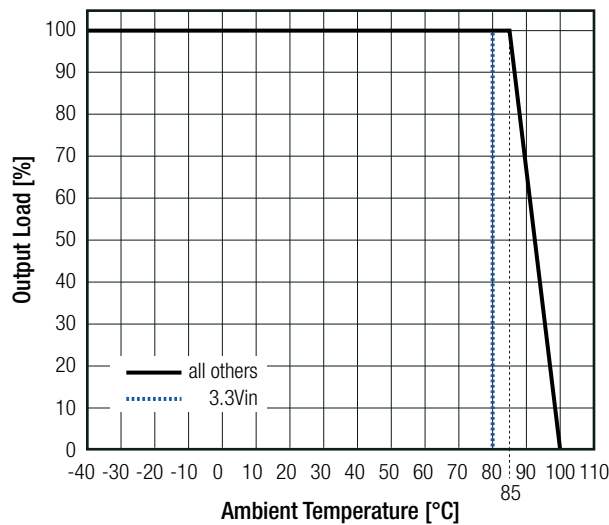

SAFETY AND CERTIFICATIONS		
Certificate Type (Safety)	File Number	Standard
Audio/Video, information and communication technology equipment - Part1: Safety requirements	E224736-A6025-UL	UL62368-1:2014 CAN/CSA-C22.2 No. 62368-1:2014
Audio/Video, information and communication technology equipment - Part1: Safety requirements	pending	IEC62368-1:2014 2nd Edition EN62368-1:2014 + A11:2017
RoHS2		RoHS 2011/65/EU + AM2015/863
EMC Compliance	Condition	Standard / Criterion
Electromagnetic compatibility of multimedia equipment - Emission requirements	with external filter refer to (" <i>EMC Filtering</i> ")	EN55032
Electromagnetic compatibility of multimedia equipment - Immunity requirements		EN55035
Information technology equipment - Immunity characteristics - Limits and methods of measurement		EN55024
ESD Electrostatic Discharge Immunity Test		IEC/EN61000-4-2
Radiated, Radio-Frequency, Electromagnetic Field Immunity Test		IEC/EN61000-4-3
Fast Transient and Burst Immunity		IEC/EN61000-4-4
Surge Immunity		IEC/EN61000-4-5
Immunity to Conducted Disturbances, Induced by Radio-Frequency Fields		IEC/EN61000-4-6

continued on next page

Specifications (measured @ Ta= 25°C, nom. Vin, full load and after warm-up unless otherwise stated)

EMC Filtering Suggestions according to EN55032 Class A/B

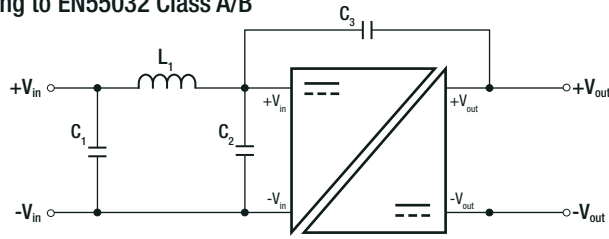

Component List Class A

MODEL	C1	C2	C3	L1
RSH2-3.312S/SMD	10µF	N/A	N/A	3.9µH
RSH2-0505S/SMD				
RSH2-2405S/SMD				
RSH2-2412S/SMD				

Component List Class B

MODEL	C1	C2	C3	L1
RSH2-3.312S/SMD	10µF	10µF	1nF	3.9µH
RSH2-0505S/SMD				
RSH2-2405S/SMD				
RSH2-2412S/SMD				

Notes:

Note8: Filter suggestions are valid for indicated part numbers only. For other part numbers, please contact RECOM tech support for advice

DIMENSION AND PHYSICAL CHARACTERISTICS

Parameter	Type	Value
Material	case & base	non-conductive black plastic
Dimension (LxWxH)		18.9 x 17.2 x 8.7mm
Weight		2.5g typ.

Dimension Drawing (mm)

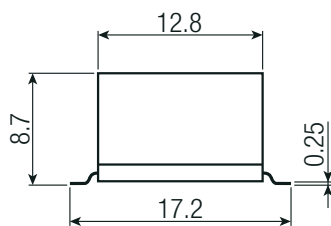
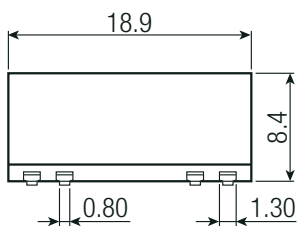
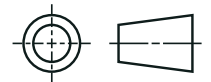
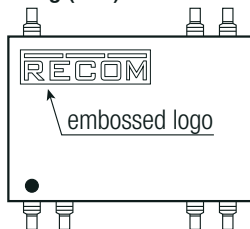

Recommended Footprint Details

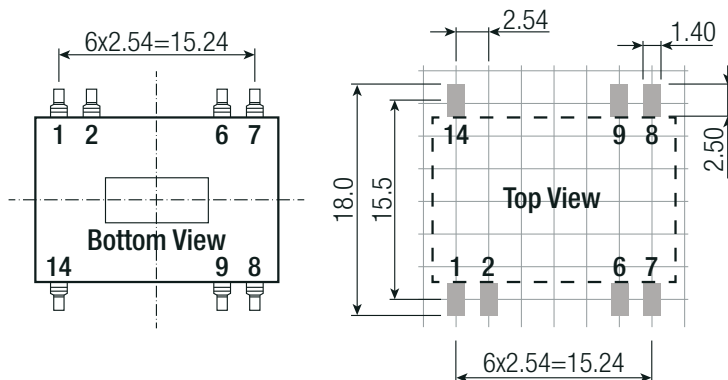

Pinning Information

Pin #	Single
1	-Vin
2	CTRL
6	NC
7	NC
8	+Vout
9	-Vout
14	+Vin

NC= no connection
 Tolerance: xx.x= ±0.5mm
 xx.xx= ±0.25mm

Specifications (measured @ Ta= 25°C, nom. Vin, full load and after warm-up unless otherwise stated)

PACKAGING INFORMATION		
Parameter	Type	Value
Packaging Dimension (LxWxH)	tube	520.0 x 22.20 x 11.80mm
	tape and reel (carton)	385.0 x 375.0 70.0mm
	reel (diameter + width)	Ø330.0 x 44.0mm
Packaging Quantity	tube	25pcs
	tape and reel	150pcs
Tape Width		44mm
Storage Temperature Range		-55°C to +125°C
Storage Humidity	non-condensing	95% RH max.

The product information and specifications may be subject to changes even without prior written notice. The product has been designed for various applications; its suitability lies in the responsibility of each customer. The products are not authorized for use in safety-critical applications without RECOM's explicit written consent. A safety-critical application is an application where a failure may reasonably be expected to endanger or cause loss of life, inflict bodily harm or damage property. The applicant shall indemnify and hold harmless RECOM, its affiliated companies and its representatives against any damage claims in connection with the unauthorized use of RECOM products in such safety-critical applications.