

2.92mm Series

# 2.92mm Coaxial Connectors MIL Standard Compliant



Millimeter Wave



COAX 2.92mm



MIL Standard



Sep. 1.2023 Copyright 2023 HIROSE ELECTRIC CO., LTD. All Rights Reserved.



## Features

---

1. 2.92mm coaxial connector conforming to MIL-STD-348B Standard

2. Supports up to 40GHz frequency

3. Board receptacle is screw-mounted

- Provides excellent high frequency performance and consistent mounting quality
- Reusable
- Reduces mounting complexity (No Soldering is required)
- Compatible with various PCB thicknesses

4. Compatible with 0.085 inch flexible cable

5. Terminator is also available.

6. RoHS2 compliant

## Applications

Data transmission measurement, radio communication equipment, measuring instruments, RF module, radio frequency power amplifier, high speed router, high speed switch, broadcasting equipment, etc.

## Product Specifications

Nominal Characteristic Impedance	50 $\Omega$	Operating Temperature	-55 to +105°C (95% RH Max.)
Rated Frequency	0 to 40GHz	Storage Temperature Range	-55 to +50°C (95% RH Max.)

Items	Specifications	Conditions
Contact Resistance	Center : 6m $\Omega$ Max. External : 2m $\Omega$ Max.	100mA Max.
Insulation Resistance	1,000M $\Omega$ Min.	100V DC
Withstanding Voltage	No breakdown	200V AC for 1 min.
V.S.W.R.*	<ul style="list-style-type: none"> <li>● HK-P-SF085</li> <li>V.S.W.R. : 1.15 Max. (0 to 18GHz)</li> <li>V.S.W.R. : 1.20 Max. (18 to 26.5GHz)</li> <li>V.S.W.R. : 1.30 Max. (26.5 to 40GHz)</li> </ul>	
	<ul style="list-style-type: none"> <li>● HK-R-SR2-SA</li> <li>V.S.W.R. : 1.5 Max. (0 to 43.5GHz)</li> </ul>	
	<ul style="list-style-type: none"> <li>● HK-LR-SR2</li> <li>V.S.W.R. : 1.30 Max. (0 to 40GHz)</li> </ul>	
Mating Durability	Contact resistance Center : 8m $\Omega$ Max. External : 4m $\Omega$ Max. No broken, cracked, or loose parts	500 times
Vibration Resistance	No electrical discontinuity of 1 $\mu$ s. No broken, cracked, or loose parts	Frequency : 10 to 500Hz, half amplitude : 0.75mm, Acceleration : 196m/s <sup>2</sup> , 10 cycles in each of the 3 axis
Shock Resistance	No electrical discontinuity of 1 $\mu$ s. No broken, cracked, or loose parts	Acceleration : 1960m/s <sup>2</sup> , duration : 6ms, Wave form : half-sine wave, 3 times in each of the 3 axis
Moisture Resistance of Temperature/Humidity Cycle	Insulation resistance : 100M $\Omega$ Min, (in a high humidity environment) Insulation resistance : 1,000M $\Omega$ Min, (in a dry environment) No broken, cracked or loose parts	Left for 10 cycles (240 hours) in an environment with the temperature ranging from -10 to +65°C and the humidity ranging from 90 to 98%.
Temperature Cycle	No broken, cracked or loose parts	5 cycles of the following test series condition : Temperature : -55°C $\rightarrow$ - $\rightarrow$ +105°C $\rightarrow$ - Time : 30 min. $\rightarrow$ 3 min. $\rightarrow$ 30 min. $\rightarrow$ 3 min.
Salt Spray	No considerable corrosion	Continuous 48 hour cycle in 5% salt water solution

(Note) Information contained in this catalog represents general requirements for this Series.  
Contact us for the drawings and specifications for a specific part number shown.

### \*V.S.W.R. (Voltage Standing Wave Ratio) Measurement System

The above V.S.W.R. specification values were measured using the measurement system shown below.

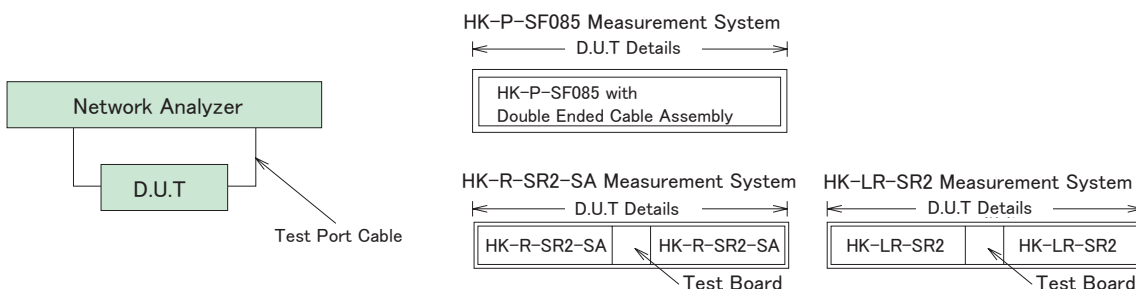

## Materials / Finish

Part	Materials	Finish
Shell	Stainless Steel / Brass	Passivated / Nickel Plating / Gold Plating
Insulator	PPO Resin / PTFE Resin / PEI Resin	—
Contact	Beryllium Copper	Gold Plated

## Product Number Structure

Refer to the chart below when determining the product specifications from the product number.  
Please select from the product numbers listed in this catalog when placing orders.

### HK - 2P - MC1 - A - 6IN

①      ②      ③      ④

① Series Name	HK	③ Applicable Cable	SF085 : 0.085-inch, Flexible Cable MC1 : 0.085-inch, Flexible Cable
② Connector Type	P : Straight Plug 2P : Double-ended Straight Plug Cable Assembly	④ Length (inch)	6, 12, 24, 36, 48, 60 inch

## ■ Receptacle

### HK - LR - SR2 (##)

①      ②      ③      ④

① Series Name	HK	③ Board Mounting Method	PCB Screw Mounting
② Connector Type	R : Vertical Mount Receptacle LR : End Launch Receptacle A : Adapter	④ Attached Screw	(00) : - (11) : 0-80UNF 1/4 inch (12) : 0-80UNF 3/16 inch (15) : 0-80UNF 1/4 + 3/16 inch

## Functional Diagram

**Plug Side**

- Straight Plug  
HK-P-SF085



**Receptacle Side**

- PCB Vertical Launch Receptacle  
HK-R-SR2-SA







  

- PCB End Launch Receptacle  
HK-LR-SR2



**Adapter**

- In-line Adapter
  - Plug — Jack  
HK-A-PJ
  - Jack — Jack  
HK-A-JJ
  - Plug — Plug  
HK-A-PP
- Conversion Adapter
  - SMP Jack — 2.92mm Jack  
SMPJ-HKJ
  - SMP Plug — 2.92mm Plug  
SMPP(FD)-HKP  
SMPP(SB)-HKP

**Terminator**

- Plug  
HK-TMP



## Plug

Please contact Hirose for assembly of cables.

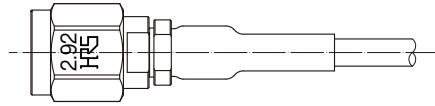

Part No.	HRS No.	Purchase Unit
HK-P-SF085	CL0338-0081-0-00	20pcs per bag

## Cable Assembly (HK Straight Plug - HK Straight Plug)

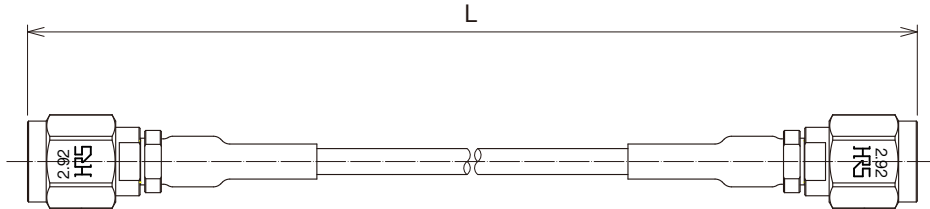
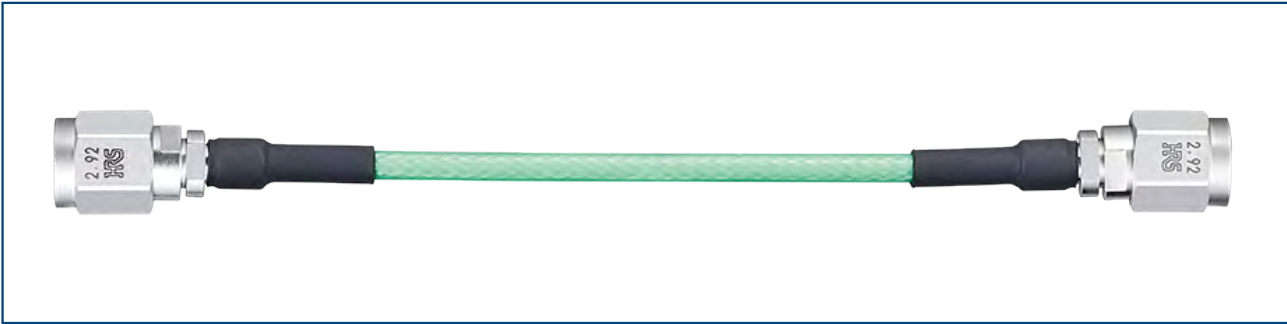

Part No.	HRS No.	Cable Assembly Length L Unit : inch	Cable Assembly Length L Unit : mm	Purchase Unit
HK-2P-MC1-A-6IN	CL0321-1934-0-05	6 ± 0.16	152.4 ± 4	20pcs per bag
HK-2P-MC1-A-12IN	CL0321-1934-0-10	12 ± 0.32	304.8 ± 8	
HK-2P-MC1-A-24IN	CL0321-1934-0-12	24 ± 0.48	609.6 ± 12	
HK-2P-MC1-A-36IN	CL0321-1934-0-13	36 ± 0.48	914.4 ± 12	
HK-2P-MC1-A-48IN	CL0321-1934-0-14	48 ± 0.71	1219.2 ± 18	
HK-2P-MC1-A-60IN	CL0321-1934-0-15	60 ± 0.87	1524.0 ± 22	

## PCB Vertical Mount Receptacle (For High Speed Transmission Evaluation Board)

This product is a solderless mounted connector for prototype evaluation of high speed transmission boards. It is not recommended for use in actual commercial equipment.

### ● Inner Layer, Back Surface, Top Surface Trace Type

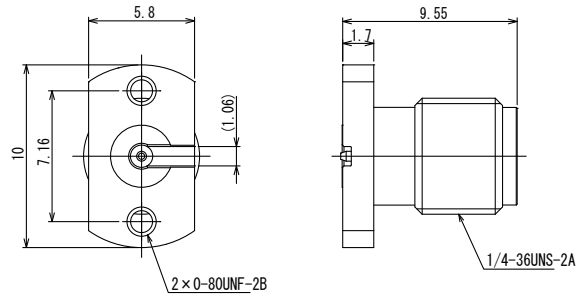

Part No.	HRS No.	Attached Screw	Purchase Unit
HK-R-SR2-SA	CL0338-0028-0-00	-	20pcs per bag
HK-R-SR2-SA(15)	CL0338-0028-0-15	0-80UNF 1/4 + 3/16 inch	

### ◆ Frequency Characteristics (TYPICAL)

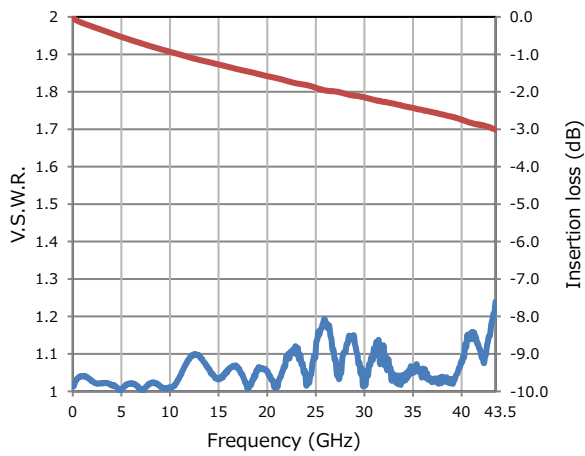

\*Coplaner line length between both connector ends : 25mm

## PCB End Launch Receptacle (For High Speed Transmission Evaluation Board)

This product is a solderless mounted connector for prototype evaluation of high speed transmission boards. It is not recommended for use in actual commercial equipment.

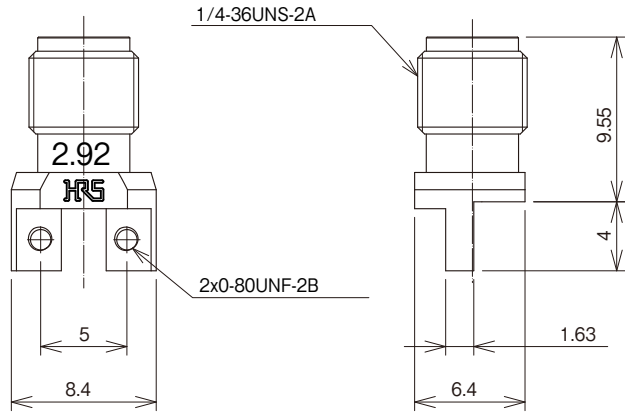

Part No.	HRS No.	Attached Screw	Purchase Unit
HK-LR-SR2	CL0338-0079-0-00	-	20pcs per bag
HK-LR-SR2(11)	CL0338-0079-0-11	0-80UNF 1/4 inch	
HK-LR-SR2(12)	CL0338-0079-0-12	0-80UNF 3/16 inch	

### ◆ Frequency Characteristics (TYPICAL)

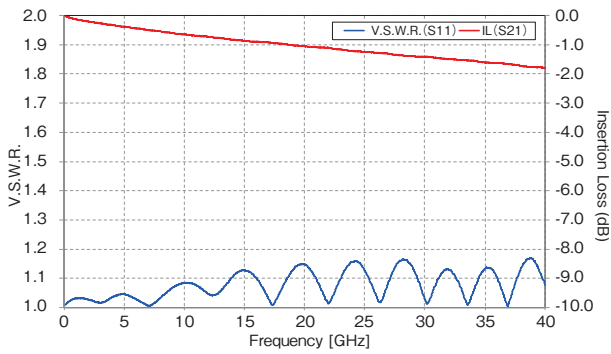

\*Coplaner line length between both connector ends : 20mm



## In-line Adapter

### ● Straight Adapter

Mated Portion: Plug – Jack

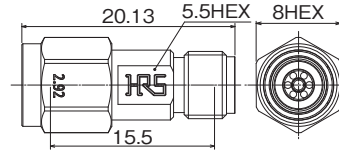

Part No.	HRS No.	Purchase Unit
HK-A-PJ	CL0338-0097-0-00	20pcs per bag

### Mated Portion: Jack – Jack

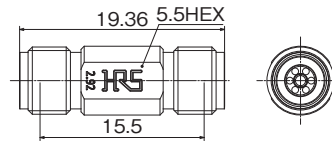

Part No.	HRS No.	Purchase Unit
HK-A-JJ	CL0338-0098-0-00	20pcs per bag

### Mated Portion: Plug – Plug

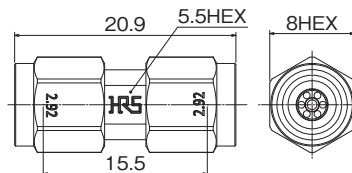

Part No.	HRS No.	Purchase Unit
HK-A-PP	CL0338-0099-0-00	20pcs per bag

### V.S.W.R. (Max.) (All in-line adapters have the same value.)

0 to 18GHz	18 to 26.5GHz	26.5 to 40GHz
1.1	1.15	1.2

## Conversion Adapter

### SMP Jack – 2.92mm Jack (0 to 40GHz)

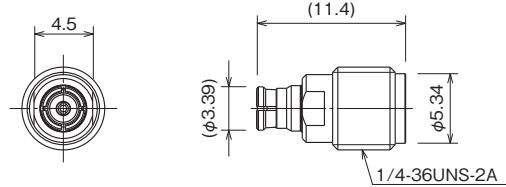

Part No.	HRS No.	Purchase Unit
SMPJ-HKJ	CL0311-0013-0-00	20pcs per bag

### SMP Plug – 2.92mm Plug (0 to 40GHz)

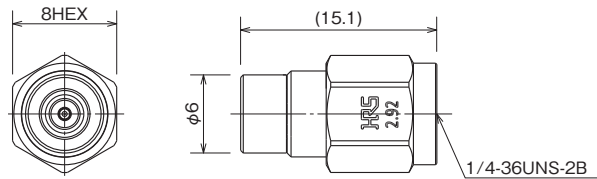

Part No.	HRS No.	Purchase Unit
SMPP(FD)-HKP	CL0311-0199-0-00	20pcs per bag
SMPP(SB)-HKP	CL0311-1001-0-00	

Note : Insertion / Extraction Force  
 FD : FULL DETENT  
 SB : SMOOTH BORE

### V.S.W.R. (Max.) (All conversion adapters have the same value.)

0 to 10GHz	10 to 30GHz	30 to 40GHz
1.15	1.25	1.38

## Precautions

1. The diameter of the center contact pin is only  $\phi 0.92\text{mm}$ .  
Please handle with care. When mating the component with the corresponding connector, rotate the hex part only.
2. If any dust is found on the shell interface when mating the components, please wipe with alcohol.

## While Taking into Consideration

Specifications mentioned in this catalog are reference values.

When considering to order or use this product, please review the Drawing and Product Specifications sheets.

Use an appropriate cable when using the connector in combination with cables.

If considering usage of a non-specified cable, please contact your sales representative.

If assembly process is done by jigs & tools which are not identified by Hirose, the warranty of the product may be affected.

If considering usage for below mentioned applications, please contact your sales representative.

In cases where the application will demand a high level of reliability, such as automotive, medical instruments, public infrastructure, aerospace/defense etc. Hirose must review before assurance of reliability can be given.

**HIROSE****HIROSE ELECTRIC CO.,LTD.**2-6-3 Nakagawa Chuoh, Tsuzuki-Ku, Yokohama-Shi 224-8540, JAPAN  
<https://www.hirose.com>

2.92mm-TM Series

2.92mm Coaxial Connectors

MIL Standard Compliant/Non-reflective Terminator

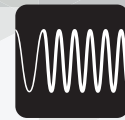

Millimeter Wave



COAX 2.92mm

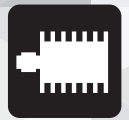

Terminator



Sep. 1. 2023 Copyright 2023 HIROSE ELECTRIC CO., LTD. All Rights Reserved.



## Features

1. Non-reflective Terminator Supporting 0 to 40GHz
2. Small Size, Light Weight
3. Low V.S.W.R.& High Reliability
4. MIL Compliant (MIL-STD-348B) 2.92mm Coaxial Terminator

## Applications

Optical transmission devices, data transmission measurement, radio communication equipment, measuring instruments, other high frequency devices, etc.

## Product Specifications

Nominal Characteristic Impedance	50 Ω	Operating Temperature	-40 to +85°C
Rated Frequency	0 to 40GHz	Operating Relative Humidity	95% RH Max.
Power	0.5W CW (+75°C )		

## Materials / Finish

Part	Materials	Finish
Shell	Stainless Steel	Passivate
Insulator	PTFE Resin	-
Male Contact	Brass	Gold Plated
Coupling	Stainless Steel	Passivate
Resistive Element	Metal Film	-

## Product Number Structure

### HK - TM P

- ①      ②      ③

① Series Name	HK	③ Connector Type	P : Plug Type
② TM	Non-reflective Terminator		

## Terminator

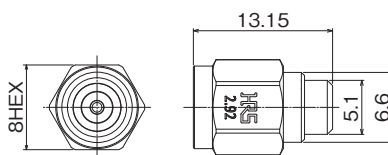

Part No.	HRS No.	Purchase Unit
HK-TMP	CL0353-0014-0-00	1pc per bag

### V.S.W.R. (Max.)

0 to 10GHz	10 to 20GHz	20 to 35GHz	35 to 40GHz
1.1	1.15	1.18	1.28

### ◆Frequency Characteristics (TYPICAL)

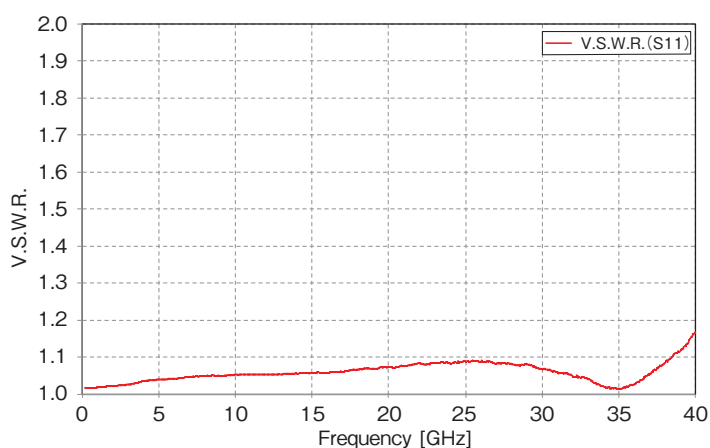

## Precautions

1. The diameter of the center contact pin is only  $\phi 0.92\text{mm}$ .  
Please handle with care. When mating the component with the corresponding connector, rotate the hex part only.
2. If any dust is found on the shell interface when mating the components, please wipe with alcohol.

## While Taking into Consideration

Specifications mentioned in this catalog are reference values.

When considering to order or use this product, please review the Drawing and Product Specifications sheets.

Use an appropriate cable when using the connector in combination with cables.

If considering usage of a non-specified cable, please contact your sales representative.

If assembly process is done by jigs & tools which are not identified by Hirose, the warranty of the product may be affected.

If considering usage for below mentioned applications, please contact your sales representative.

In cases where the application will demand a high level of reliability, such as automotive, medical instruments, public infrastructure, aerospace/defense etc. Hirose must review before assurance of reliability can be given.