

HDSP-311x, HDSP-313x

10.16-mm (0.4-in.) Single-Digit General-Purpose Seven-Segment Display



AV02-3585EN Description

This Broadcom® 10.16-mm (0.4-in.) LED single-digit seven-segment display uses industry-standard size package and pinout. The device is available in either common anode or common cathode. The choice of colors includes AllnGaP Red, AllnGaP Green, AllnGaP Deep Red, and AllnGaP Yellow. The gray face displays are suitable for indoor use.

Applications

- Suitable for indoor use
- Not recommended for industrial applications, that is, operating temperature requirements exceeding +85° C or below -25° C (see note)
- Extreme temperature cycling not recommended

NOTE: For additional details, contact your local Broadcom sales office or an authorized distributor.

Features

- Industry-standard size
- Industry-standard pinout
 - 10.16-mm (0.4-in.) character height
 - DIP lead on 2.54 mm
- Choice of colors
 - AllnGaP Red, AllnGaP Green, AllnGaP Deep Red, and AllnGaP Yellow
- Excellent appearance
 - Evenly lighted segments gray package gives optimum contrast
 - ± 50 ft. viewing angle
- Design flexibility
 - Common anode right hand decimal point or common cathode right hand decimal point
- Categorized for luminous intensity
 - Green and yellow categorized for color

Devices

AllnGaP Red	AllnGaP Green	AllnGaP Deep Red	AllnGaP Yellow	Description	Package Drawing
HDSP-311E	HDSP-311G	HDSP-311A	HDSP-311Y	Common Anode Right Hand Decimal	A
HDSP-313E	HDSP-313G	HDSP-313A	HDSP-313Y	Common Cathode Right Hand Decimal	B

Package Dimensions

Package Drawing A

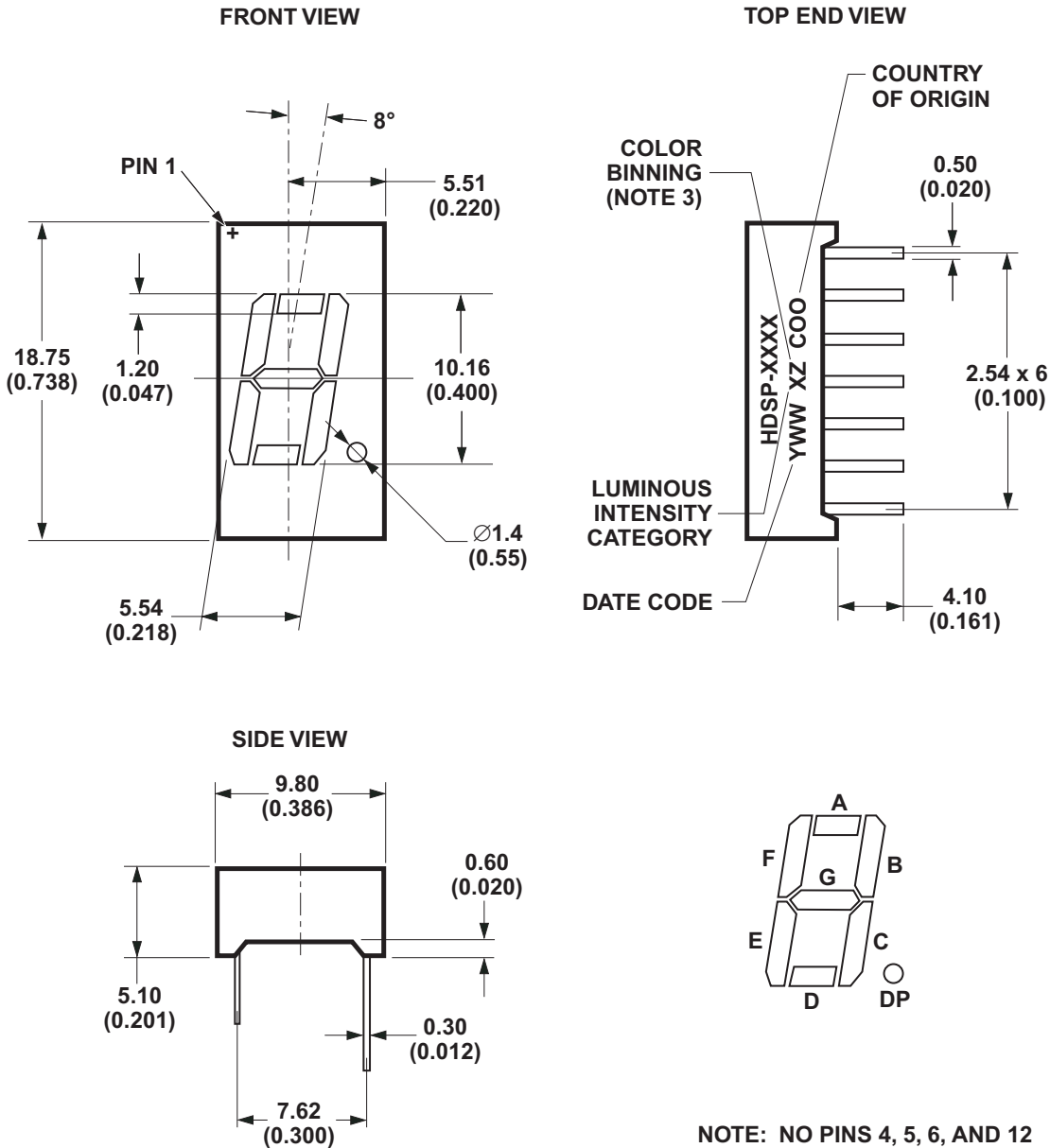

NOTE: NO PINS 4, 5, 6, AND 12

NOTE:

1. All dimensions are in millimeters (inches).
2. Tolerance is 0.25 mm (0.01 in.) unless otherwise stated.
3. For yellow and green series product only.

Package Drawing B

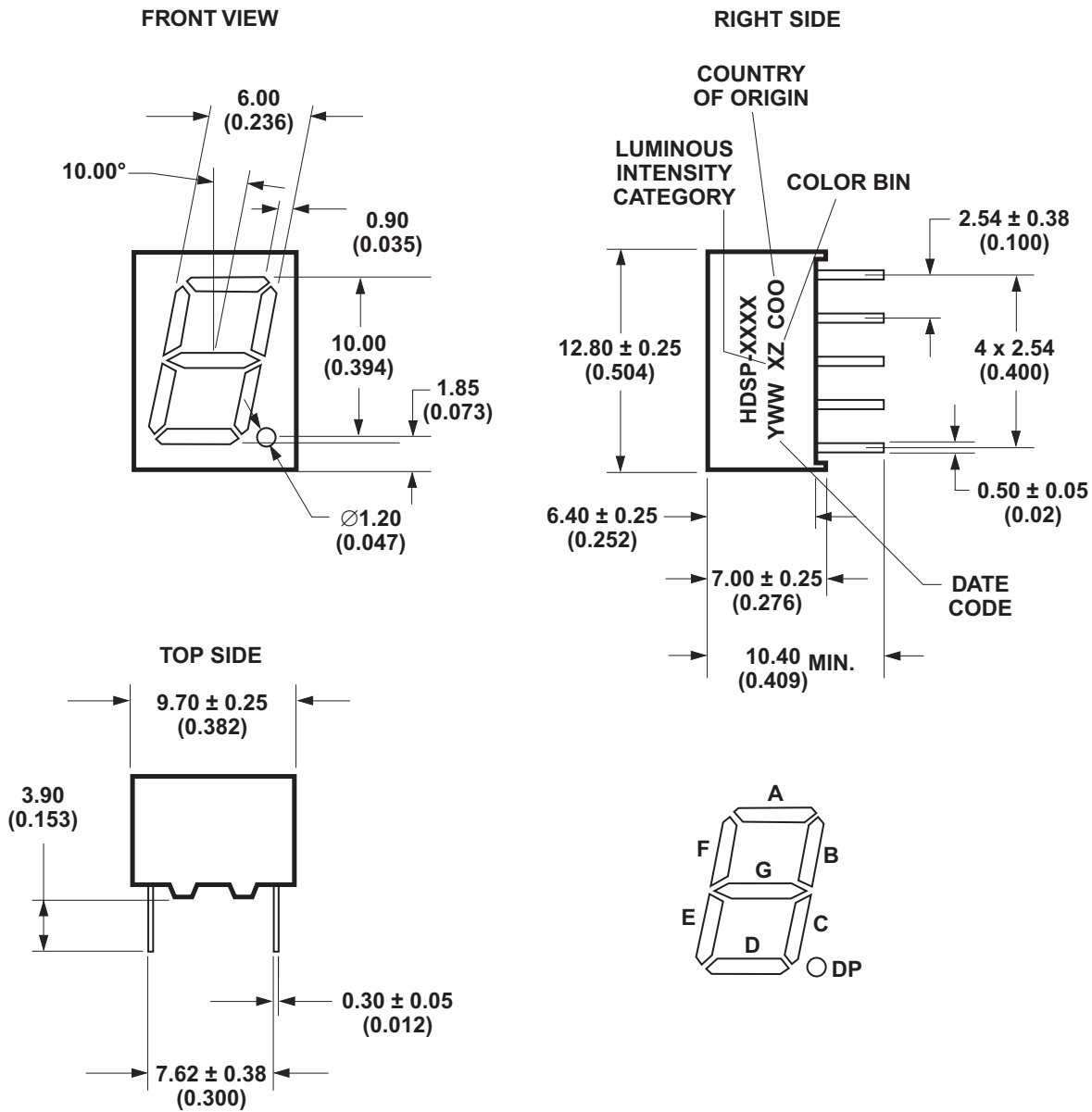

NOTE:

1. All dimensions are in millimeters (inches).
2. Tolerance is 0.25 mm (0.01 in.) unless otherwise stated.
3. For yellow and green series product only.

Internal Circuit Diagram

Common Anode Right-Hand Decimal

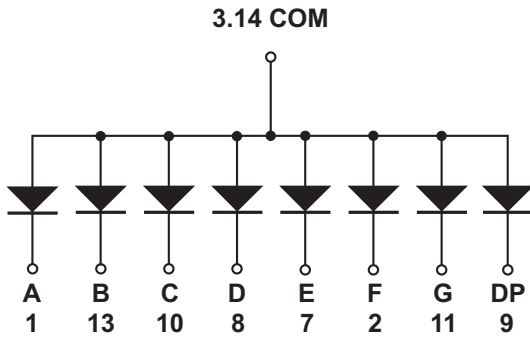

HDSP-311E/311G/311Y/311A

PIN No.	CONNECTION
1	CATHODE A
2	CATHODE F
3	COMMON ANODE
7	CATHODE E
8	CATHODE D
9	CATHODE DP
10	CATHODE C
11	CATHODE G
13	CATHODE B
14	COMMON ANODE
PINS 4, 5, 6, 12: NO PIN	

Common Cathode Right-Hand Decimal

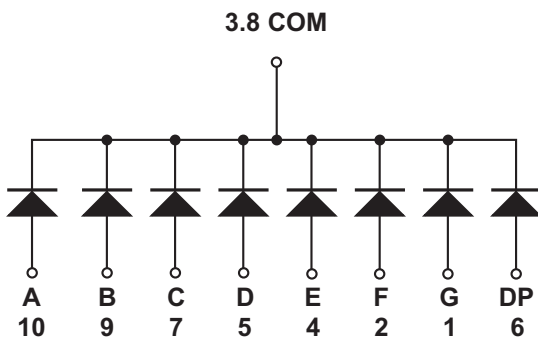

HDSP-313E/313G/313Y/313A

PIN NO.	CONNECTION
1	ANODE G
2	ANODE F
3	COMMON CATHODE
4	ANODE E
5	ANODE D
6	ANODE DP
7	ANODE C
8	COMMON CATHODE
9	ANODE B
10	ANODE A

Absolute Maximum Ratings at $T_A = 25^\circ\text{C}$

Description	Red HDSP-31xE	Green HDSP-31xG	Deep Red HDSP-31xA	Yellow HDSP-31xY	Units
Power Dissipation Segment	62.5	62.5	52	50	mW
Forward Current Segment	25 ^a	25 ^b	20 ^c	20 ^d	mA
Peak Forward Current per Segment ^e	90	90	60	60	mA
Operating Temperature Range	-40 to +85	-40 to +85	-40 to +85	-40 to +85	°C
Storage Temperature Range	-40 to +85	-40 to +85	-40 to +85	-40 to +85	°C
Reverse Voltage per Segment or DP ^f	5	5	5	5	V
Wavesoldering Temperature for 3 Seconds (at 2-mm distance from the body)	250	250	250	250	°C

- Derate linearly as shown in [Figure 4](#).
- Derate linearly as shown in [Figure 8](#).
- Derate linearly as shown in [Figure 12](#).
- Derate linearly as shown in [Figure 16](#).
- Duty factor = 10%, frequency = 1 kHz, $T_A = 25^\circ\text{C}$.
- Reverse Voltage is for LED testing purposes and is not recommended to be used as an application condition.

Electrical/Optical Characteristics at $T_A = 25^\circ\text{C}$

Device HDSP-	Parameter	Symbol	Min.	Typ.	Max.	Units	Test Conditions
Red							
311E 313E	Luminous Intensity/Segment ^{a, b, c}	I_V	2.00	3.60	—	mcd	$I_F = 10\text{ mA}$
	Forward Voltage ^d	V_F	—	1.95	2.50	V	$I_F = 20\text{ mA}$
	Peak Wavelength	λ_P	—	633	—	nm	
	Dominant Wavelength ^e	λ_d	—	622	—	nm	
	Reverse Voltage ^f	V_R	5	—	—	V	$I_R = 100\ \mu\text{A}$
Green							
311G 313G	Luminous Intensity/Segment ^{a, b, c}	I_V	3.20	5.90	—	mcd	$I_F = 10\text{ mA}$
	Forward Voltage ^d	V_F	1.80	2.10	2.50	V	$I_F = 20\text{ mA}$
	Peak Wavelength	λ_P	—	572	—	nm	
	Dominant Wavelength ^e	λ_d	—	570	—	nm	
	Reverse Voltage ^f	V_R	5	—	—	V	$I_R = 100\ \mu\text{A}$
Deep Red							
311A 313A	Luminous Intensity/Segment ^{a, b, c}	I_V	3.20	7.50	—		$I_F = 10\text{ mA}$
	Forward Voltage ^d	V_F	—	2.00	2.60	V	$I_F = 20\text{ mA}$
	Peak Wavelength	λ_P	—	660	—	nm	
	Dominant Wavelength ^e	λ_d	—	640	—	nm	
	Reverse Voltage ^f	V_R	5	—	—	V	$I_R = 100\ \mu\text{A}$

Device HDSP-	Parameter	Symbol	Min.	Typ.	Max.	Units	Test Conditions
Yellow							
311Y	Luminous Intensity/Segment ^{a, b, c}	I_V	1.25	1.90	—		$I_F = 10 \text{ mA}$
313Y	Forward Voltage ^d	V_F	—	2.10	2.50	V	$I_F = 20 \text{ mA}$
	Peak Wavelength	λ_P	—	592	—	nm	
	Dominant Wavelength ^e	λ_d	—	588	—	nm	
	Reverse Voltage ^f	V_R	5	—	—	V	$I_R = 100 \mu\text{A}$

- a. The luminous intensity, I_V , is measured at the mechanical axis of the package.
- b. The optical axis is closely aligned with the mechanical axis of the package.
- c. Tolerance is $\pm 15\%$.
- d. Forward voltage tolerance is $\pm 0.1\text{V}$.
- e. The dominant wavelength, λ_d , is derived from the CIE Chromaticity Diagram and represents the perceived color of the device.
- f. Indicates product final test condition. Long term reverse bias is not recommended.

Intensity Bin Limits (mcd at 10 mA)

Red

IV Bin Category	Min.	Max.
I	2.001	3.200
J	3.201	5.050
K	5.051	8.000

Tolerance for each bin limit is $\pm 15\%$.

Green/Deep Red

IV Bin Category	Min.	Max.
J	3.201	5.050
K	5.051	8.000
L	8.001	12.650

Tolerance for each bin limit is $\pm 15\%$.

Yellow

IV Bin Category	Min.	Max.
H	1.251	2.000
I	2.001	3.200
J	3.201	5.050

Tolerance for each bin limit is $\pm 15\%$.

Color Bin Limits (nm at 10 mA)

Color	Bin	Dominant Wavelength (nm)	
		Min.	Max.
Green	3	569.1	571.1
	4	571.1	573.1
	5	573.1	585.5
Yellow	1	585.5	588.5
	2	588.5	591.5
	3	591.5	594.5

Tolerance for each bin limit is 1 nm.

Red

Figure 1: Relative Intensity vs. Wavelength

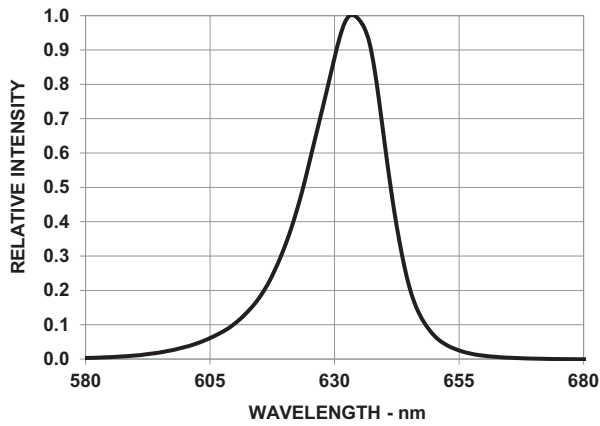

Figure 2: Forward Current vs. Forward Voltage

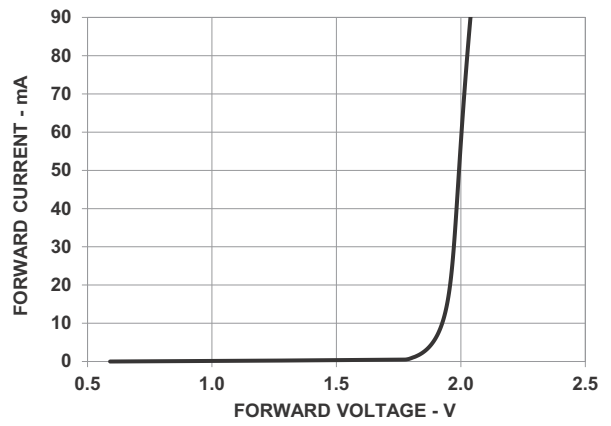

Figure 3: Relative Luminous Intensity vs. Forward Current

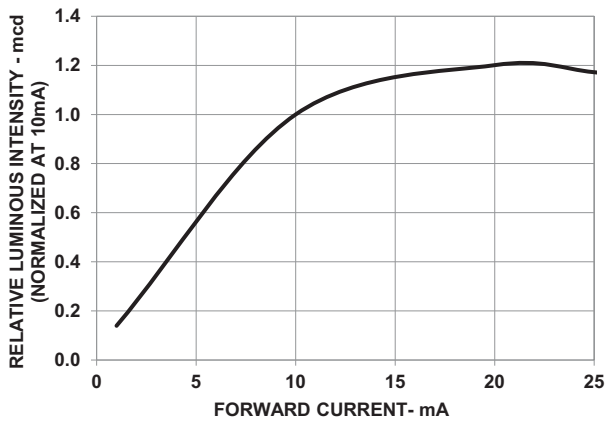
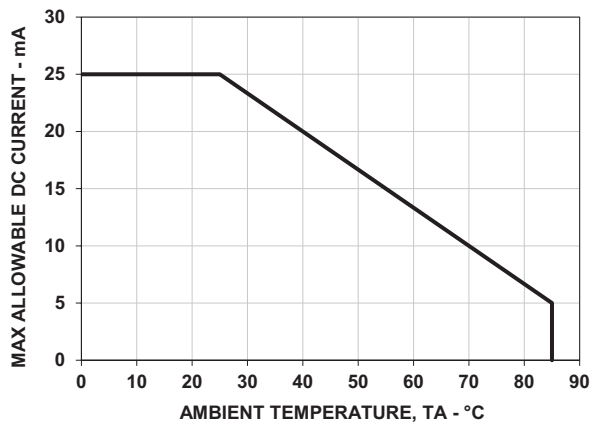

Figure 4: Maximum Forward Current vs. Ambient Temperature



Green

Figure 5: Relative Intensity vs. Wavelength

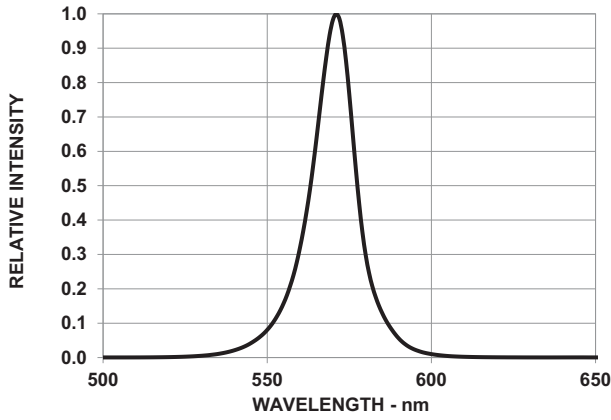

Figure 6: Forward Current vs. Forward Voltage

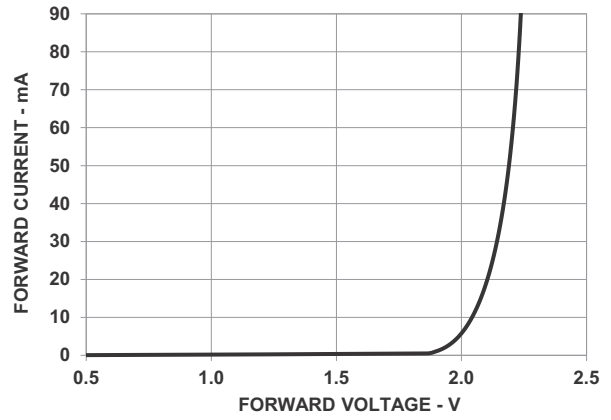

Figure 7: Relative Luminous Intensity vs. Forward Current

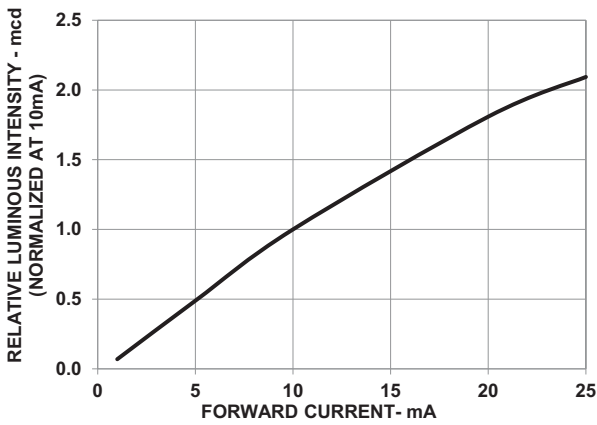
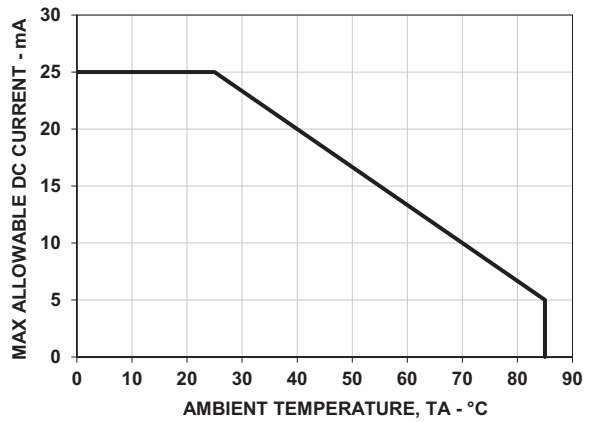

Figure 8: Maximum Forward Current vs. Ambient Temperature



Deep Red

Figure 9: Relative Intensity vs. Wavelength

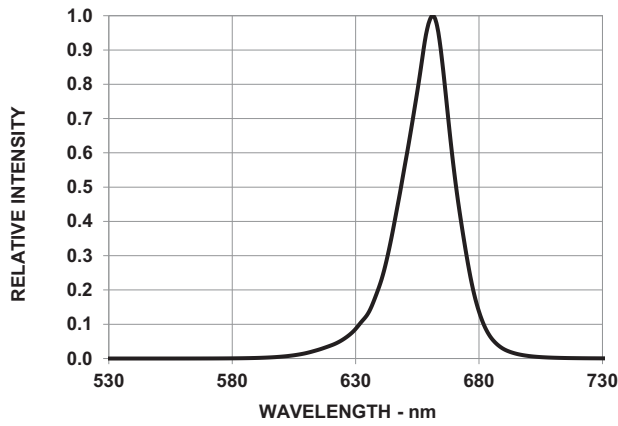

Figure 10: Forward Current vs. Forward Voltage

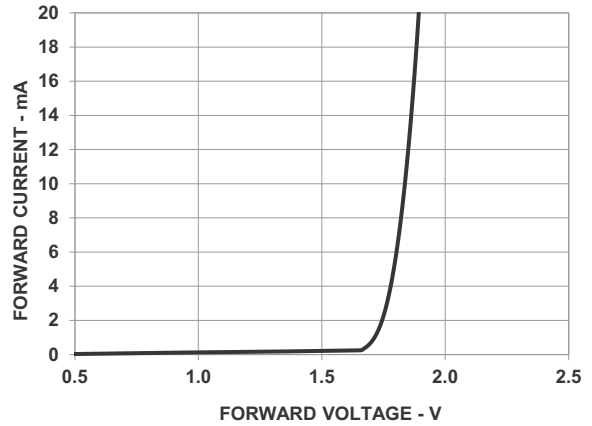

Figure 11: Relative Luminous Intensity vs. Forward Current

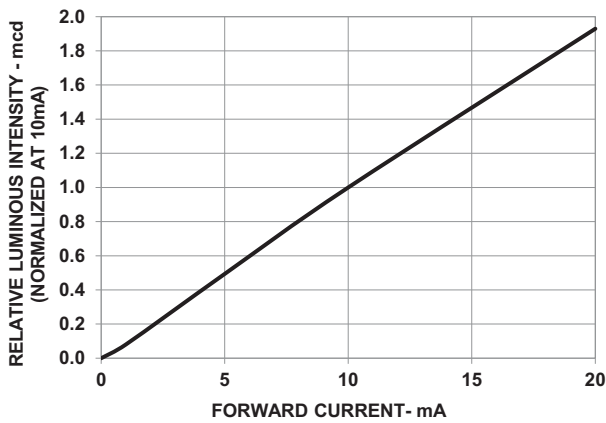
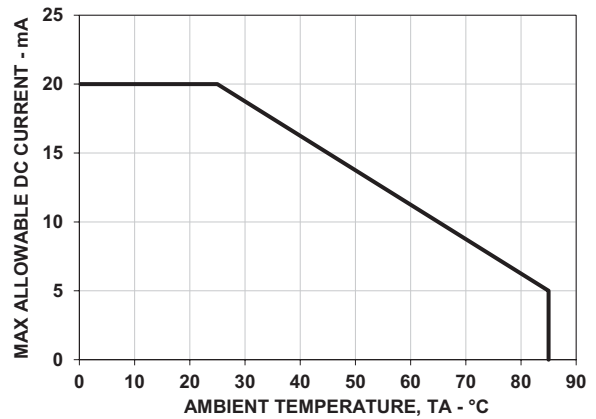

Figure 12: Maximum Forward Current vs. Ambient Temperature



Yellow

Figure 13: Relative Intensity vs. Wavelength

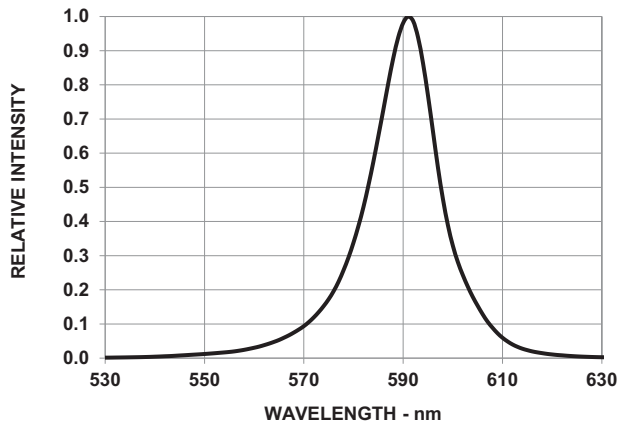

Figure 14: Forward Current vs. Forward Voltage

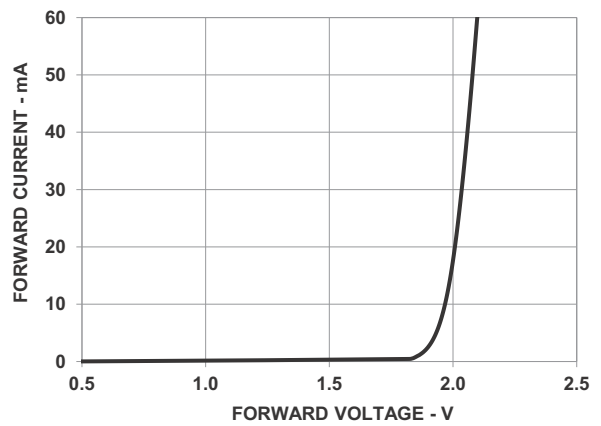

Figure 15: Relative Luminous Intensity vs. Forward Current

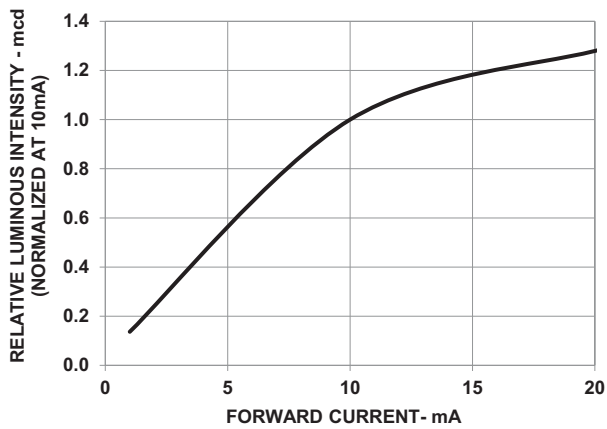
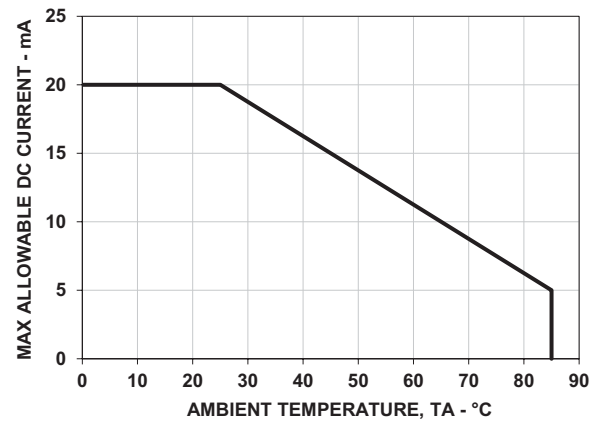

Figure 16: Maximum Forward Current vs. Ambient Temperature



Precautionary Notes

Soldering and Handling Precautions

- Set and maintain the wave soldering parameters according to the recommended temperature and dwell time. Perform daily checks on the profile to ensure that it conforms to the recommended conditions. Exceeding these conditions will over-stress the LEDs and cause premature failures.
- Use only bottom preheaters to reduce thermal stress experienced by the LEDs.
- Recalibrate the soldering profile before loading a new type of PCB. A PCB with different size and design (component density) will have different heat capacity and might cause a change in temperature experienced by the PCB if the same wave soldering setting is used.
- Do not perform wave soldering more than once.
- Loosely fit any alignment fixture used during wave soldering and do not apply stress on the LEDs. Use non-metal material because it absorbs less heat during the wave soldering process.
- At elevated temperatures, the LEDs are more susceptible to mechanical stress. Allow the PCB to be sufficiently cooled to room temperature before handling. Do not apply stress to the LED when it is hot.
- Use wave soldering to solder the LED. Use hand soldering only for rework or touch up if unavoidable, but it must be strictly controlled to following conditions:
 - Soldering iron tip temperature = 315°C maximum
 - Soldering duration = 2 seconds maximum
 - Number of cycles = 1 only
 - Power of soldering iron = 50W maximum
- For ESD sensitive devices, apply proper ESD precautions at the soldering station. Use only an ESD-safe soldering iron.
- Do not touch the LED package body with the soldering iron except for the soldering terminals because it may cause damage to the LED.
- Confirm beforehand whether the functionality and performance of the LED are affected by soldering with hand soldering.
- Keep the heat source at least 1.6 mm away from the LED body during soldering.
- Design an appropriate hole size to avoid problems during insertion.
- Do not use cleaning agents from the ketone family (acetone, methyl ethylketone, and so on) and from the chlorinated hydrocarbon family (methylene chloride, trichloroethylene, carbon tetrachloride, and so on) to

clean the LED displays. All of these solvents attack or dissolve the encapsulating epoxies used to form the package of plastic LED parts.

- For the purposes of cleaning, wash with DI water only. Perform the cleaning process at room temperature only. Clear any water or moisture from the LED display immediately after washing.
- Use *No clean* solder paste for soldering.

Figure 17: Recommended Wave Soldering Profile

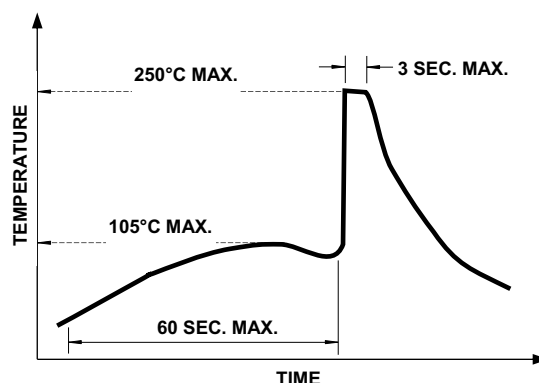

NOTE: The measurements are performed with a thermocouple mounted at the bottom of the PCB.

Application Precautions

- The drive current of the LED must not exceed the maximum allowable limit across temperature as stated in the data sheet. Use constant current driving to ensure consistent performance.
- The circuit design must cater to the entire range of forward voltage (V_F) of the LEDs to ensure the intended drive current can always be achieved.
- The LED exhibits slightly different characteristics at different drive currents, which may result in a larger variation of performance (such as intensity, wavelength, and forward voltage). Set the application current as close as possible to the test current to minimize these variations.
- The LED is not intended for reverse bias. Use other appropriate components for such purposes. When driving the LED in matrix form, ensure that the reverse bias voltage does not exceed the allowable limit of the LED.

- Avoid rapid changes in ambient temperature, especially in high-humidity environments, because they cause condensation on the LED.
- If the LED is intended to be used in a harsh or an outdoor environment, protect the LED against damages caused by rain, water, dust, oil, corrosive gases, external mechanical stresses, and so on.

Eye Safety Precautions

LEDs may pose optical hazards when in operation. Do not look directly at operating LEDs because it might be harmful to the eyes. For safety reasons, use appropriate shielding or personal protective equipment.

Disclaimer

Broadcom's products and software are not specifically designed, manufactured, or authorized for sale as parts, components, or assemblies for the planning, construction, maintenance, or direct operation of a nuclear facility or for use in medical devices or applications. The customer is solely responsible, and waives all rights to make claims against Broadcom or its suppliers, for all loss, damage, expense, or liability in connection with such use.

Copyright © 2012–2022 Broadcom. All Rights Reserved. The term “Broadcom” refers to Broadcom Inc. and/or its subsidiaries. For more information, go to www.broadcom.com. All trademarks, trade names, service marks, and logos referenced herein belong to their respective companies.

Broadcom reserves the right to make changes without further notice to any products or data herein to improve reliability, function, or design. Information furnished by Broadcom is believed to be accurate and reliable. However, Broadcom does not assume any liability arising out of the application or use of this information, nor the application or use of any product or circuit described herein, neither does it convey any license under its patent rights nor the rights of others.



Lead (Pb) Free
RoHS Compliant