

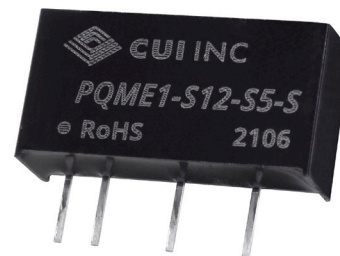

SERIES: PQME1-S | **DESCRIPTION:** DC-DC CONVERTER

FEATURES

- 1 W isolated output
- single regulated output
- 1.5k Vdc isolation
- short circuit protection
- wide operating temperature range -40~85°C
- efficiency up to 75%
- designed to meet EN/BS EN 62368-1



MODEL	input voltage		output voltage	output current		output power	ripple & noise ¹	efficiency ²
	typ (Vdc)	range (Vdc)	(Vdc)	min (mA)	max (mA)	max (W)	max (mVp-p)	typ (%)
PQME1-S12-S5-S	12	11.4~12.6	5	20	200	1.0	100	73
PQME1-S12-S9-S	12	11.4~12.6	9	12	111	1.0	100	73
PQME1-S12-S12-S	12	11.4~12.6	12	9	83	1.0	100	73
PQME1-S12-S15-S	12	11.4~12.6	15	7	67	1.0	150	75
PQME1-S15-S5-S	15	14.25~15.75	5	20	200	1.0	100	73
PQME1-S15-S15-S	15	14.25~15.75	15	7	67	1.0	150	75
PQME1-S24-S3-S	24	22.8~25.2	3.3	25	250	0.83	100	71
PQME1-S24-S5-S	24	22.8~25.2	5	20	200	1.0	100	73
PQME1-S24-S9-S	24	22.8~25.2	9	12	111	1.0	100	73
PQME1-S24-S12-S	24	22.8~25.2	12	9	83	1.0	100	73
PQME1-S24-S15-S	24	22.8~25.2	15	7	67	1.0	100	73

Notes: 1. Measured at nominal input, 20 MHz bandwidth oscilloscope.
 2. Measured at nominal input voltage, full load.
 3. All specifications are measured at Ta=25°C, humidity < 75%, nominal input voltage, and rated output load unless otherwise specified.

PART NUMBER KEY

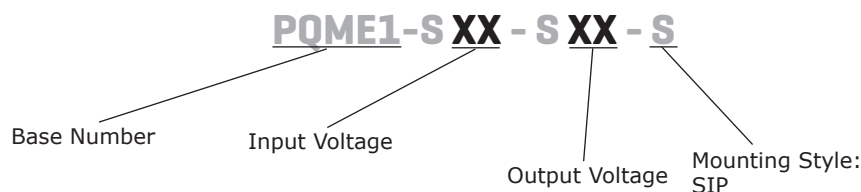

INPUT

parameter	conditions/description	min	typ	max	units
input voltage	12 Vdc input models	11.4	12	12.6	Vdc
	15 Vdc output models	14.25	15	15.75	Vdc
	24 Vdc output models	22.8	24	25.2	Vdc
current	12 Vdc input models:			121	mA
	5, 9, 12 Vdc output models			118	mA
	15 Vdc output models				
	15 Vdc input models:				
	5 Vdc output models			97	mA
	15 Vdc output models			94	mA
	24 Vdc input models:				
3.3 Vdc output models				65	mA
	5, 9, 12, 15 Vdc output models			63	mA
filter	capacitance filter				

OUTPUT

parameter	conditions/description	min	typ	max	units
maximum capacitive load ⁴	3.3, 5 Vdc output models			2,400	μF
	9 Vdc output models			1,000	μF
	12, 15 Vdc output models			560	μF
voltage accuracy				±3	%
line regulation	for Vin change of 1%			±0.25	%
load regulation	from 10% to full load			±3	%
	3.3 Vdc output models			±2	%
all other models					
switching frequency	100% load, nominal input voltage		260		kHz
temperature coefficient	at full load		±0.02		%/°C

Note: 4. Tested at input voltage range and full load.

PROTECTIONS

parameter	conditions/description	min	typ	max	units
short circuit protection	continuous, auto recovery				

SAFETY AND COMPLIANCE

parameter	conditions/description	min	typ	max	units
isolation voltage	input to output for 1 min, < 1 mA	1,500			Vdc
isolation resistance	input to output at 500 Vdc	1,000			MΩ
isolation capacitance	input to output, 100 kHz / 0.1 V		20		pF
safety approvals	designed to meet 62368-1: EN/BS EN				
conducted emissions	CISPR32/EN55032 CLASS B (see Fig. 2 for recommended circuit)				
radiated emissions	CISPR32/EN55032 CLASS B (see Fig. 2 for recommended circuit)				
ESD	IEC/EN61000-4-2 Contact ±6kV				
MTBF	as per MIL-HDBK-217F, 25°C	3,500,000			hours
RoHS	yes				

ENVIRONMENTAL

parameter	conditions/description	min	typ	max	units
operating temperature	see derating curves	-40		85	°C
storage temperature		-55		125	°C
storage humidity	non-condensing	5		95	%
case temperature rise	at 25°C		30		°C

DERATING CURVE

TEMPERATURE DERATING CURVE

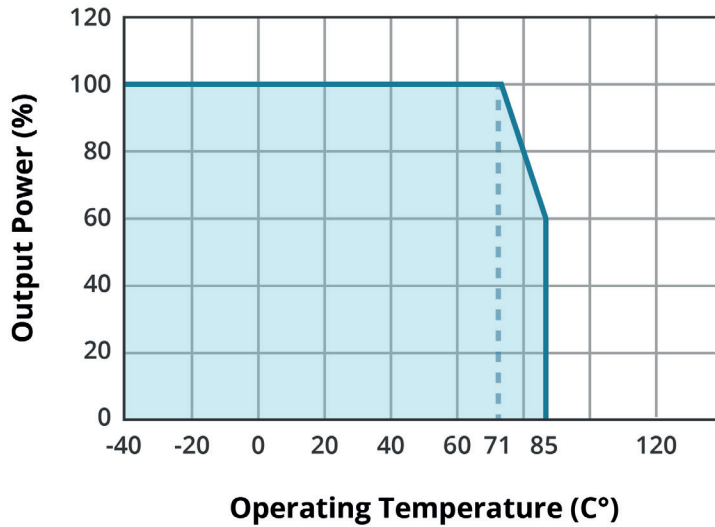

EFFICIENCY CURVES

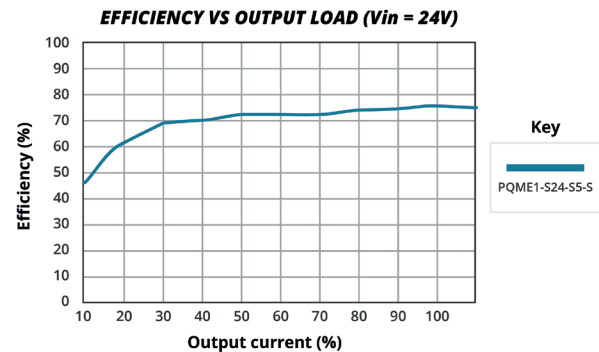
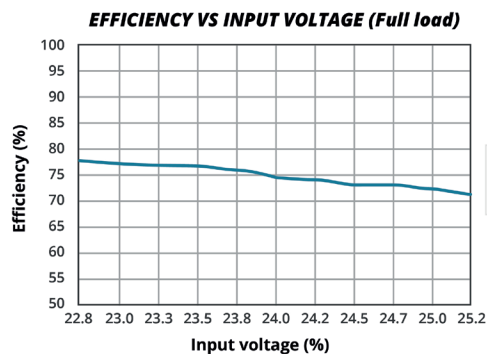
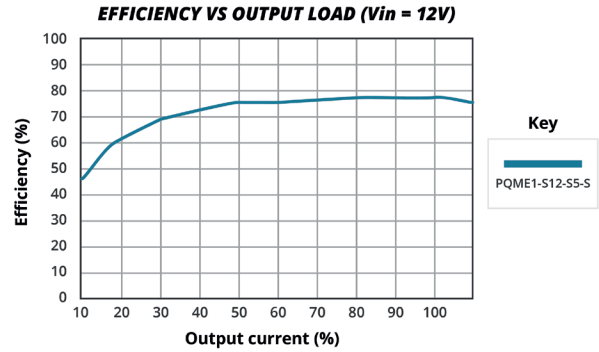
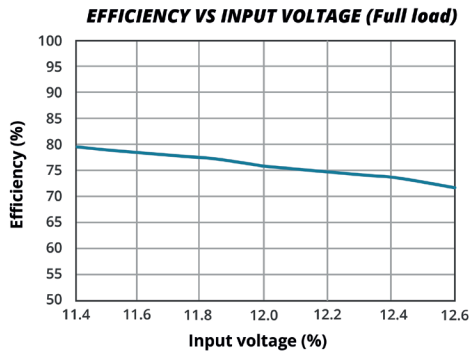

SOLDERABILITY

parameter	conditions/description	min	typ	max	units
soldering resistance temperature	soldering spot is 1.5mm away from case for 10 seconds			300	°C

MECHANICAL

parameter	conditions/description	min	typ	max	units
dimensions	19.65 x 6.00 x 10.16 [0.773 x 0.236 x 0.400 inch]				mm
case material	black flame-retardant and heat-resistant plastic (UL94V-0)				
weight			2.1		g
cooling method	natural convection				

MECHANICAL DRAWING

units: mm [inch]
 tolerance: ±0.25[±0.010]
 pin section tolerance: ±0.10[±0.004]

PIN CONNECTIONS	
PIN	Function
1	+Vin
2	GND
4	0V
6	+Vo

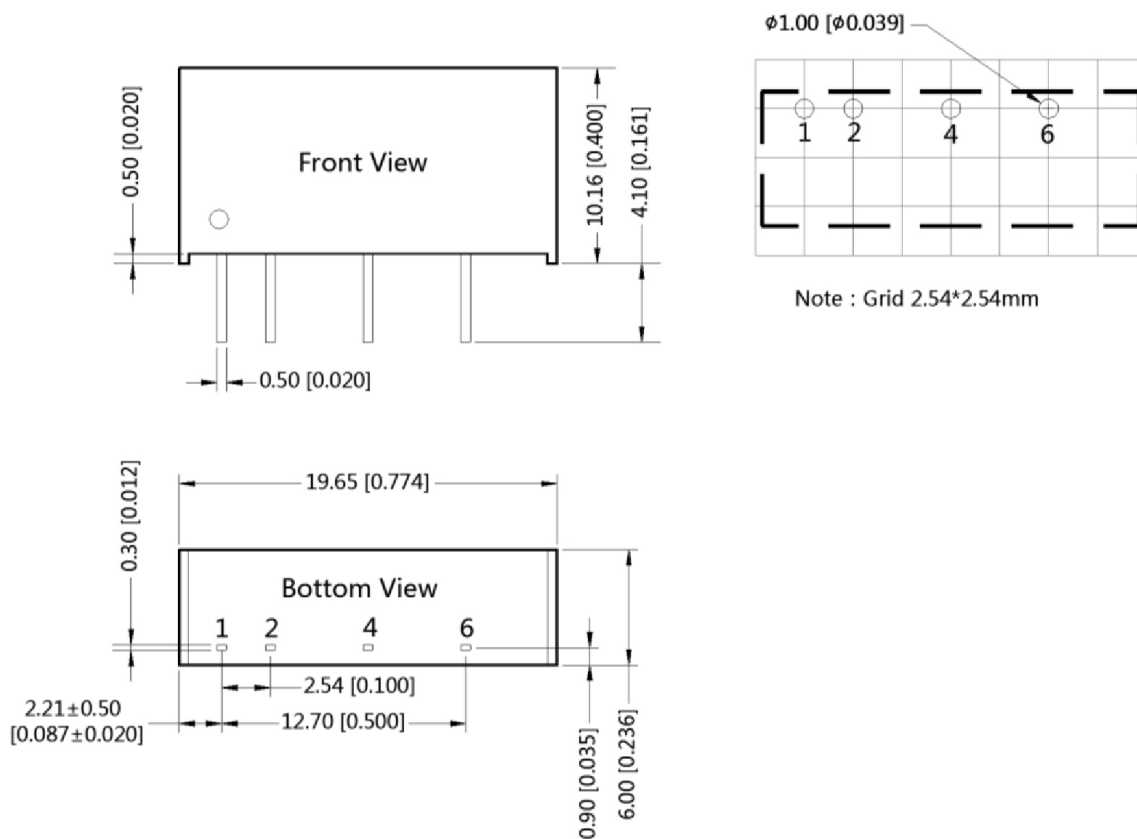

APPLICATION CIRCUIT

If you want to further reduce the input and output ripple, a filter capacitor may be connected to the input and output terminals (Figure 1) provided that the capacitance is less than the maximum capacitive load of the model, otherwise start-up problems may be caused if the capacitance is too large.

Figure 1

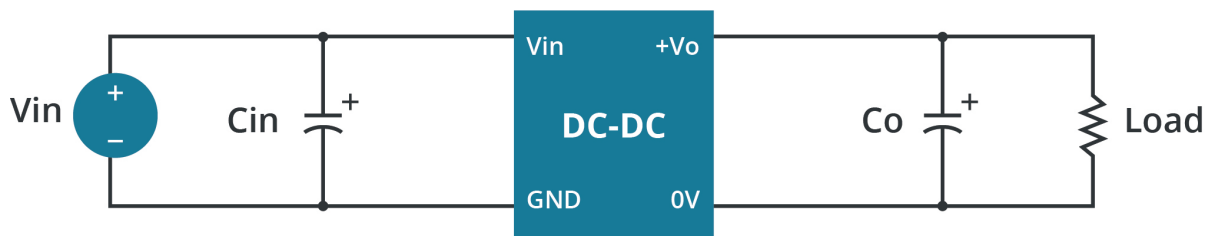

Table 1

Vin (Vdc)	Cin (μF/V)	Vo (Vdc)	Cout (μF/V)
12	2.2/25	3.3	10/16
15	2.2/25	5	10/16
24	1.0/50	9	2.2/16
--	--	12	2.2/25
--	--	15	1.0/25

EMC RECOMMENDED CIRCUIT

Figure 2

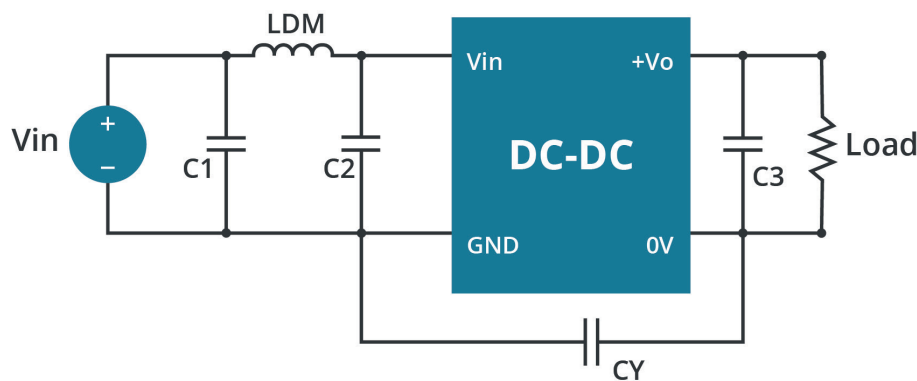

Table 2

Emissions	Recommended EMC filter values	
	C1	4.7μF/50V
	C2	4.7μF/50V
	CY	270pF/2kV
	C3	refer to the Cout in Table 1
	LDM	6.8μH

REVISION HISTORY

rev.	description	date
1.0	initial release	03/08/2021
1.01	pin connections table updated	04/06/2021
1.02	CE removed	11/16/2022

The revision history provided is for informational purposes only and is believed to be accurate.



CUI INC
a bel group

Headquarters
20050 SW 112th Ave.
Tualatin, OR 97062
800.275.4899

Fax 503.612.2383
cui.com
techsupport@cui.com

CUI offers a two (2) year limited warranty. Complete warranty information is listed on our website.

CUI reserves the right to make changes to the product at any time without notice. Information provided by CUI is believed to be accurate and reliable. However, no responsibility is assumed by CUI for its use, nor for any infringements of patents or other rights of third parties which may result from its use.

CUI products are not authorized or warranted for use as critical components in equipment that requires an extremely high level of reliability. A critical component is any component of a life support device or system whose failure to perform can be reasonably expected to cause the failure of the life support device or system, or to affect its safety or effectiveness.