

3-Terminal 1A Positive Voltage Regulator

Description

The 78MXX series of three-terminal positive regulators are available in the TO-220C/TO-252 package with several fixed output voltages making it useful in a wide range of applications.

Features

- ◆ Output Current up to 1A
- ◆ Output Voltages of 5,6,8,10,12,15,18,20,24V
- ◆ Thermal Overload Protection
- ◆ Short Circuit Protection
- ◆ Output Transistor Safe Operating area (SOA)Protection

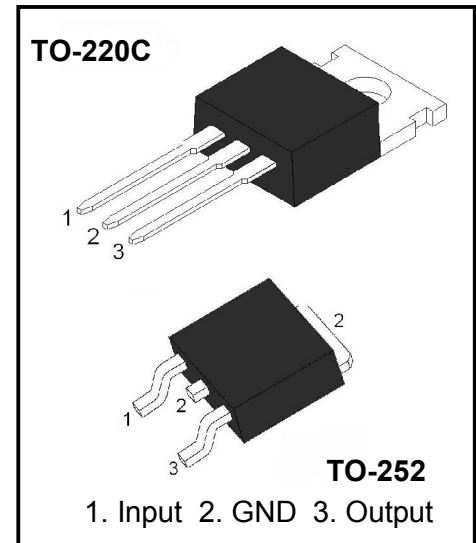

Internal Block Diagram

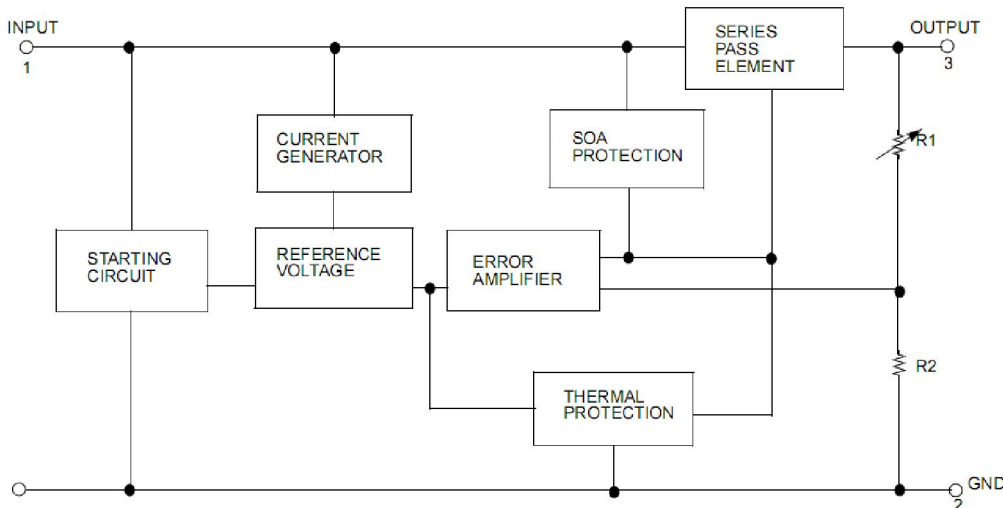

Absolute Maximum Ratings

Parameter		Symbol	Value	Unit
Input Voltage	$V_O = 5V \sim 18V$	V_{IN}	35	V
	$V_O = 24V$		40	
Thermal Resistance Junction-Cases (TO-220C)		$R_{\theta JC}$	5	$^{\circ}C/W$
Thermal Resistance Junction-Air	TO-220C	$R_{\theta JA}$	65	$^{\circ}C/W$
	TO-252		92	
Operating Temperature Range		T_{OPR}	$0 \sim +125$	$^{\circ}C$
Storage Temperature Range		T_{STG}	$-55 \sim +150$	$^{\circ}C$

Note1 Absolute maximum ratings are those values beyond which damage to the device may occur. The datasheet specifications should be met, without exception, to ensure that the system design is reliable over its power supply, temperature, and output/input loading variables. Fairchild does not recommend operation outside datasheet specifications.

Electrical Characteristics (78M05)

($V_I = 10V$, $I_O = 0.5A$, $C_I = 0.33\mu F$, $C_O = 0.1\mu F$, $T_J = -40^\circ C$ to $125^\circ C$, unless otherwise specified)

Parameter	Symbol	Conditions	Min	Typ	Max	Unit
Output Voltage	V_O	$T_J = 25^\circ C$, $I_O = 5mA \sim 1A$	4.80	5.0	5.20	V
		$V_I = 7V \sim 20V$, $I_O = 5mA \sim 1A$	4.75	5.0	5.25	V
Line Regulation ②	ΔV_O	$T_J = 25^\circ C$	$V_I = 7V \sim 25V$		100	mV
			$V_I = 8V \sim 12V$		50	
Load Regulation ②	ΔV_O	$T_J = 25^\circ C$	$I_O = 5mA \sim 1A$		100	mV
			$I_O = 0.25A \sim 0.75A$		50	
Quiescent Current	I_Q	$T_J = 25^\circ C$			8.0	mA
Quiescent Current Change	ΔI_Q	$I_O = 5mA \sim 1A$			0.5	mA
		$V_I = 7V \sim 25V$			1.3	
Output Voltage Drift ③	$\Delta V / \Delta T$	$I_O = 5mA$		-0.8		mV/°C
Output Noise Voltage	V_N	$10Hz \leq f \leq 100KHz$		42		$\mu V/V_O$
Ripple Rejection ③	RR	$f = 120Hz$, $V_I = 8V \sim 18V$	62	73		dB
Output Resistance ③	R_O	$f = 1kHz$		15		m Ω
Short Circuit Current	I_{SC}	$T_J = 25^\circ C$, $V_I = 30V$		230		mA
Peak Out Current ③	I_{PK}	$T_J = 25^\circ C$		1.8		A
Dropout Voltage	V_d	$T_J = 25^\circ C$, $I_O = 1A$		2.0		V

Note 2: Load and line regulation are specified at constant junction temperature. Changes in V_O due to heating effects must be taken into account separately. Pulse testing with low duty is used.

Note 3: These parameters, although guaranteed, are not 100% tested in production.

Electrical Characteristics (78M06)

($V_I = 11V$, $I_O = 0.5A$, $C_I = 0.33\mu F$, $C_O = 0.1\mu F$, $T_j = -40$ to $125^\circ C$, unless otherwise specified)

Parameter	Symbol	Conditions	Min	Typ	Max	Unit
Output Voltage	V_O	$T_j = 25^\circ C$, $I_O = 5mA \sim 1A$	5.76	6.0	6.24	V
		$V_I = 8V \sim 12V$, $I_O = 5mA \sim 1A$	5.70	6.0	6.30	V
Line Regulation ④	ΔV_O	$T_j = 25^\circ C$	$V_I = 8V \sim 25V$		120	mV
			$V_I = 9V \sim 13V$		60	
Load Regulation ④	ΔV_O	$T_j = 25^\circ C$	$I_O = 5mA \sim 1A$		120	mV
			$I_O = 0.25A \sim 0.75A$		60	
Quiescent Current	I_Q	$T_j = 25^\circ C$			8.0	mA
Quiescent Current Change	ΔI_Q	$I_O = 5mA \sim 1A$			0.5	mA
		$V_I = 8V \sim 25V$			1.3	
Output Voltage Drift ⑤	$\Delta V / \Delta T$	$I_O = 5mA$		-0.8		mV/°C
Output Noise Voltage	V_N	$10Hz \leq f \leq 100KHz$		76		$\mu V/V_O$
Ripple Rejection ⑤	RR	$f = 120Hz, V_I = 8V \sim 18V$	55	71		dB
Output Resistance ⑤	R_O	$f = 1kHz$		19		m Ω
Short Circuit Current	I_{SC}	$T_j = 25^\circ C$, $V_I = 30V$		230		mA
Peak Out Current ⑤	I_{PK}	$T_j = 25^\circ C$		1.8		A
Dropout Voltage	V_d	$T_j = 25^\circ C$, $I_O = 1A$		2.0		V

Note 4: Load and line regulation are specified at constant junction temperature. Changes in V_O due to heating effects must be taken into account separately. Pulse testing with low duty is used.

Note 5: These parameters, although guaranteed, are not 100% tested in production.

Electrical Characteristics (78M08)

($V_I = 14V$, $I_O = 0.5A$, $C_I = 0.33\mu F$, $C_O = 0.1\mu F$, $T_j = -40$ to $125^\circ C$, unless otherwise specified)

Parameter	Symbol	Conditions	Min	Typ	Max	Unit
Output Voltage	V_O	$T_j = 25^\circ C$, $I_O = 5mA \sim 1A$	7.68	8.0	8.32	V
		$V_I = 10.5V \sim 23V$, $I_O = 5mA \sim 1A$	7.60	8.0	8.40	V
Line Regulation ⑥	ΔV_O	$T_j = 25^\circ C$	$V_I = 10.5V \sim 25V$		160	mV
			$V_I = 11.5V \sim 17V$		80	
Load Regulation ⑥	ΔV_O	$T_j = 25^\circ C$	$I_O = 5mA \sim 1A$		160	mV
			$I_O = 0.25A \sim 0.75A$		80	
Quiescent Current	I_Q	$T_j = 25^\circ C$			8.0	mA
Quiescent Current Change	ΔI_Q	$I_O = 5mA \sim 1A$			0.5	mA
		$V_I = 10.5V \sim 25V$			1.0	
Output Voltage Drift ⑦	$\Delta V / \Delta T$	$I_O = 5mA$		-0.8		mV/ $^\circ C$
Output Noise Voltage	V_N	$10Hz \leq f \leq 100KHz$		52		$\mu V/V_O$
Ripple Rejection ⑦	RR	$f = 120Hz$, $V_I = 11.5V \sim 21.5V$	56	73		dB
Output Resistance ⑦	R_O	$f = 1kHz$		17		m Ω
Short Circuit Current	I_{SC}	$T_j = 25^\circ C$, $V_I = 30V$		230		mA
Peak Out Current ⑦	I_{PK}	$T_j = 25^\circ C$		1.8		A
Dropout Voltage	V_d	$T_j = 25^\circ C$, $I_O = 1A$		2.0		V

Note 6: Load and line regulation are specified at constant junction temperature. Changes in V_O due to heating effects must be taken into account separately. Pulse testing with low duty is used.

Note 7: These parameters, although guaranteed, are not 100% tested in production.

Electrical Characteristics (78M09)

($V_I = 15V$, $I_O = 0.5A$, $C_I = 0.33\mu F$, $C_O = 0.1\mu F$, $T_J = -40$ to $125^\circ C$, unless otherwise specified)

Parameter	Symbol	Conditions	Min	Typ	Max	Unit
Output Voltage	V_O	$T_J = 25^\circ C$, $I_O = 5mA \sim 1A$	8.64	9.0	9.36	V
		$V_I = 11.5V \sim 24V$, $I_O = 5mA \sim 1A$	8.55	9.0	9.45	V
Line Regulation ⑧	ΔV_O	$T_J = 25^\circ C$	$V_I = 11.5V \sim 25V$		180	mV
			$V_I = 12V \sim 17V$		90	
Load Regulation ⑧	ΔV_O	$T_J = 25^\circ C$	$I_O = 5mA \sim 1A$		180	mV
			$I_O = 0.25A \sim 0.75A$		90	
Quiescent Current	I_Q	$T_J = 25^\circ C$			8.0	mA
Quiescent Current Change	ΔI_Q	$I_O = 5mA \sim 1A$			0.5	mA
		$V_I = 11.5V \sim 26V$			1.3	
Output Voltage Drift ⑨	$\Delta V / \Delta T$	$I_O = 5mA$		-1.0		mV/°C
Output Noise Voltage	V_N	$10Hz \leq f \leq 100KHz$		52		$\mu V/V_O$
Ripple Rejection ⑨	RR	$f = 120Hz$, $V_I = 13V \sim 23V$	56	71		dB
Short Circuit Current	I_{SC}	$T_J = 25^\circ C$, $V_I = 30V$		230		mA
Output Resistance ⑨	R_O	$f = 1kHz$		17		m Ω
Peak Out Current ⑨	I_{PK}	$T_J = 25^\circ C$		1.8		A
Dropout Voltage	V_d	$T_J = 25^\circ C$, $I_O = 1A$		2.0		V

Note 8: Load and line regulation are specified at constant junction temperature. Changes in V_O due to heating effects must be taken into account separately. Pulse testing with low duty is used.

Note 9: These parameters, although guaranteed, are not 100% tested in production.

Electrical Characteristics (78M10)

($V_I = 16V$, $I_O = 0.5A$, $C_I = 0.33\mu F$, $C_O = 0.1\mu F$, $T_j = -40$ to $125^\circ C$, unless otherwise specified)

Parameter	Symbol	Conditions	Min	Typ	Max	Unit
Output Voltage	V_O	$T_j = 25^\circ C$, $I_O = 5mA \sim 1A$	9.60	10.0	10.40	V
		$V_I = 12.5V \sim 25V$, $I_O = 5mA \sim 1A$	9.50	10.0	10.50	V
Line Regulation ⑩	ΔV_O	$T_j = 25^\circ C$	$V_I = 12.5V \sim 25V$		200	mV
			$V_I = 13V \sim 25V$		100	
Load Regulation ⑩	ΔV_O	$T_j = 25^\circ C$	$I_O = 5mA \sim 1A$		200	mV
			$I_O = 0.25A \sim 0.75A$		100	
Quiescent Current	I_Q	$T_j = 25^\circ C$			8.0	mA
Quiescent Current Change	ΔI_Q	$I_O = 5mA \sim 1A$			0.5	mA
		$V_I = 12.5V \sim 29V$			1.0	
Output Voltage Drift ⑪	$\Delta V / \Delta T$	$I_O = 5mA$		-1.0		mV/ $^\circ C$
Output Noise Voltage	V_N	$10Hz \leq f \leq 100KHz$		58		$\mu V/V_O$
Ripple Rejection ⑫	RR	$f = 120Hz$, $V_I = 13V \sim 23V$	56	71		dB
Short Circuit Current	I_{SC}	$T_j = 25^\circ C$, $V_I = 30V$		230		mA
Output Resistance ⑬	R_O	$f = 1kHz$		17		m Ω
Peak Out Current ⑭	I_{PK}	$T_j = 25^\circ C$		1.8		A
Dropout Voltage	V_d	$T_j = 25^\circ C$, $I_O = 1A$		2.0		V

Note 10: Load and line regulation are specified at constant junction temperature. Changes in V_O due to heating effects must be taken into account separately. Pulse testing with low duty is used.

Note 11: These parameters, although guaranteed, are not 100% tested in production.

Electrical Characteristics (78M12)

($V_I = 19V$, $I_O = 0.5A$, $C_I = 0.33\mu F$, $C_O = 0.1\mu F$, $T_J = -40$ to $125^\circ C$, unless otherwise specified)

Parameter	Symbol	Conditions	Min	Typ	Max	Unit
Output Voltage	V_O	$T_J = 25^\circ C$, $I_O = 5mA \sim 1A$	11.52	12.0	12.48	V
		$V_I = 14.5V \sim 27V$, $I_O = 5mA \sim 1A$	11.40	12.0	12.60	V
Line Regulation ⑫	ΔV_O	$T_J = 25^\circ C$ $I_O = 0.5A$	$V_I = 14.5V \sim 30V$		240	mV
			$V_I = 11.5V \sim 24V$		120	
Load Regulation ⑫	ΔV_O	$T_J = 25^\circ C$,	$I_O = 5mA \sim 1A$		240	mV
			$I_O = 0.25A \sim 0.75A$		120	
Quiescent Current	I_Q	$T_J = 25^\circ C$			8.0	mA
Quiescent Current Change	ΔI_Q	$I_O = 5mA \sim 1A$			0.5	mA
		$V_I = 14.5V \sim 30V$			1.0	
Output Voltage Drift ⑬	$\Delta V / \Delta T$	$I_O = 5mA$		-1.0		mV/ $^\circ C$
Output Noise Voltage	V_N	$10Hz \leq f \leq 100KHz$		76		$\mu V/V_O$
Ripple Rejection ⑬	RR	$f = 120Hz$, $V_I = 15V \sim 25V$	55	71		dB
Output Resistance ⑬	R_O	$f = 1kHz$		18		m Ω
Short Circuit Current	I_{SC}	$T_J = 25^\circ C$, $V_I = 30V$		230		mA
Peak Out Current ⑬	I_{PK}	$T_J = 25^\circ C$		1.8		A
Dropout Voltage	V_d	$T_J = 25^\circ C$, $I_O = 1A$		2.0		V

Note 12: Load and line regulation are specified at constant junction temperature. Changes in V_O due to heating effects must be taken into account separately. Pulse testing with low duty is used.

Note 13: These parameters, although guaranteed, are not 100% tested in production.

Electrical Characteristics (78M15)

($V_I = 23V$, $I_O = 0.5A$, $C_I = 0.33\mu F$, $C_O = 0.1\mu F$, $T_J = -40$ to $125^\circ C$, unless otherwise specified)

Parameter	Symbol	Conditions	Min	Typ	Max	Unit
Output Voltage	V_O	$T_J = 25^\circ C$, $I_O = 5mA \sim 1A$	14.40	15.0	15.60	V
		$V_I = 17.5V \sim 30V$, $I_O = 5mA \sim 1A$	14.25	15.0	15.75	V
Line Regulation ⑭	ΔV_O	$T_J = 25^\circ C$ $I_O = 0.5A$	$V_I = 17.5V \sim 30V$		300	mV
			$V_I = 20V \sim 26V$		150	
Load Regulation ⑭	ΔV_O	$T_J = 25^\circ C$,	$I_O = 5mA \sim 1A$		300	mV
			$I_O = 0.25A \sim 0.75A$		150	
Quiescent Current	I_Q	$T_J = 25^\circ C$			8.0	mA
Quiescent Current Change	ΔI_Q	$I_O = 5mA \sim 1A$			0.5	mA
		$V_I = 17.5V \sim 30V$			1.0	
Output Voltage Drift ⑮	$\Delta V / \Delta T$	$I_O = 5mA$		-1.0		mV/ $^\circ C$
Output Noise Voltage	V_N	$10Hz \leq f \leq 100KHz$		90		$\mu V/V_O$
Ripple Rejection ⑮	RR	$f = 120Hz$, $V_I = 18.5V \sim 28.5V$	54	70		dB
Output Resistance ⑮	R_O	$f = 1kHz$		19		m Ω
Short Circuit Current	I_{SC}	$T_J = 25^\circ C$, $V_I = 30V$		230		mA
Peak Out Current ⑮	I_{PK}	$T_J = 25^\circ C$		1.8		A
Dropout Voltage	V_d	$T_J = 25^\circ C$, $I_O = 1A$		2.0		V

Note 14: Load and line regulation are specified at constant junction temperature. Changes in V_O due to heating effects must be taken into account separately. Pulse testing with low duty is used.

Note 15: These parameters, although guaranteed, are not 100% tested in production.

Electrical Characteristics (78M18)

($V_I = 27V$, $I_O = 0.5A$, $C_I = 0.33\mu F$, $C_O = 0.1\mu F$, $T_J = -40$ to $125^\circ C$, unless otherwise specified)

Parameter	Symbol	Conditions	Min	Typ	Max	Unit
Output Voltage	V_O	$T_J = 25^\circ C$, $I_O = 5mA \sim 1A$	17.28	18.0	18.72	V
		$V_I = 21V \sim 30V$, $I_O = 5mA \sim 1A$	17.10	18.0	18.90	V
Line Regulation ⑩	ΔV_O	$T_J = 25^\circ C$ $I_O = 0.5A$	$V_I = 21V \sim 30V$		360	mV
			$V_I = 24V \sim 26V$		180	
Load Regulation ⑩	ΔV_O	$T_J = 25^\circ C$,	$I_O = 5mA \sim 1A$		300	mV
			$I_O = 0.25A \sim 0.75A$		150	
Quiescent Current	I_Q	$T_J = 25^\circ C$			8.0	mA
Quiescent Current Change	ΔI_Q	$I_O = 5mA \sim 1A$			0.5	mA
		$V_I = 21V \sim 30V$			1.0	
Output Voltage Drift ⑪	$\Delta V / \Delta T$	$I_O = 5mA$		-1.0		mV/ $^\circ C$
Output Noise Voltage	V_N	$10Hz \leq f \leq 100KHz$		110		$\mu V/V_O$
Ripple Rejection ⑫	RR	$f = 120Hz$, $V_I = 22V \sim 30V$	53	69		dB
Output Resistance ⑬	R_O	$f = 1kHz$		22		m Ω
Short Circuit Current	I_{SC}	$T_J = 25^\circ C$, $V_I = 30V$		230		mA
Peak Out Current ⑭	I_{PK}	$T_J = 25^\circ C$		1.8		A
Dropout Voltage	V_d	$T_J = 25^\circ C$, $I_O = 1A$		2.0		V

Note 16: Load and line regulation are specified at constant junction temperature. Changes in V_O due to heating effects must be taken into account separately. Pulse testing with low duty is used.

Note 17: These parameters, although guaranteed, are not 100% tested in production.

Electrical Characteristics (78M24)

($V_I = 33V$, $I_O = 0.5A$, $C_I = 0.33\mu F$, $C_O = 0.1\mu F$, $T_J = -40$ to $125^\circ C$, unless otherwise specified)

Parameter	Symbol	Conditions	Min	Typ	Max	Unit
Output Voltage	V_O	$T_J = 25^\circ C$, $I_O = 5mA \sim 1A$	23.04	24.0	24.96	V
		$V_I = 27V \sim 38V$, $I_O = 5mA \sim 1A$	22.80	24.0	25.20	V
Line Regulation ⑱	ΔV_O	$T_J = 25^\circ C$ $I_O = 0.5A$	$V_I = 27V \sim 38V$		480	mV
			$V_I = 30V \sim 36V$		240	
Load Regulation ⑱	ΔV_O	$T_J = 25^\circ C$,	$I_O = 5mA \sim 1A$		480	mV
			$I_O = 0.25A \sim 0.75A$		240	
Quiescent Current	I_Q	$T_J = 25^\circ C$			8.0	mA
Quiescent Current Change	ΔI_Q	$I_O = 5mA \sim 1A$			0.5	mA
		$V_I = 27V \sim 38V$			1.0	
Output Voltage Drift ⑲	$\Delta V / \Delta T$	$I_O = 5mA$		-1.5		mV/ $^\circ C$
Output Noise Voltage	V_N	$10Hz \leq f \leq 100KHz$		60		$\mu V/V_O$
Ripple Rejection ⑲	RR	$f = 120Hz$, $V_I = 28V \sim 38V$	50	67		dB
Output Resistance ⑲	R_O	$f = 1kHz$		28		m Ω
Short Circuit Current	I_{SC}	$T_J = 25^\circ C$, $V_I = 35V$		230		mA
Peak Out Current ⑲	I_{PK}	$T_J = 25^\circ C$		1.8		A
Dropout Voltage	V_d	$T_J = 25^\circ C$, $I_O = 1A$		2.0		V

Note 18: Load and line regulation are specified at constant junction temperature. Changes in V_O due to heating effects must be taken into account separately. Pulse testing with low duty is used.

Note 19: These parameters, although guaranteed, are not 100% tested in production.

Typical Characteristics

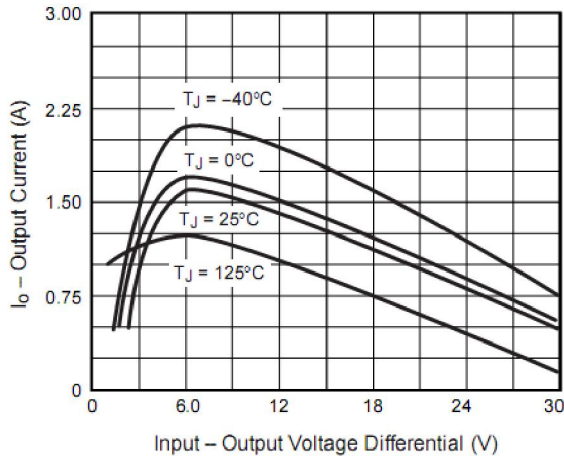

Figure 1. Peak Output Current

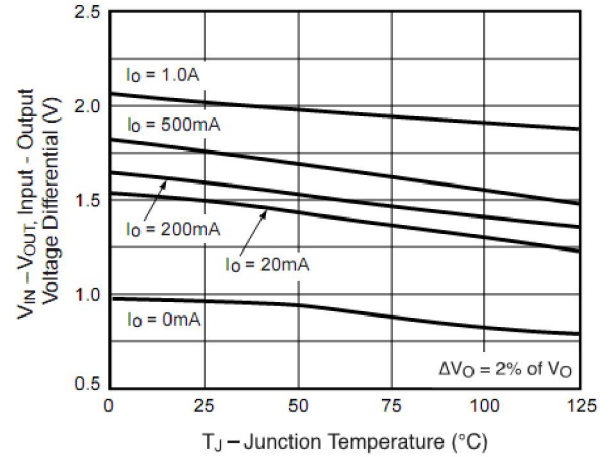

Figure 2. Dropout Voltage vs. Junction Temperature

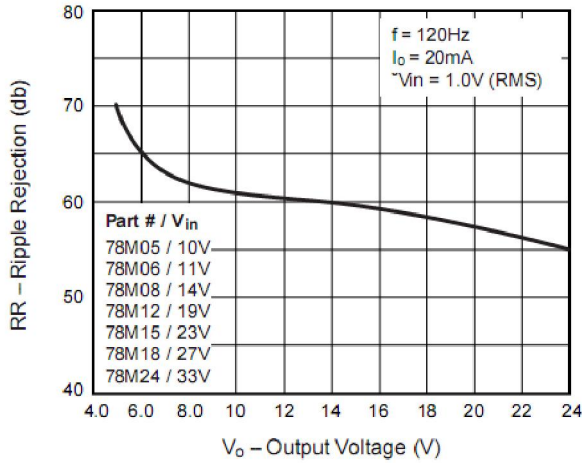

Figure 3. Ripple Rejection Ratio vs. Output Voltage

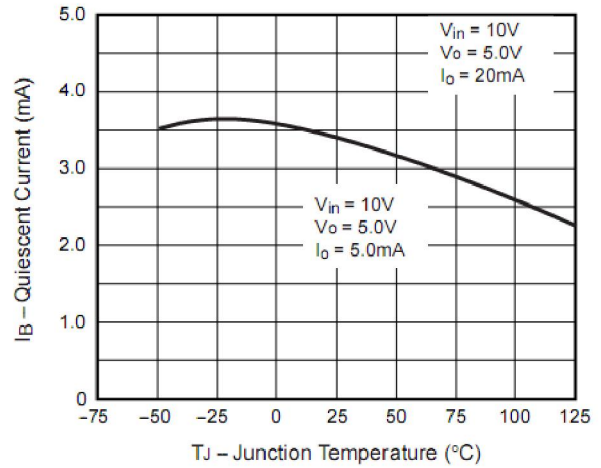

Figure 4. Quiescent Current vs. Junction Temperature

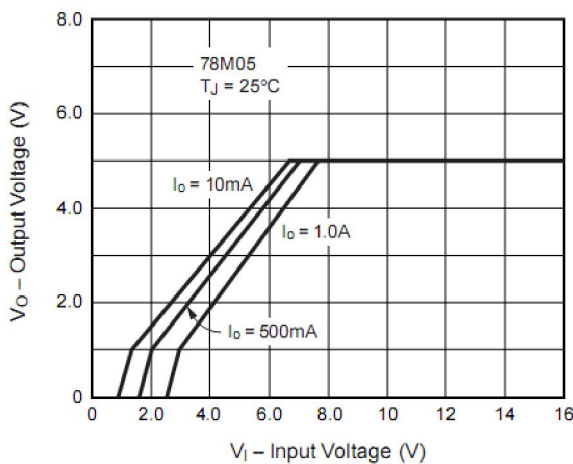

Figure 8. Output Voltage vs. Input Voltage

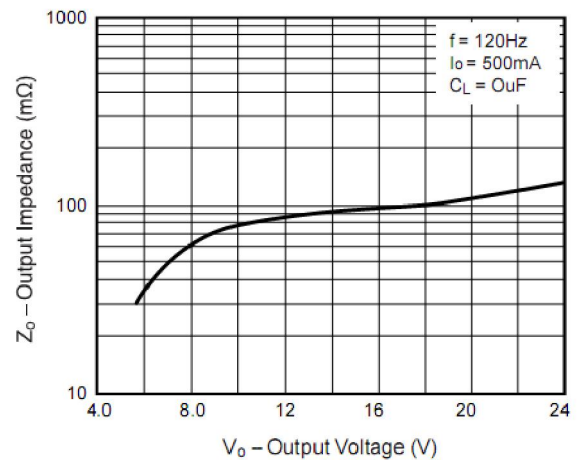
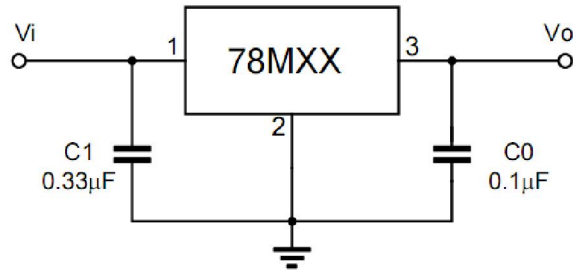

Figure 9. Output Impedance (mΩ) vs. Output Voltage

Application circuit



Note 1: To specify an output voltage, substitute voltage value for "MXX".

Note 2: Bypass capacitors are recommended for optimum stability and transient response and should be located as close as possible to the regulators.

Package Dimensions
TO-220C

Symbol	Millimeter		Inches	
	Min.	Max.	Min.	Max.
A	4.34	4.67	0.171	0.184
A1	2.52	2.82	0.099	0.111
b	0.71	0.91	0.028	0.036
b1	1.17	1.37	0.046	0.054
c	0.30	0.50	0.012	0.020
c1	1.17	1.37	0.046	0.054
D	9.90	10.20	0.390	0.402
E	8.50	8.90	0.335	0.350
E1	12.00	12.50	0.472	0.492
e	2.44	2.64	0.096	0.104
e1	4.88	5.28	0.192	0.208
F	2.60	2.80	0.102	0.110
L	13.20	13.80	0.520	0.543
L1	3.80	4.20	0.150	0.165
Φ	3.60	3.96	0.142	0.156

Package Dimensions

TO-252

Symbol	Millimeter		Inches	
	Min.	Max.	Min.	Max.
A	2.20	2.50	0.087	0.098
A1	0.00	0.12	0.000	0.005
A2	2.20	2.40	0.087	0.094
B	1.20	1.60	0.047	0.063
b	0.50	0.70	0.020	0.028
b1	0.70	0.90	0.028	0.035
c	0.40	0.60	0.016	0.024
c1	0.40	0.60	0.016	0.024
D	6.35	6.65	0.250	0.262
D1	5.20	5.40	0.205	0.213
E	5.40	5.70	0.213	0.224
e	2.20	2.40	0.087	0.094
e1	4.40	4.80	0.173	0.189
L	9.60	10.20	0.378	0.402
L1	2.70	3.10	0.106	0.122
L2	1.40	1.80	0.055	0.071
L3	0.90	1.50	0.035	0.059

