

LUXEON CoB Core Pro

Perfect for high-end retail and hospitality

Retail and hospitality lighting needs are crystal clear: very high efficacy and excellent quality of light that makes colors pop and encourages customers to engage with displays and products. LUXEON CoB Core Pro delivers the light and efficacy along with long-life and color stability for high value installations.



FEATURES AND BENEFITS

- Best in class efficacy and superior color quality
- Multiple LES sizes and flux output that fit different applications and requirements
- Superior thermal resistance enabling the use of smaller heatsinks and prolonged product life span
- Supported by a comprehensive optical, mechanical, and electrical ecosystem

PRIMARY APPLICATIONS

- Spotlights
- Track Lights
- Downlights
- Low Bay

Table of Contents

General Product Information	2
Product Test Conditions	2
Part Number Nomenclature	2
Lumen Maintenance	2
Environmental Compliance	2
Performance Characteristics	3
Product Selection Guide	3
Optical Characteristics	3
Electrical and Thermal Characteristics	3
Absolute Maximum Ratings	4
Characteristic Curves	5
Spectral Power Distribution Characteristics	5
Light Output Characteristics	5
Forward Current Characteristics	7
Radiation Pattern Characteristics	9
Color Bin Definitions	10
Mechanical Dimensions	11
Packaging Information	12
Tube Dimensions	12
Inner Box	14
Outer Box	15

General Product Information

Product Test Conditions

LUXEON CoB Core Pro LEDs are tested and binned with a DC drive current specified below at a junction temperature, T_j , of 85°C:

200mA	-	L2C5-AABB1202X09B0
300mA	-	L2C5-AABB1203X09B0
600mA	-	L2C5-AABB1205X13B0
900mA	-	L2C5-AABB1208X15B0
		L2C5-AABB1208X15B1
900mA	-	L2C5-AABB1210X15B0
1200mA	-	L2C5-AABB1211X19B0

Part Number Nomenclature

Part numbers for LUXEON CoB Core Pro follow the convention below:

L 2 C 5 – **A A B B C C C C D E E F F**

Where:

- A A** – designates nominal CCT (30=3000K)
- B B** – designates minimum CRI (90=90CRI)
- C C C C** – designates product configuration (example: 1202, 1203, 1205, 1208, 1210, 1211)
- D** – designates options for product specification
- E E** – designates light emitting surface (LES) size (09=9mm, 13=13mm, 15=15mm, 19=19mm)
- F F** – designates options for product specification

Therefore, the following part number is used for a LUXEON CoB Core Pro 3000K, 90CRI, 1208, 15mm LES:

L 2 C 5 – **3 0 9 0 1 2 0 8 X 1 5 B 0**

Lumen Maintenance

Please contact your local Sales Representative or Lumileds Technical Solutions Manager for more information about the long-term performance of this product.

Environmental Compliance

Lumileds LLC is committed to providing environmentally friendly products to the solid-state lighting market. LUXEON CoB Core Pro is compliant to the European Union directives on the restriction of hazardous substances in electronic equipment, namely the RoHS Directive 2011/65/EU and REACH Regulation (EC) 1907/2006. Lumileds LLC will not intentionally add the following restricted materials to its products: lead, mercury, cadmium, hexavalent chromium, polybrominated biphenyls (PBB) or polybrominated diphenyl ethers (PBDE).

Performance Characteristics

Product Selection Guide

Table 1. Product performance of LUXEON CoB Core Pro at specified test current, $T_j=85^\circ\text{C}$.

LES ^[4] (mm)	NOMINAL CCT	MINIMUM CRI ^[1, 2, 3]	LUMINOUS FLUX ^[1] (lm)		TYPICAL LUMINOUS EFFICACY (lm/W)	TEST CURRENT (mA)	ENERGY EFFICIENCY CLASS ^[5]	PART NUMBER
			MINIMUM	TYPICAL				
9	3000K	90	729	810	117	200	F	L2C5-30901202X09B0
9	3000K	90	1210	1344	130	300	E	L2C5-30901203X09B0
13	3000K	90	2462	2735	130	600	E	L2C5-30901205X13B0
15	3000K	90	3676	4084	130	900	E	L2C5-30901208X15B0
15	3000K	90	3780	4200	134	900	E	L2C5-30901208X15B1
15	3000K	90	3879	4310	141	900	E	L2C5-30901210X15B0
19	3000K	90	4959	5510	132	1200	E	L2C5-30901211X19B0

Notes for Table 1:

- Lumileds maintains a tolerance of ± 2 on CRI and $\pm 6.5\%$ on luminous flux measurements.
- Typical CRI is approximately 2 points higher than the minimum CRI specified, but this is not guaranteed.
- R9 value of 90CRI products is >50 .
- Light Emitting Surface (LES) is the inner diameter (phosphor area) inside the dam.
- Energy efficiency class as specified in Commission Delegated Regulation (EU) 2019/2015. The available range of energy efficiency classes is A-G.

Optical Characteristics

Table 2. Optical characteristics for LUXEON CoB Core Pro at specified test current, $T_j=85^\circ\text{C}$.

PART NUMBER	TYPICAL TOTAL INCLUDED ANGLE ^[1]	TYPICAL VIEWING ANGLE ^[2]
L2C5-xxxxxxx1202X09Bx	135°	115°

Notes for Table 2:

- Total angle at which 90% of total luminous flux is captured.
- Viewing angle is the off axis angle from the LED centerline where the luminous intensity is $\frac{1}{2}$ of the peak value.

Electrical and Thermal Characteristics

Table 3. Electrical and thermal characteristics for LUXEON CoB Core Pro at specified test current, $T_j=85^\circ\text{C}$.

PART NUMBER	FORWARD VOLTAGE ^[1] (V_f)			TYPICAL TEMPERATURE COEFFICIENT OF FORWARD VOLTAGE ^[2] (mV/°C)	TYPICAL THERMAL RESISTANCE—JUNCTION TO CASE ^[3] (°C/W)
	MINIMUM	TYPICAL	MAXIMUM		
L2C5-xxxx1202X09Bx	32.5	34.5	37.5	-16	0.98
L2C5-xxxx1203X09Bx	32.5	34.5	37.5	-16	0.62
L2C5-xxxx1205X13Bx	32.5	35.0	37.5	-16	0.37
L2C5-xxxx1208X15Bx	32.5	34.8	37.5	-16	0.25
L2C5-xxxx1210X15Bx	32.5	34.0	37.5	-16	0.20
L2C5-xxxx1211X19Bx	32.5	34.8	37.5	-16	0.18

Notes for Table 3:

- Lumileds maintains a tolerance of $\pm 0.06\text{V}$ on forward voltage measurements.
- Measured between 25°C and 85°C .
- Thermal resistance is measured between junction and the bottom of the LUXEON CoB substrate.

Absolute Maximum Ratings

Table 4. Absolute maximum ratings for LUXEON CoB Core Pro.

PARAMETER	MAXIMUM PERFORMANCE
DC Forward Current ^[1,2]	2x test current
LED Junction Temperature ^[1] (DC & Pulse)	125°C
ESD Sensitivity (ANSI/ESDA/JEDEC JS-001-2012)	Class 3B
Operating Case Temperature ^[1]	-40°C to 105°C
LED Storage Temperature	-40°C to 120°C
Allowable Reflow Cycles	3
Reverse Voltage ($V_{reverse}$)	LUXEON LEDs are not designed to be driven in reverse bias

Notes for Table 4:

1. Proper current derating must be observed to maintain the junction temperature below the maximum allowable junction temperature.
2. Residual periodic variations due to power conversion from alternating current (AC) to direct current (DC), also called "ripple," are acceptable if the following conditions are met:
 - The frequency of the ripple current is 100Hz or higher
 - The average current for each cycle does not exceed the maximum allowable DC forward current
 - The maximum amplitude of the ripple does not exceed the maximum peak pulsed forward current

Characteristic Curves

Spectral Power Distribution Characteristics

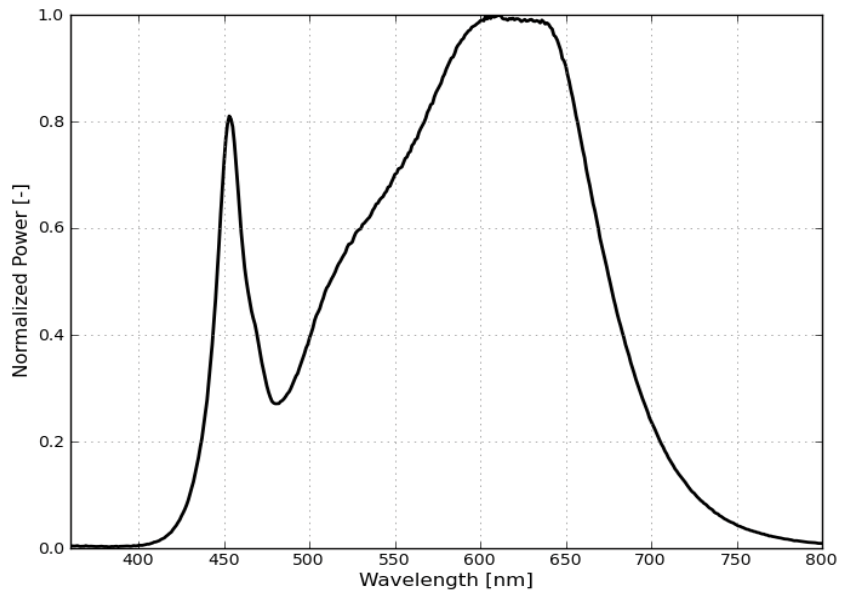

Figure 1. Typical normalized power vs. wavelength for L2C5-xxxxxxxXxxBx at specified test current, $T_j=85^{\circ}\text{C}$.

Light Output Characteristics

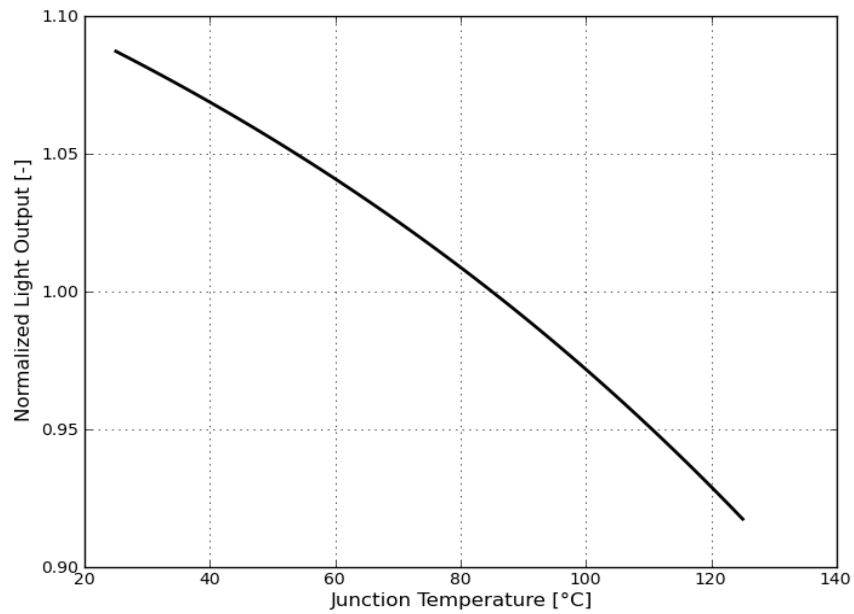

Figure 2. Typical normalized light output vs. junction temperature for L2C5-xxxx12xxExx00 at specified test current.

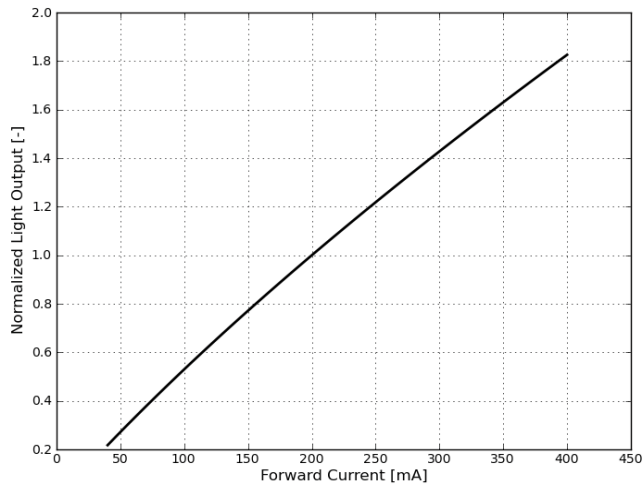

Figure 3a. Typical normalized light output vs. forward current for L2C5-xxxx1202XxxBx at $T_j=85^\circ\text{C}$.

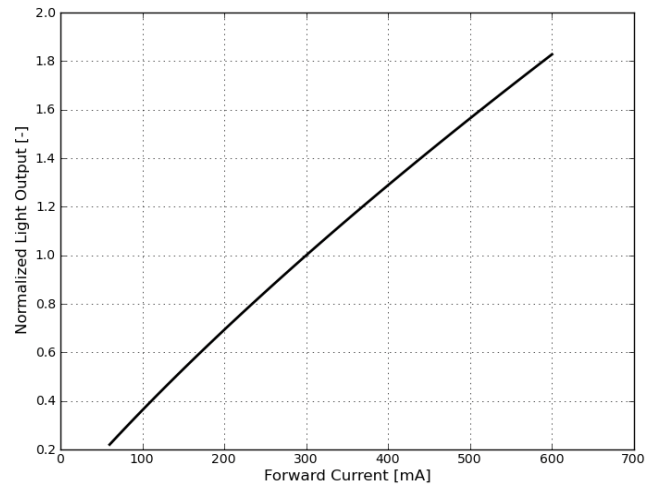

Figure 3b. Typical normalized light output vs. forward current for L2C5-xxxx1203XxxBx at $T_j=85^\circ\text{C}$.

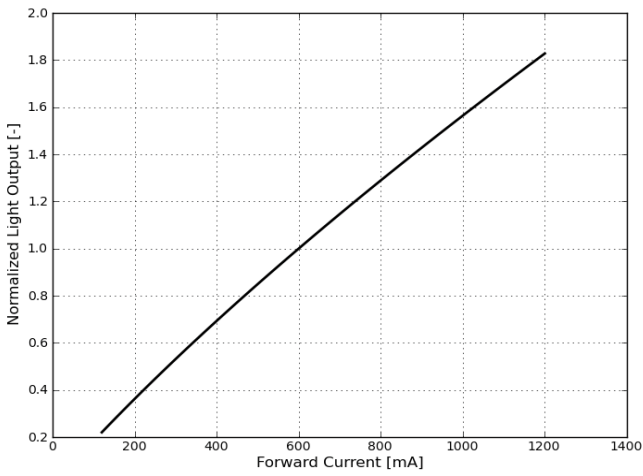

Figure 3c. Typical normalized light output vs. forward current for L2C5-xxxx1205XxxBx at $T_j=85^\circ\text{C}$.

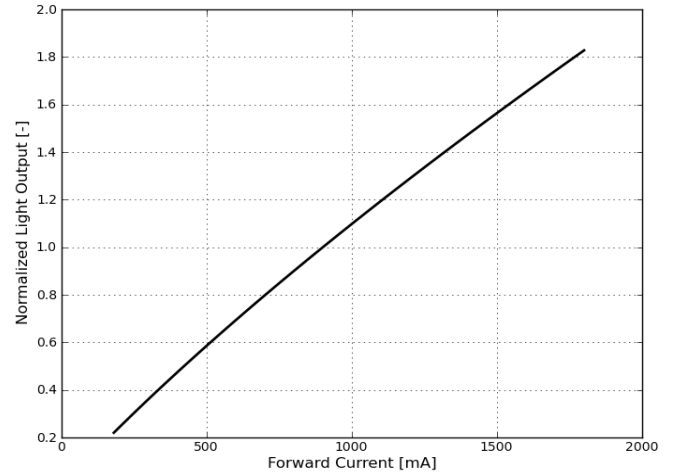

Figure 3d. Typical normalized light output vs. forward current for L2C5-xxxx1208XxxBx at $T_j=85^\circ\text{C}$.

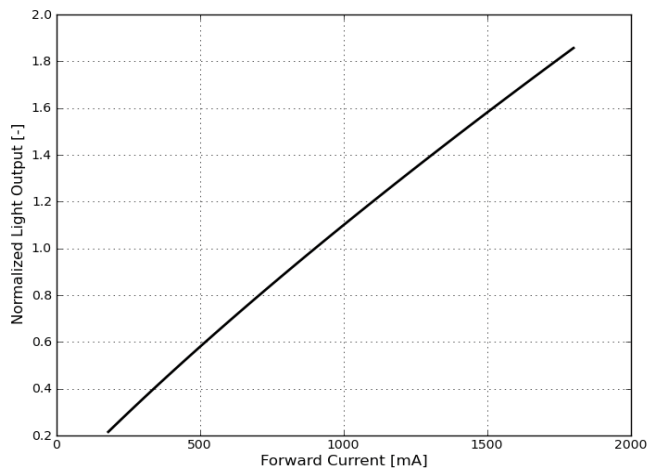

Figure 3e. Typical normalized light output vs. forward current for L2C5-xxxx1210XxxBx at $T_j=85^\circ\text{C}$.

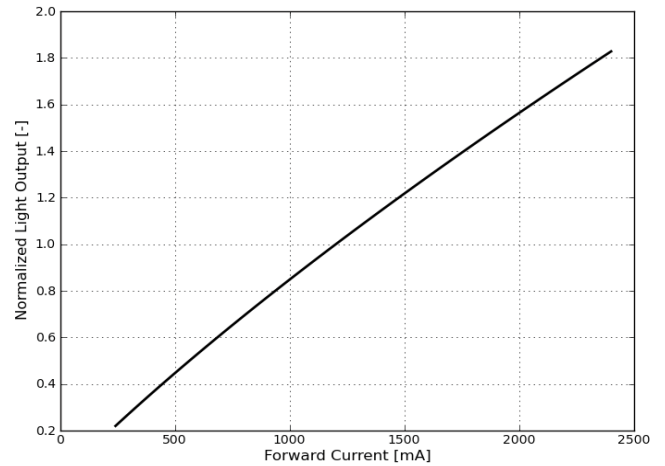

Figure 3f. Typical normalized light output vs. forward current for L2C5-xxxx1211XxxBx at $T_j=85^\circ\text{C}$.

Forward Current Characteristics

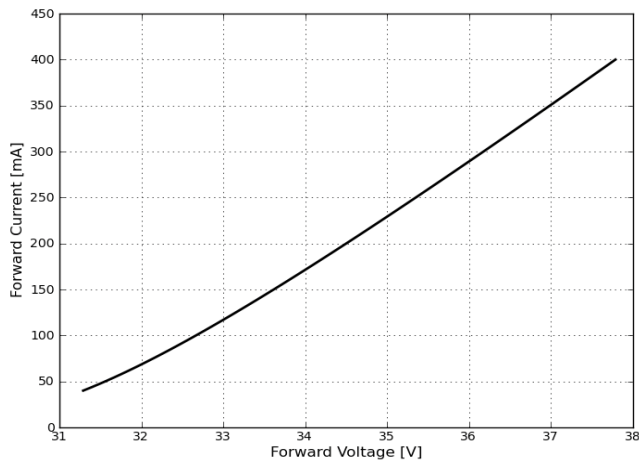

Figure 4a. Typical forward current vs. forward voltage for L2C5-xxxx1202XxxBx at $T_j=85^\circ\text{C}$.

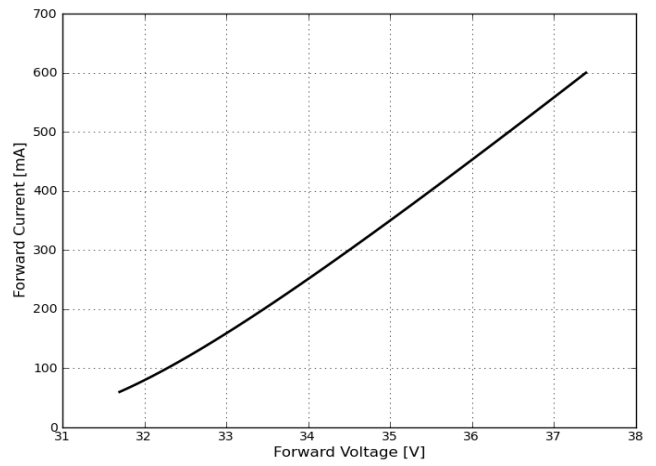

Figure 4b. Typical forward current vs. forward voltage for L2C5-xxxx1203XxxBx at $T_j=85^\circ\text{C}$.

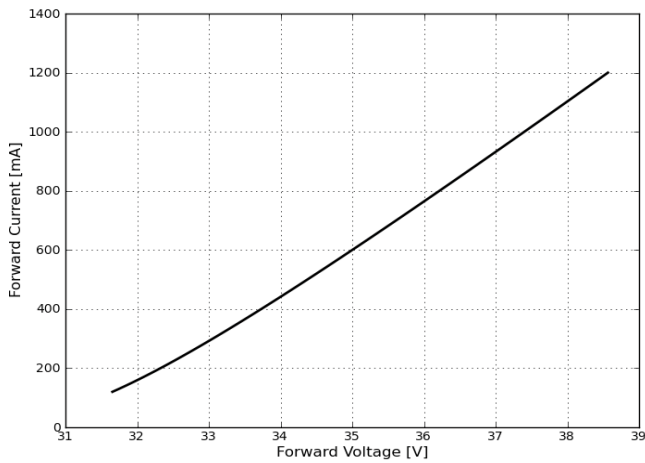

Figure 4c. Typical forward current vs. forward voltage for L2C5-xxxx1205XxxBx at $T_j=85^\circ\text{C}$.

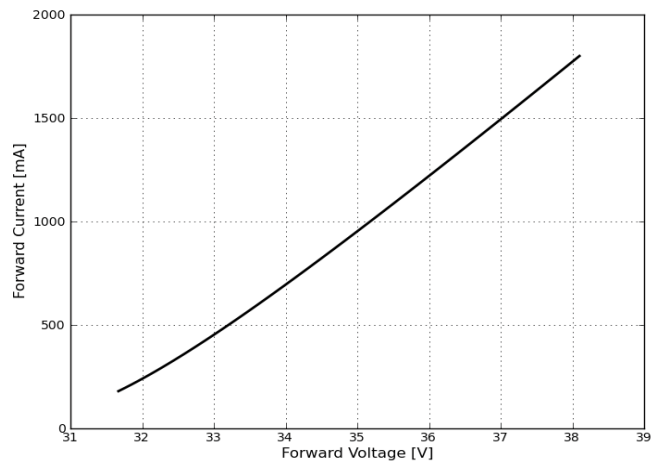

Figure 4d. Typical forward current vs. forward voltage for L2C5-xxxx1208XxxBx at $T_j=85^\circ\text{C}$.

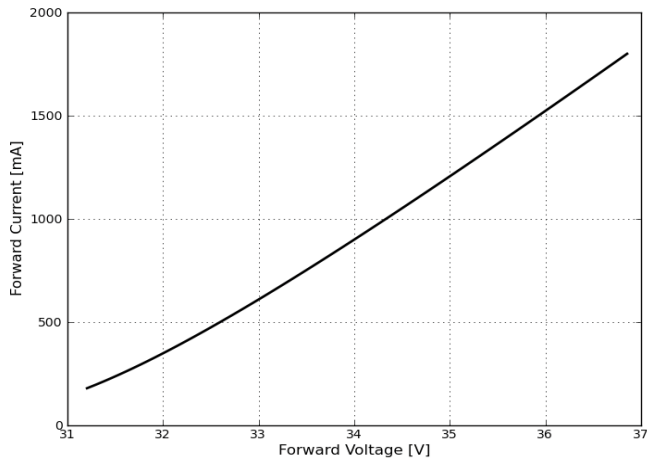

Figure 4e. Typical forward current vs. forward voltage for L2C5-xxxx1210XxxBx at $T_j=85^\circ\text{C}$.

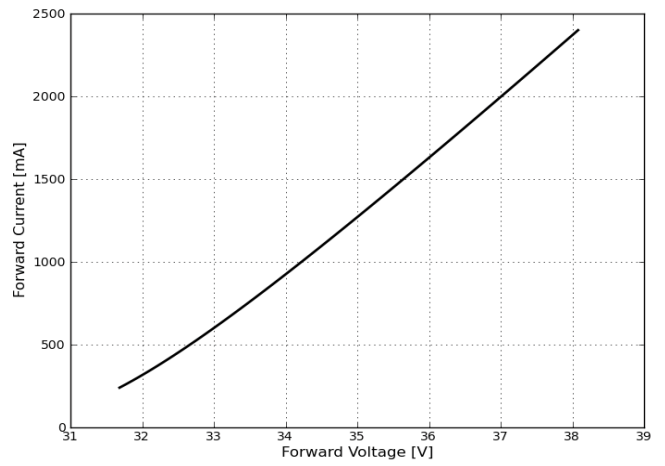

Figure 4f. Typical forward current vs. forward voltage for L2C5-xxxx1211XxxBx at $T_j=85^\circ\text{C}$.

Radiation Pattern Characteristics

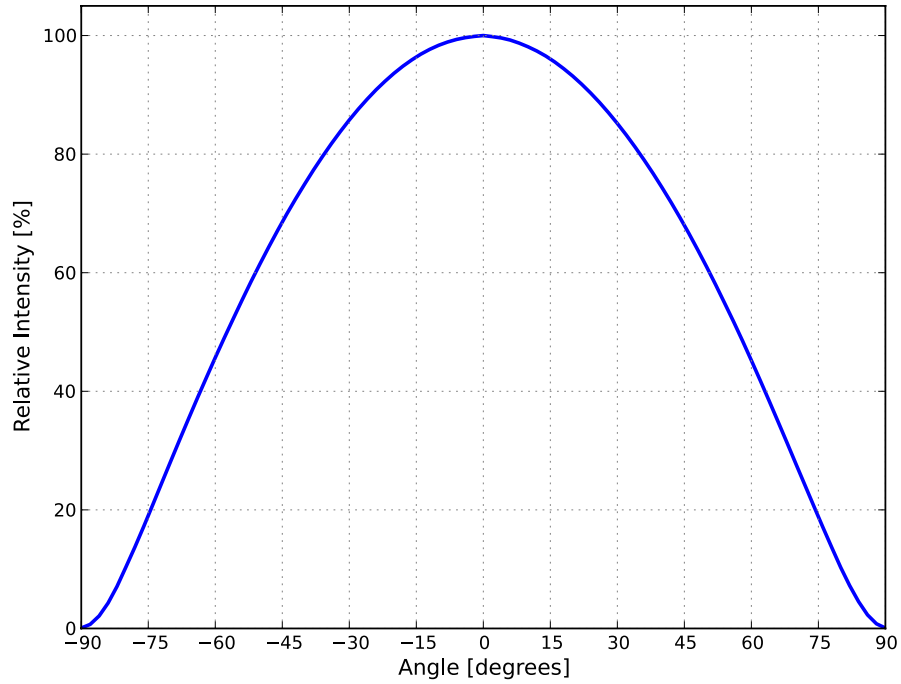

Figure 5. Typical radiation pattern for LUXEON CoB Core Pro at specified test current, $T_j=85^{\circ}\text{C}$.

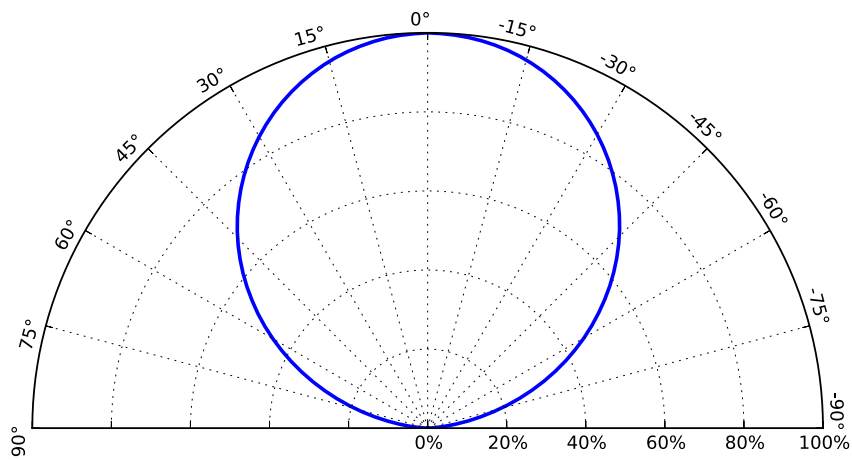

Figure 6. Typical polar radiation pattern for LUXEON CoB Core Pro at specified test current, $T_j=85^{\circ}\text{C}$.

Color Bin Definitions

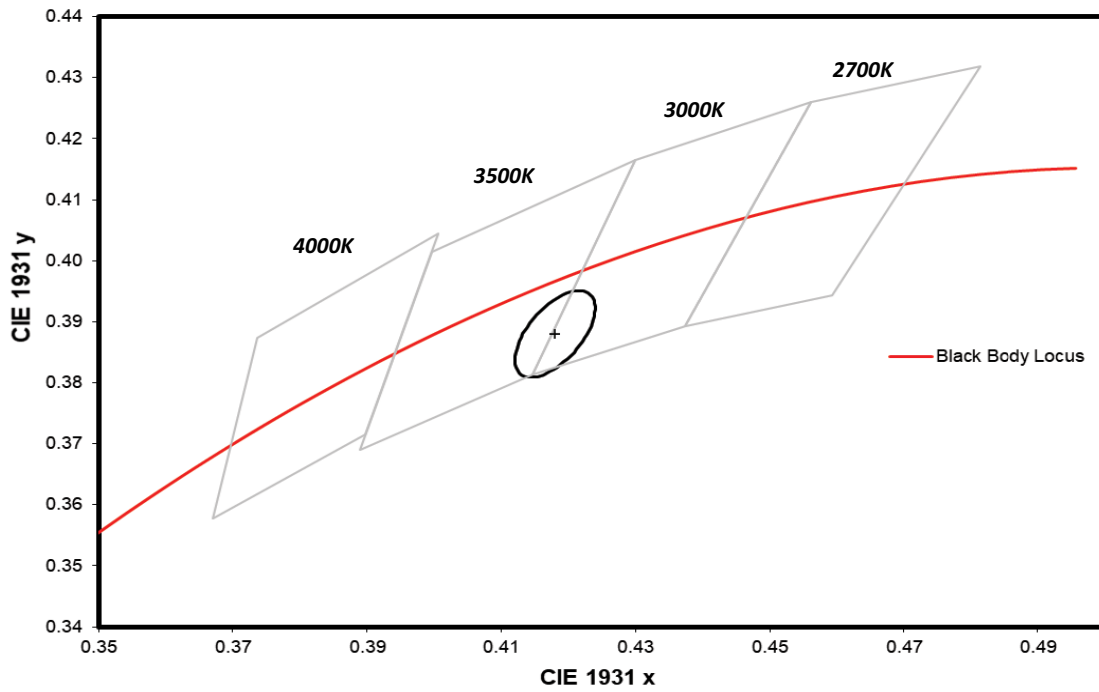

Figure 7. 3-step MacAdam ellipse illustration for Table 5.

Table 5. 3-step MacAdam ellipse color bin definitions for LUXEON CoB Core Pro.

NOMINAL CCT	COLOR SPACE	CENTER POINT ⁽¹⁾ (cx, cy)	MAJOR AXIS, a	MINOR AXIS, b	ELLIPSE ROTATION ANGLE, θ
3000K BBBL	Single 3-step MacAdam ellipse	(0.4180, 0.3880)	0.00834	0.00408	53.20°

Notes for Table 5:

1. Lumileds maintains a tolerance of ± 0.005 on x and y coordinates in the CIE 1931 color space.

Mechanical Dimensions

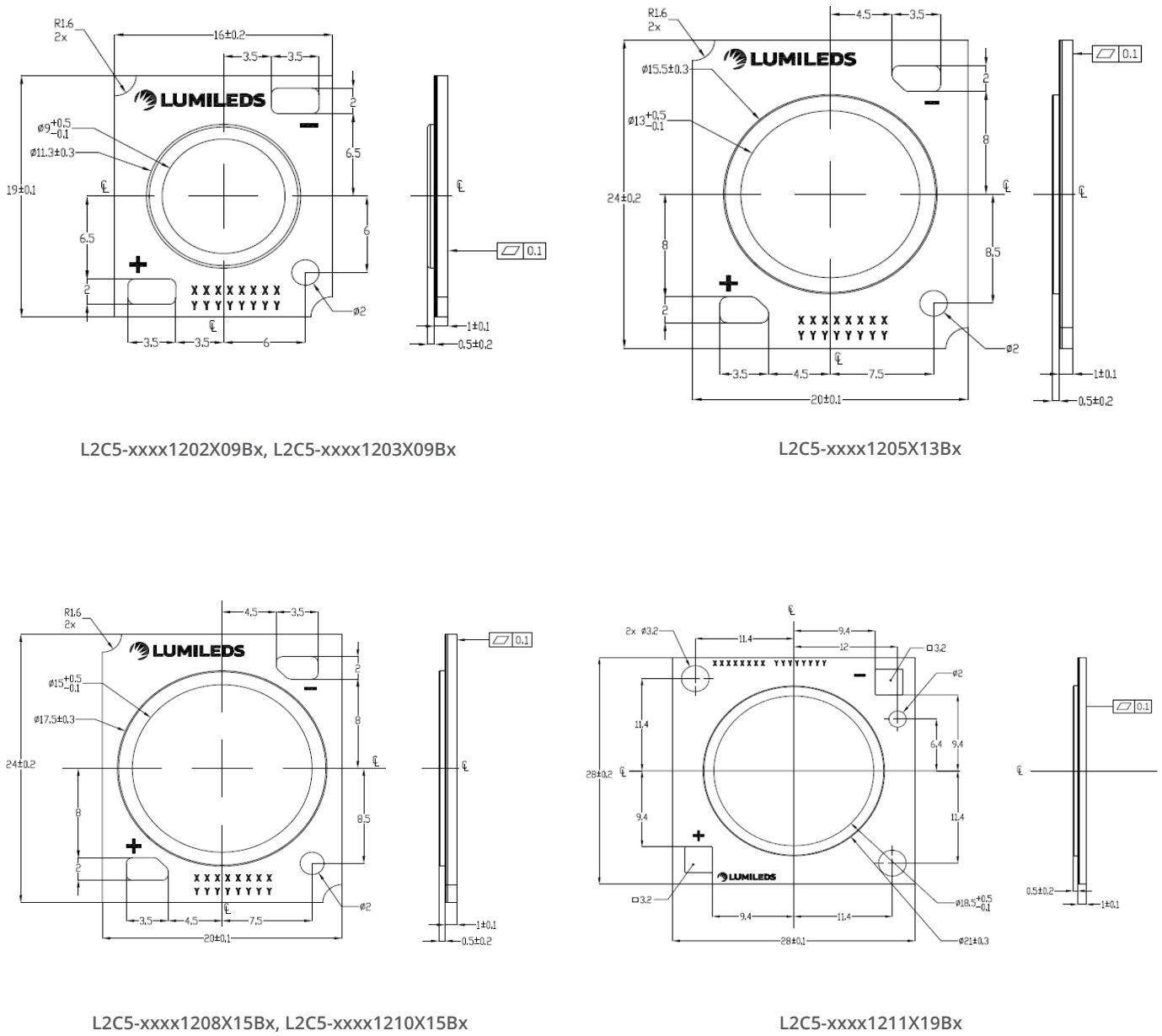

Figure 8. Mechanical dimensions for LUXEON CoB Core Pro.

Notes for Figure 8:

1. Drawings are not to scale.
2. All dimensions are in millimeters.

Packaging Information

LUXEON CoB Core Pro LEDs are packaged in tubes then in a carton box. Each tube contains a specified number of LEDs. The LEDs in each tube come from a single category code, ensuring they are all well-matched for light output, color, and forward voltage. Each tube contains a rubber stopper at one end. The tube label has both alphanumeric and bar code information. The carton boxes have printed information providing part numbers with CAT codes that indicate luminous flux, color and forward voltage bins.

Table 6. Number of LEDs per tube for LUXEON CoB Core Pro.

PART NUMBER	TOTAL UNITS PER TUBE	TOTAL TUBES PER INNER BOX	TOTAL UNITS PER INNER BOX
L2C5-xxxx1202X09Bx	20	5	100
L2C5-xxxx1203X09Bx	20	5	100
L2C5-xxxx1205X13Bx	20	5	100
L2C5-xxxx1208X15Bx	20	5	100
L2C5-xxxx1210X15Bx	20	5	100
L2C5-xxxx1211X19Bx	10	5	50

Tube Dimensions

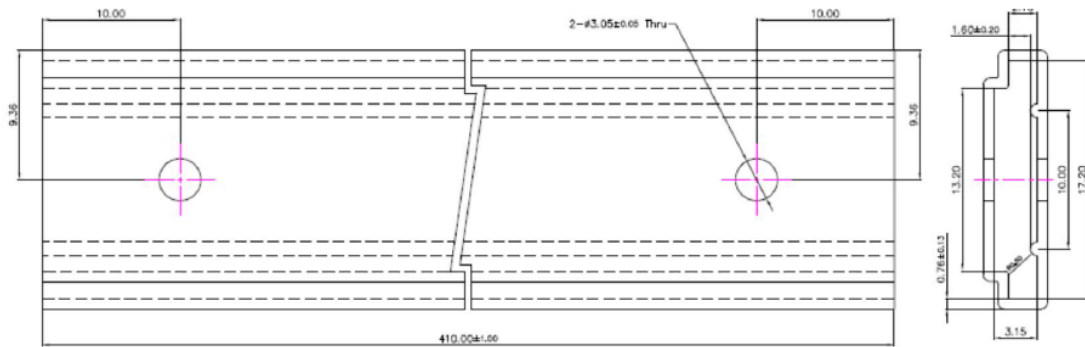

Figure 9a. Tube dimensions for L2C5-xxxx1202X09Bx, L2C5-xxxx1203X09Bx.

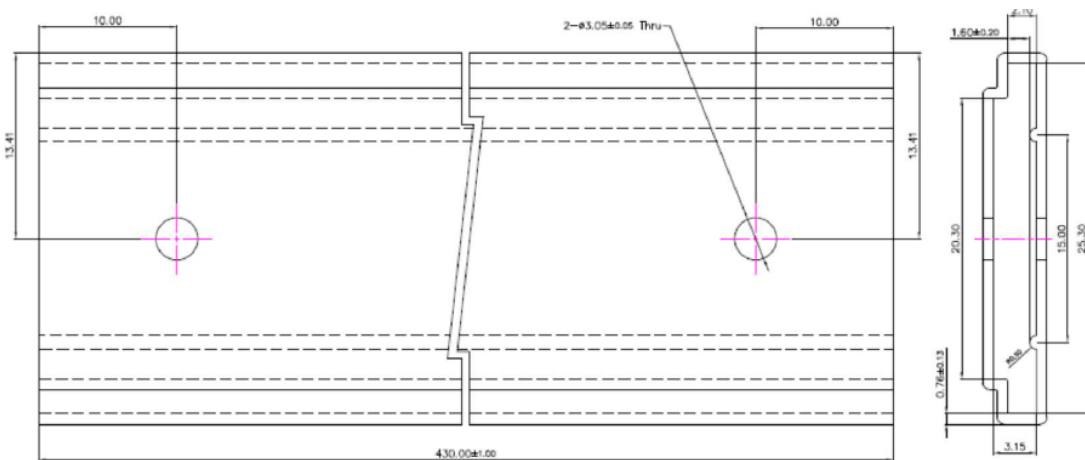

Figure 9b. Tube dimensions for L2C5-xxxx1205X13Bx, L2C5-xxxx1208X15Bx and L2C5-xxxx1210X15Bx.

Notes for Figures 9a and 9b:

1. Drawings not to scale.
2. All dimensions are in millimeters.

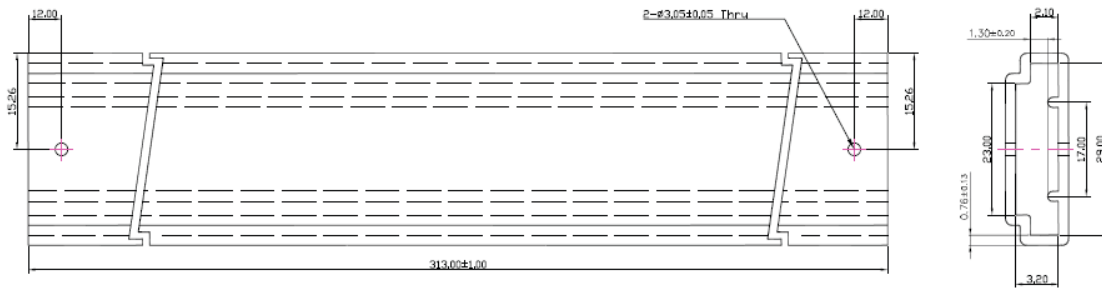

Figure 9c. Tube dimensions for L2C5-xxxx1211X19Bx.

Notes for Figure 9c:

1. Drawings not to scale.
2. All dimensions are in millimeters.

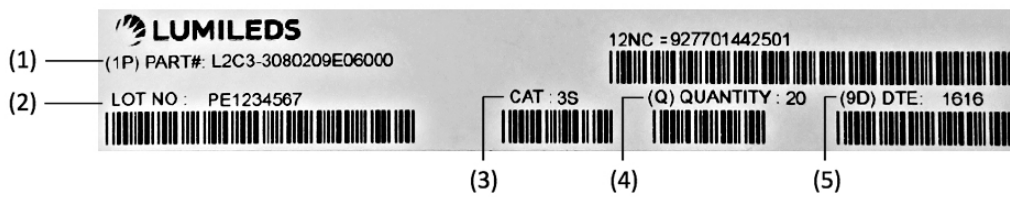

Figure 10. Example of a tube label for LUXEON CoB Core Pro.

Notes for Figure 10 - Tube Label descriptions for customer use:

Field labels not described are for Lumileds internal use only.

1. Lumileds part number.
2. Unique production lot identification number. This number is required for traceability purpose.
3. Product category code.
4. Number of LED emitters in a tube.
5. LED test date in YYWW format.

Inner Box

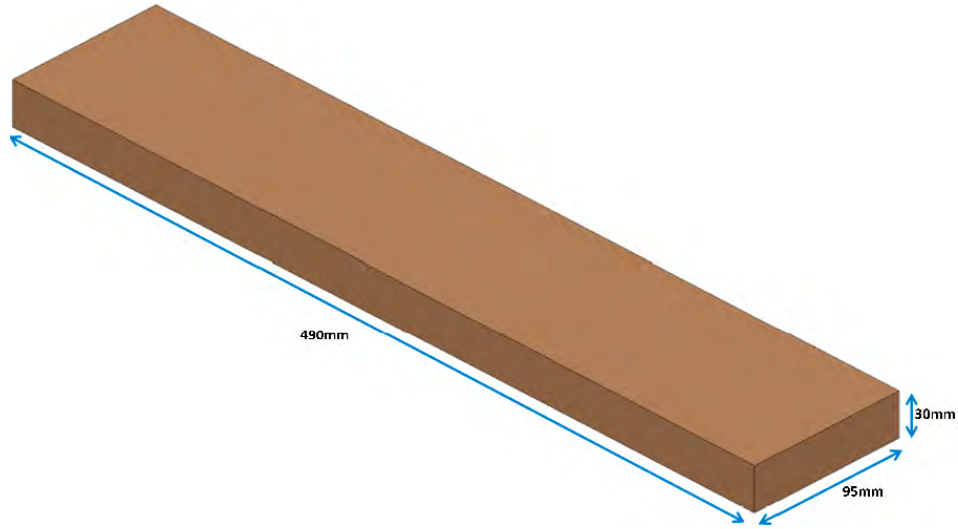

Figure 11. Dimensions for inner box packaging for LUXEON CoB Core Pro.

Table 7. Inner box information for LUXEON CoB Core Pro.

BOX TYPE	DIMENSIONS (mm)			AVERAGE WEIGHT (100pcs/box)	AVERAGE WEIGHT (50pcs/box)
	H	L	W		
Inner Box	30	490	95	0.340Kg	0.305Kg

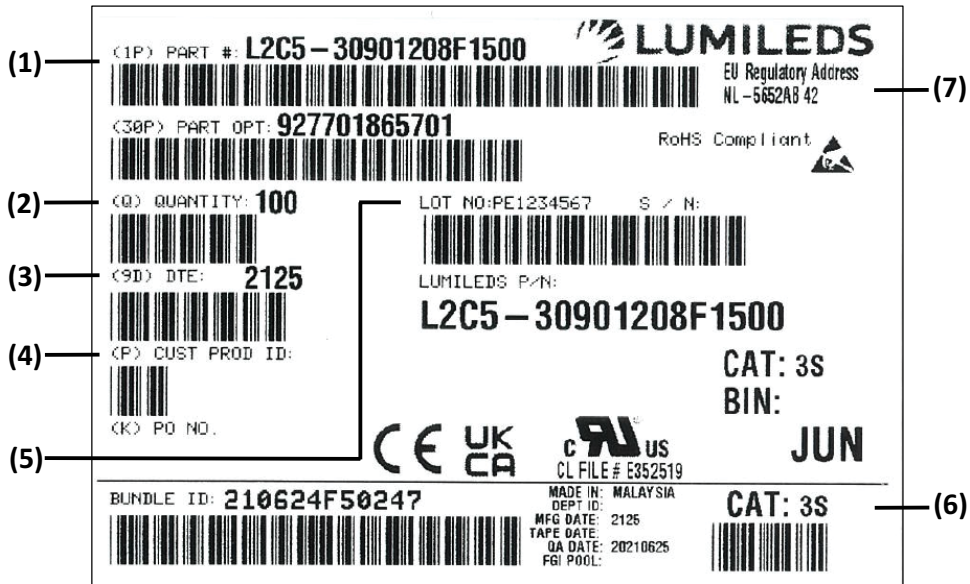

Figure 12. Example of inner box label for LUXEON CoB Core Pro.

Notes for Figure 12 – Inner Box Label descriptions for customer use:

Field labels not described are for Lumileds internal use only.

1. Lumileds part number.
2. Number of LED emitters in a box.
3. LED test date in YYWW format.
4. Customer part number for custom requests only.
5. Unique production lot identification number. This number is required for traceability purpose.
6. Product category code.
7. EU regulatory address.

Outer Box

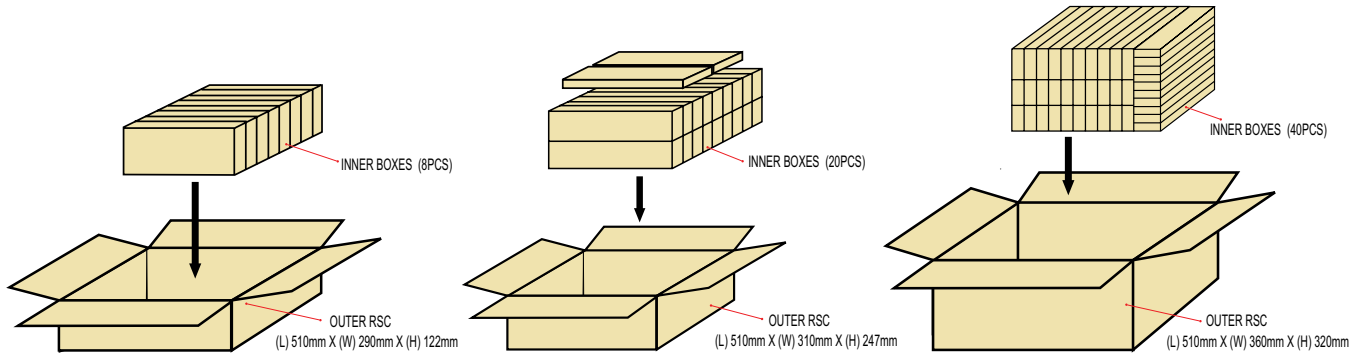

Figure 13. Dimensions for outer box packaging for LUXEON CoB Core Pro.

Table 8. Outer box information for LUXEON CoB Core Pro.

BOX TYPE	DIMENSIONS (mm)			MAXIMUM INNER BOXES PER OUTER BOX	MAXIMUM QUANTITY PER OUTER BOX	AVERAGE WEIGHT (100pcs/box)	AVERAGE WEIGHT (50pcs/box)
	H	L	W				
Outer Box 8	122	510	290	8	800	3.05kg	2.77kg
Outer Box 20	247	510	310	20	2000	7.55kg	6.85kg
Outer Box 40	320	510	360	40	4000	15.10kg	13.70kg

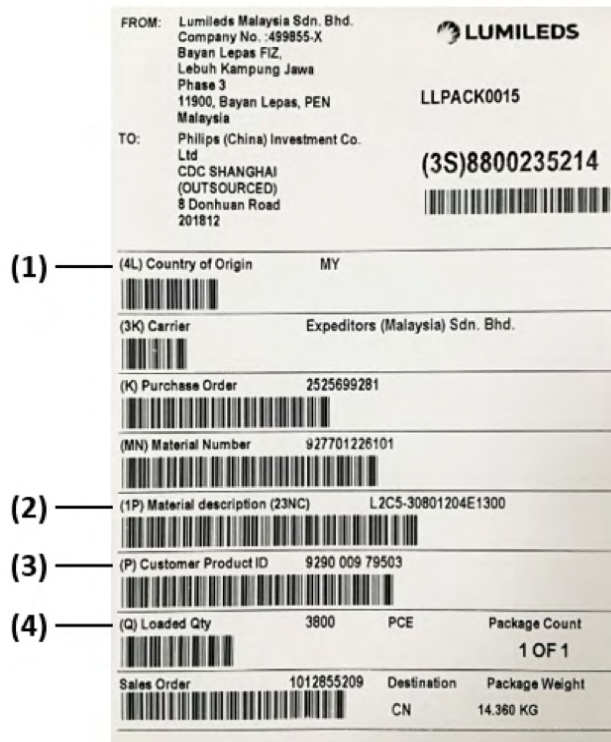

Figure 14. Example of outer box label for LUXEON CoB Core Pro.

Notes for Figure 14 – Outer Box Label descriptions for customer use:

Field labels not described are for Lumileds internal use only.

1. Country code of origin of manufacturing of parts (e.g. MY for Malaysia, CN for China) according to ISO 3166-1 alpha-2 document.
2. Lumileds part number.
3. Customer part number for custom requests only.
4. Total number of LED emitters in a shipment box.

About Lumileds

Companies developing automotive, mobile, IoT and illumination lighting applications need a partner who can collaborate with them to push the boundaries of light. With over 100 years of inventions and industry firsts, Lumileds is a global lighting solutions company that helps customers around the world deliver differentiated solutions to gain and maintain a competitive edge. As the inventor of Xenon technology, a pioneer in halogen lighting and the leader in high performance LEDs, Lumileds builds innovation, quality and reliability into its technology, products and every customer engagement. Together with its customers, Lumileds is making the world safer, better and more beautiful—with light.

To learn more about our lighting solutions, visit lumileds.com.



©2022 Lumileds Holding B.V. All rights reserved.
LUXEON is a registered trademark of the Lumileds Holding B.V. in the United States and other countries.
lumileds.com

Neither Lumileds Holding B.V. nor its affiliates shall be liable for any kind of loss of data or any other damages, direct, indirect or consequential, resulting from the use of the provided information and data. Although Lumileds Holding B.V. and/or its affiliates have attempted to provide the most accurate information and data, the materials and services information and data are provided "as is," and neither Lumileds Holding B.V. nor its affiliates warrants or guarantees the contents and correctness of the provided information and data. Lumileds Holding B.V. and its affiliates reserve the right to make changes without notice. You as user agree to this disclaimer and user agreement with the download or use of the provided materials, information and data. A listing of Lumileds product/patent coverage may be accessed at lumileds.com/patents.