



EC7BW SERIES 20 WATT 4:1 INPUT ISOLATED DC-DC CONVERTER

Features

- Efficiency up to 90%
- Fixed Switching Frequency
- Regulated Outputs
- Remote On/Off
- Fully Protected (OTP/OCP/OVP/UVLO)
- 1500Vdc I/O Isolation
- Operating Case Temperature -40 to +105°C
- 2"x1"x0.4" Size Meet Industrial Standard
- EN 50155 Compliant with External Circuits
- Shock & Vibration EN 50155 (EN 61373) Compliant
- Fire & Smoke EN 45545-2 Compliant
- 3000m Operating Altitude
- Safety Meets IEC/EN/UL 62368-1



MODEL NUMBER	INPUT VOLTAGE	OUTPUT VOLTAGE	OUTPUT CURRENT		INPUT CURRENT		% EFF. (1)	CAPACITOR LOAD MAX.
			MIN.	MAX.	NO LOAD	FULL LOAD		
EC7BW-24S33	9-36 VDC	3.3 VDC	0 mA	5500 mA	55 mA	869 mA	87	5500uF
EC7BW-24S05	9-36 VDC	5 VDC	0 mA	4000 mA	55 mA	926 mA	90	4000uF
EC7BW-24S12	9-36 VDC	12 VDC	0 mA	1670 mA	55 mA	928 mA	90	1800uF
EC7BW-24S15	9-36 VDC	15 VDC	0 mA	1330 mA	55 mA	924 mA	90	1500uF
EC7BW-24D05	9-36 VDC	±5 VDC	0 mA	±2000 mA	70 mA	937 mA	89	2000µF
EC7BW-24D12	9-36 VDC	±12 VDC	0 mA	±835 mA	35 mA	947 mA	88	1000µF
EC7BW-24D15	9-36 VDC	±15 VDC	0 mA	±666 mA	35 mA	947 mA	88	800µF
EC7BW-48S33	18-75 VDC	3.3 VDC	0 mA	5500 mA	25 mA	430 mA	88	5500uF
EC7BW-48S05	18-75 VDC	5 VDC	0 mA	4000 mA	25 mA	463 mA	90	4000uF
EC7BW-48S12	18-75 VDC	12 VDC	0 mA	1670 mA	25 mA	464 mA	90	1800uF
EC7BW-48S15	18-75 VDC	15 VDC	0 mA	1330 mA	25 mA	462 mA	90	1500uF
EC7BW-48D05	18-75 VDC	±5 VDC	0 mA	±2000 mA	35 mA	468 mA	89	2000µF
EC7BW-48D12	18-75 VDC	±12 VDC	0 mA	±835 mA	25 mA	474 mA	88	1000µF
EC7BW-48D15	18-75 VDC	±15 VDC	0 mA	±666 mA	25 mA	474 mA	88	800µF

NOTE:

1. Nominal Input Voltage 24, 48 VDC



EC7BW Series

PART NUMBER

Series	Nominal Input Voltage	Number of Outputs	Nominal Output Voltage	Remote On/Off Logic	PIN Configuration
EC7BW-	II	O	XX	L	-Y
EC7BW	24 : 24 VDC 48 : 48 VDC	S : Single D : Dual	33 : 3.3VDC 05 : 5VDC 12 : 12VDC 15 : 15VDC 05 : ±5VDC 12 : ±12VDC 15 : ±15VDC	None : Positive N : Negative	None : Standard S : Alternative Pin Configuration, Single output models only

Part Number Example:

EC7BW-24S12N: 2"x1", 20W, 4:1 9-36Vdc Input, Single 12Vdc Output, Negative Logic



TECHNICAL SPECIFICATIONS

(All specifications are typical at nominal input, full load at 25°C unless otherwise noted.)

ABSOLUTE MAXIMUM RATINGS

PARAMETER	NOTES and CONDITIONS	Device	Min.	Typ.	Max.	Units
Input Voltage	Continuous	24Vin 48Vin	-0.3		36 75	V _{dc}
Input Surge Voltage	100ms max.	24Vin 48Vin			50 100	V _{dc}
Operating Ambient Temperature	At the center part of case plate (with derating)	All	-40		85	°C
Maximum Case Temperature		All			105	°C
Storage Temperature		All	-55		125	°C

INPUT CHARACTERISTICS

PARAMETER	NOTES and CONDITIONS	Device	Min.	Typ.	Max.	Units
Operating Input Voltage		24Vin 48Vin	9 18	24 48	36 75	V _{dc}
Input Under Voltage Lockout						
Turn-On Voltage Threshold		24Vin 48Vin	8 16.5	8.5 17	8.8 17.5	V _{dc}
Turn-Off Voltage Threshold		24Vin 48Vin	7.7 15.5	8 16	8.3 16.5	V _{dc}
Lockout Hysteresis Voltage		24Vin 48Vin		0.6 0.9		V _{dc}
Maximum Input Current	V _{in} =9V, Full load V _{in} =18V, Full Load	24Vin 48Vin		2.61 1.305		A
No-Load Input Current	V _{in} =24, 48V, I _o =0A		See Model Number Table			mA
Input Filter	Pi filter.	All				
Inrush Current (I ² t)	As per ETS300 132-2	All			0.1	A ² s
Input Reflected Ripple Current	P-P thru 12uH inductor, 5Hz to 20MHz.	All		30		mA

OUTPUT CHARACTERISTICS

PARAMETER	NOTES and CONDITIONS	Device	Min.	Typ.	Max.	Units
Voltage Set Point Accuracy	V _{in} =24, 48V, Full load, T _c =25°C	All	-1.5		+1.5	%
Output Voltage Balance	V _{in} =24, 48V, Full load, T _c =25°C	Dual	-1.0		+1.0	%
Output Voltage Regulation						
Load Regulation	Full load to no load	All			±1.0	%
Line Regulation	V _{in} =High line to low line, full load	Single Dual			±0.2 ±0.5	%
Cross Regulation	Load cross variation 25%/100%	Dual			±5.0	%
Temperature Coefficient	T _c =-40°C to 85°C	All			±0.03	%/°C
Output Voltage Ripple and Noise (5Hz to 20MHz bandwidth)						
Peak-to-Peak	Full load, 0.1uF ceramic capacitors.	All			75	mV
Output Current Range	V _{in} = 24, 48V		See Model Number Table			A
Over Current Protection	Hiccup Mode. Auto recovery	All	110	125	150	%
Short Circuit Protection		All	Continuous, Auto Recovery			
External Load Capacitance	Full load (resistive)		See Model Number Table			uF
Output Voltage Trim Range	P _o ≤ max. rated power, I _o ≤ I _{o,max} .	Single	-10		+10	%



EC7BW Series

PARAMETER	NOTES and CONDITIONS	Device	Min.	Typ.	Max.	Units
Over Voltage Protection	Zener Clamp	3.3Vo		3.9		V _{dc}
		5Vo		6.2		
		12Vo		15		
		15Vo		18		
		±05Vo		±6.2		
		±12Vo		±15		
		±15Vo		±18		

EFFICIENCY

PARAMETER	NOTES and CONDITIONS	Device	Min.	Typ.	Max.	Units
100% Load	V _{in} =24, 48V	See Model Number Table				%

DYNAMIC CHARACTERISTICS

PARAMETER	NOTES and CONDITIONS	Device	Min.	Typ.	Max.	Units
Output Voltage Current Transient						
Error Band	75% to 100% of I _{o_max} . step load change di/dt=0.1A/us (within 1% V _{out} nominal)	All			±5	%
Recovery Time		All			500	us
Turn-On Delay and Rise Time	Full load (constant resistive load)					
Turn-On Delay Time, From On/Off Control	V _{on/off} to 10%V _{o_set} , Remote on	All		1.5		ms
Turn-On Delay Time, From Input	V _{in_min} . to 10%V _{o_set} , Power up	All		2.5		ms
Output Voltage Rise Time	10%V _{o_set} to 90%V _{o_set}	All		6		ms

ISOLATION CHARACTERISTICS

PARAMETER	NOTES and CONDITIONS	Device	Min.	Typ.	Max.	Units
Isolation Voltage (100% factory Hi-Pot tested @2sec.)	1 Minute; Input to output	All			1500	V _{dc}
Isolation Resistance	Input to output	All	100			MΩ
Isolation Capacitance	Input to output (10KHz, 0.25V)	All		1000		pF

FEATURE CHARACTERISTICS

PARAMETER	NOTES and CONDITIONS	Device	Min.	Typ.	Max.	Units
Switching Frequency	Output ripple frequency	Single		350		KHz
		Dual		400		
On/Off Control, Positive Remote On/Off Logic, Refer to -Vin Pin						
Logic Low (Module Off)	V _{on/off} at I _{on/off} =1.0mA	All	0		1.2	V
Logic High (Module On)	V _{on/off} at I _{on/off} =0.0uA, Pin open=On	All	5.5 or Open Circuit		75	V
On/Off Control, Negative Remote On/Off Logic, Refer to -Vin Pin						
Logic High (Module Off)	V _{on/off} at I _{on/off} =0.0uA, Pin open=Off	All	5.5 or Open Circuit		75	V
Logic Low (Module On)	V _{on/off} at I _{on/off} =1.0mA	All	0		1.2	V
On/Off Current (for both remote on/off logic)	I _{on/off} at V _{on/off} =0V	All		0.3	1	mA
Leakage Current (for both remote on/off logic)	Logic high, V _{on/off} =15V	All			30	uA
Off Converter Input Current	Shutdown input idle current	All		4	10	mA



EC7BW Series

GENERAL SPECIFICATIONS

PARAMETER	NOTES and CONDITIONS	Device	Min.	Typ.	Max.	Units
MTBF	$I_o=100\%$ of I_{o_max} ; MIL-HDBK - 217F_Notice 1, GB, 25°C	All		720		K hours
Weight		All		35		grams
Case Material	Black Coated Copper					
Base plate Material	FR4					
Potting Material	UL 94V-0					
Pin Material	Base: Copper Plating: Nickel with Matte Tin					
Shock/Vibration	MIL-STD-810F/EN 61373 Compliant					
Humidity	95% RH max. Non Condensing					
Altitude	3000m Operating Altitude, 12000m Transport Altitude					
Thermal Shock	MIL-STD-810F					
Fire & Smoke	EN 45545-2 Compliant					

EMC SPECIFICATIONS (External components required, please refer to application note.)

EMI	EN 55032 & EN50155 Compliant (with external filter)			Class A
ESD	EN 61000-4-2	Level 3: Air $\pm 8kV$, Contact $\pm 6kV$		Perf. Criteria A
Radiated Immunity	EN 61000-4-3	Level 3: 80~1000MHz, 20V/m		Perf. Criteria A
Fast Transient	EN 61000-4-4	Level 3: On power input port, $\pm 2kV$, external components required (EN 50155)		Perf. Criteria A
Surge	EN 61000-4-5	Level 3: Line to earth, $\pm 2kV$, Line to line, $\pm 1kV$ (EN 50155), external components required		Perf. Criteria A
Conducted Immunity	EN 61000-4-6	Level 3: 0.15~80MHz, 10V		Perf. Criteria A
Interruptions of Voltage Supply	EN 50155	Class S3: 20ms interruptions		Perf. Criteria A
Supply Change Over	EN 50155	Class C2: During a supply break of 30ms		Perf. Criteria A
Application Note Link				EC7BW Series App Notes
Packaging Information Link				Packaging Information



EC7BW Series

Immunity to Environmental Conditions

Phenomenon	EN50155; 2017 Reference Clause(s)	Reference Standard	Test Conditions	Result
Low Temperature Start-up test	13.4.4	EN 60068-2-1	Class OT4 Temperature: -40°C Duration: 2 hrs	Pass
Dry Heat Test	13.4.5	EN 60068-2-2	Class OT4 & Cycle B Temperature: 70°C Duration: 6 hrs Extended temperature: 85°C Extended Duration: 10min	Pass
Low Temperature Storage Test	13.4.6	EN 60068-2-1	Temperature: -40°C Duration: 16 hrs	Pass
Cyclic Damp Heat Test	13.4.7	EN 60068-2-30	Temperature: 25°C - 55°C Humidity: 90% RH Duration: 48 hrs	Pass
Random Vibration Test	13.4.11	EN 61373	Temperature: 25°C +/- 10°C Humidity: 50% +/-25% RH Frequency range: 5 ~ 150 Hz Vertical: 0.98 m/s^2 Transverse: 0.44 m/s^2 Longitudinal: 0.69 m/s^2 Duration: 10 min / axis	Pass
Simulated Long Life Test at Increased Random Vibration Levels	13.4.11	EN 61373	Temperature: 25°C +/-10°C Humidity: 50% +/-25% RH Frequency range: 5 ~ 150 Hz Vertical: 5.72 m/s^2 Transverse: 2.5 m/s^2 Longitudinal: 3.96 m/s^2 Duration: 5 hrs / axis	Pass
Shock Test	13.4.11	EN 61373	Temperature: 25°C +/-10°C Humidity: 50% +/-25% RH Frequency range: 5 ~ 150 Hz +/-Vertical: 30 m/s^2 +/-Transverse: 30 m/s^2 +/-Longitudinal: 50 m/s^2 Duration: 30ms x18 (Each axis 3 shocks)	Pass

EN45545-2 Fire & Smoke Test Conditions

Item		Standard	Hazard Level
R22	Oxygen Index Test	EN 45545-2: 2013 EN ISO 4589-2: 2006	HL1, HL2, HL3
	Smoke Density Test	EN 45545-2: 2013 EN ISO 5659-2: 2013	HL1, HL2, HL3
	Smoke Toxicity Test	EN 45545-2: 2013 NF X70-100: 2006	HL1, HL2, HL3
R23	Oxygen Index Test	EN 45545-2: 2013 EN ISO 4589-2: 2006	HL1, HL2, HL3
	Smoke Density Test	EN 45545-2: 2013 EN ISO 5659-2: 2013	HL1, HL2, HL3
	Smoke Toxicity Test	EN 45545-2: 2013 NF X70-100: 2006	HL1, HL2, HL3
R24	Oxygen Index Test	EN45545-2: 2013 EN ISO 4589-2	HL1, HL2, HL3
R25	Glow - Wire Test	EN 45545-2:2013 EN 60695-2-11:2001	HL1, HL2, HL3
R26	Vertical Flame Test	EN 45545-2: 2013 EN 60695-11-10: 2013	HL1, HL2, HL3



CHARACTERISTIC CURVE

Power Derating Curve

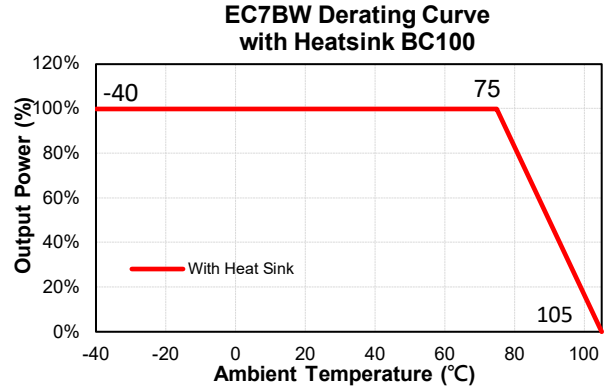
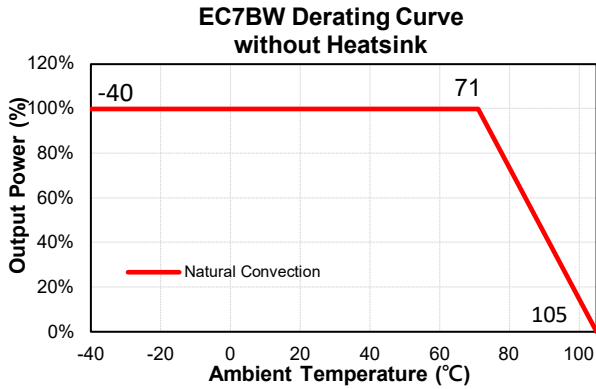

Performance Data

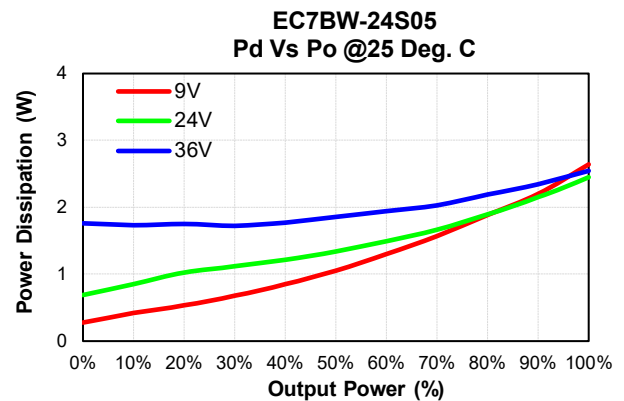
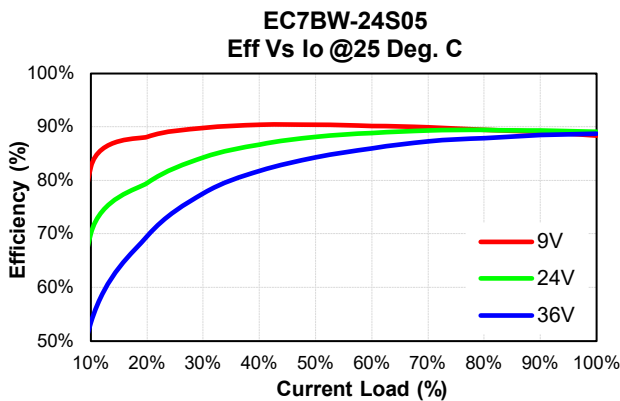
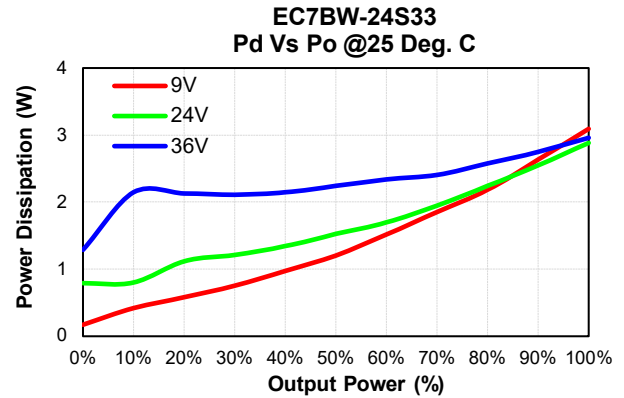
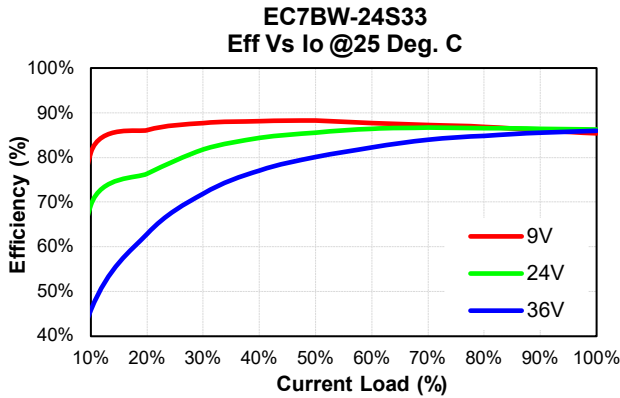



EC7BW Series

EC7BW-24S12
Eff Vs Io @25 Deg. C

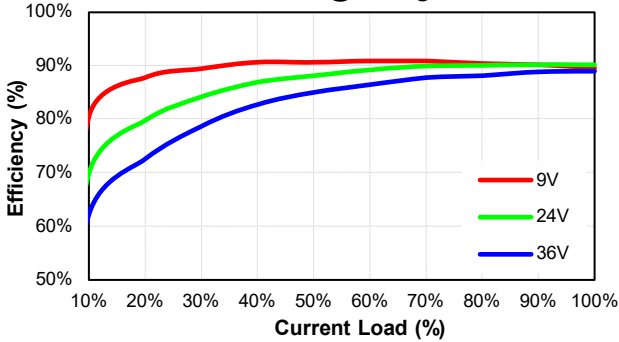

EC7BW-24S12
Pd Vs Po @25 Deg. C

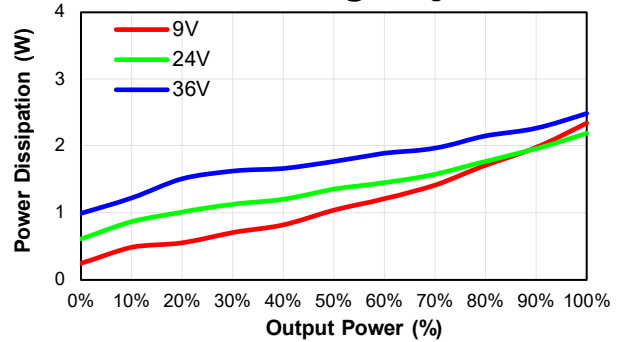

EC7BW-24S15
Eff Vs Io @25 Deg. C

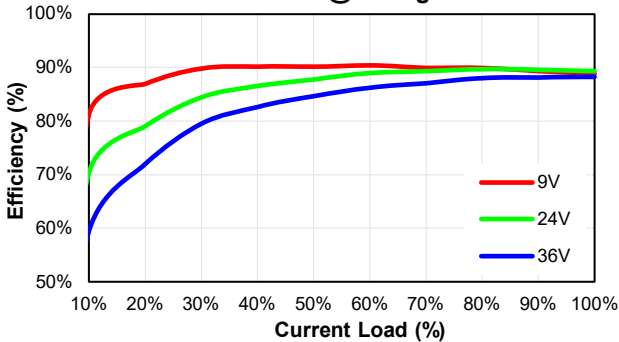

EC7BW-24S15
Pd Vs Po @25 Deg. C

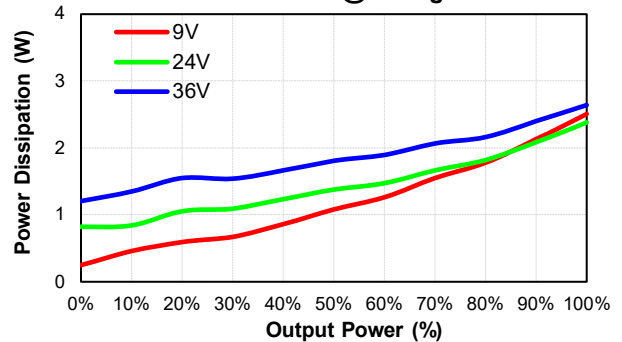

EC7BW-24D05
Eff Vs Io @25 Deg. C

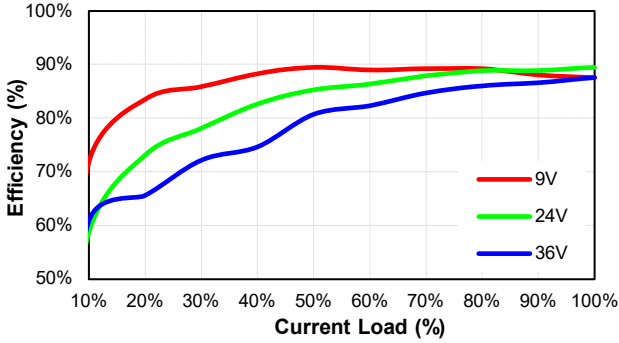

EC7BW-24D05
Pd Vs Po @25 Deg. C

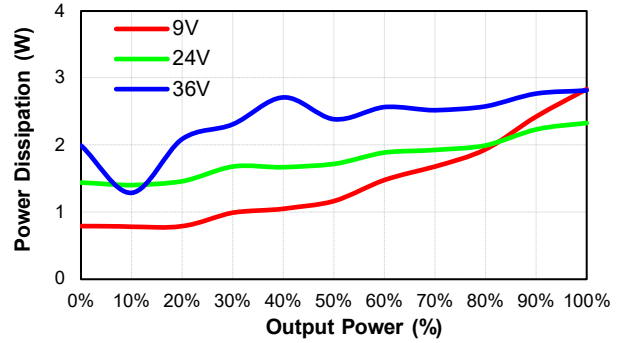

EC7BW-24D12
Eff Vs Io @25 Deg. C

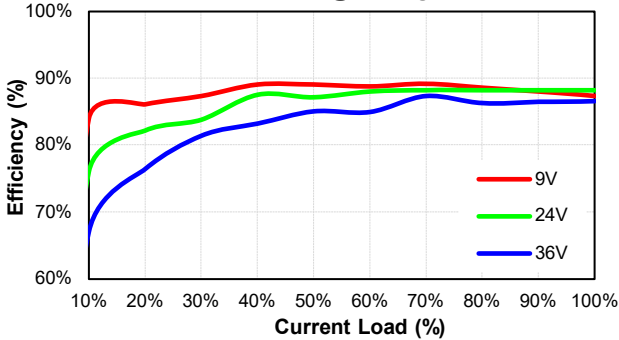

EC7BW-24D12
Pd Vs Po @25 Deg. C

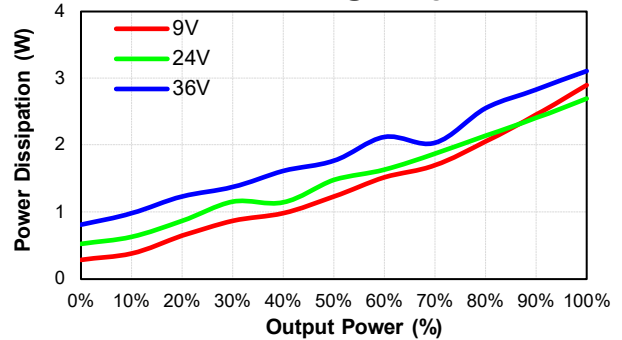



EC7BW Series

EC7BW-24D15
Eff Vs Io @25 Deg. C

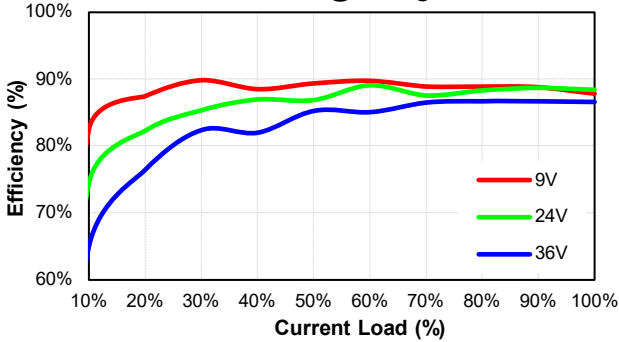

EC7BW-24D15
Pd Vs Po @25 Deg. C

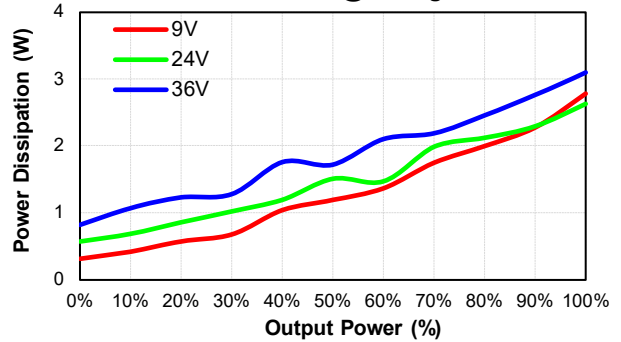

EC7BW-48S33
Eff Vs Io @25 Deg. C

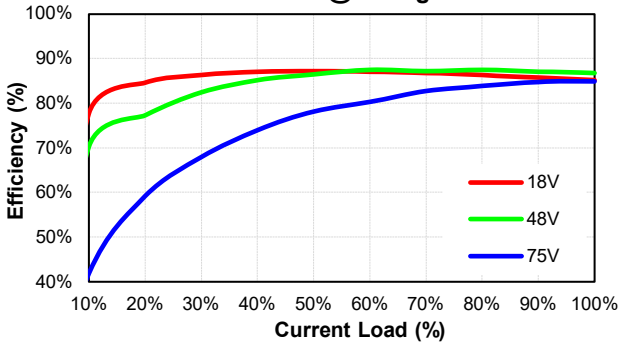

EC7BW-48S33
Pd Vs Po @25 Deg. C

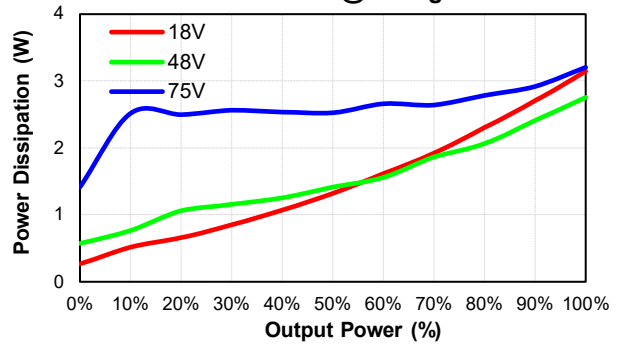

EC7BW-48S05
Eff Vs Io @25 Deg. C

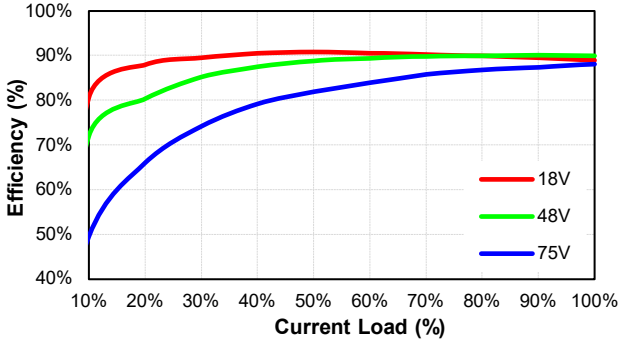

EC7BW-48S05
Pd Vs Po @25 Deg. C

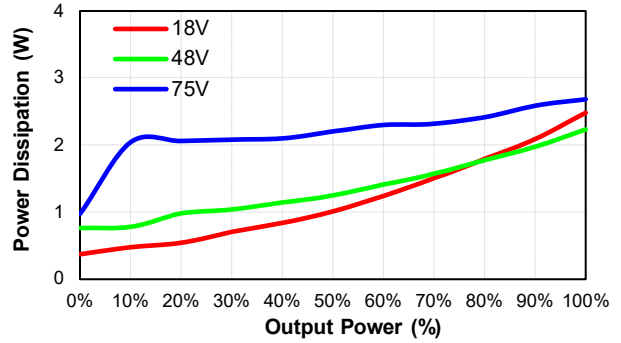

EC7BW-48S12
Eff Vs Io @25 Deg. C

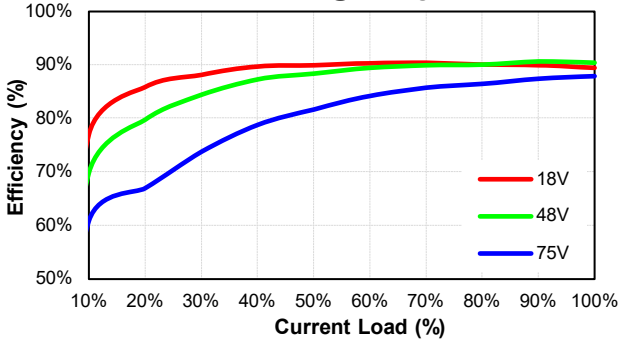

EC7BW-48S12
Pd Vs Po @25 Deg. C

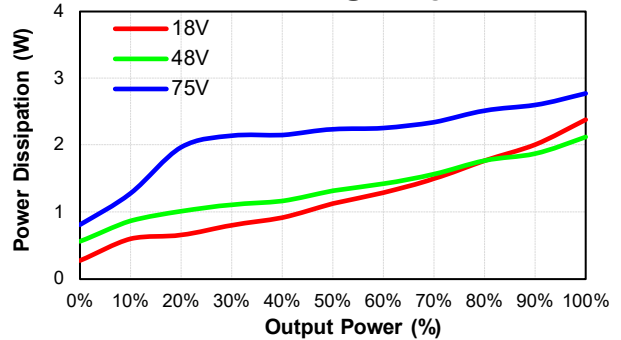



EC7BW Series

EC7BW-48S15
Eff Vs Io @25 Deg. C

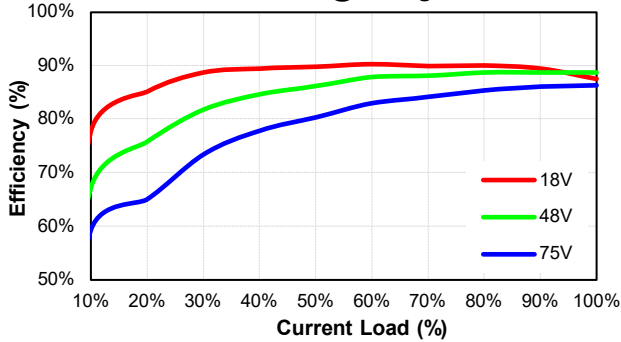

EC7BW-48S15
Pd Vs Po @25 Deg. C

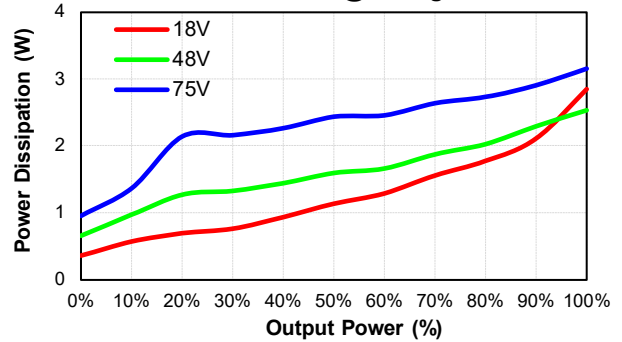

EC7BW-48D05
Eff Vs Io @25 Deg. C

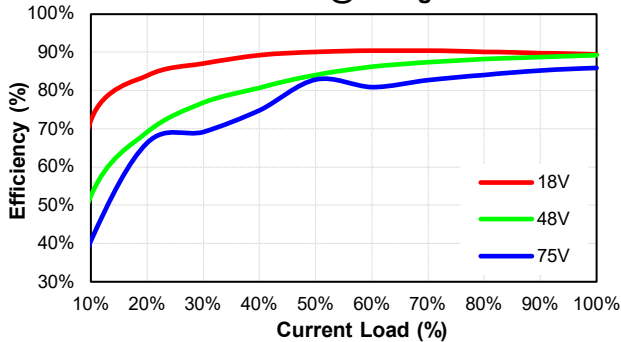

EC7BW-48D05
Pd Vs Po @25 Deg. C

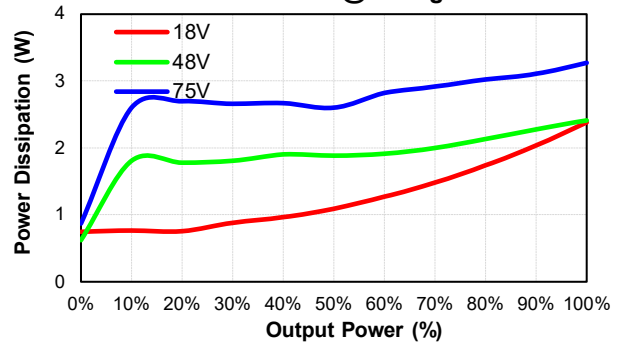

EC7BW-48D12
Eff Vs Io @25 Deg. C

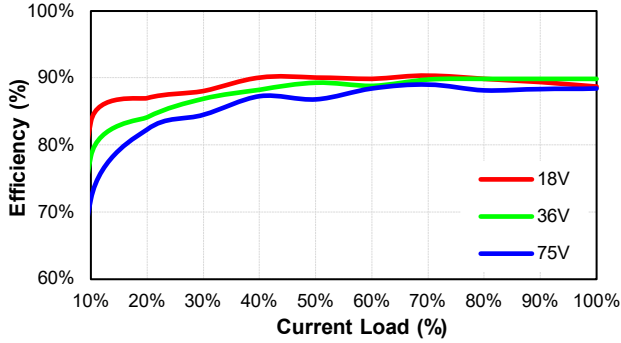

EC7BW-48D12
Pd Vs Po @25 Deg. C

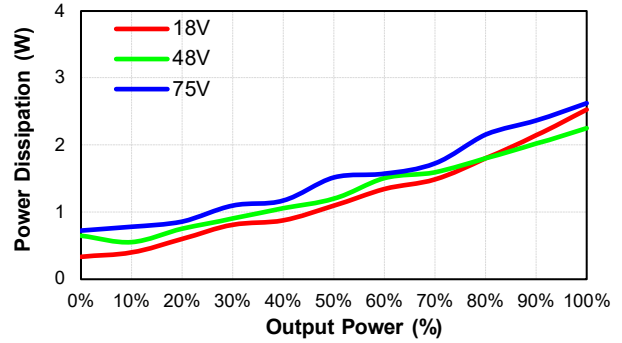

EC7BW-48D15
Eff Vs Io @25 Deg. C

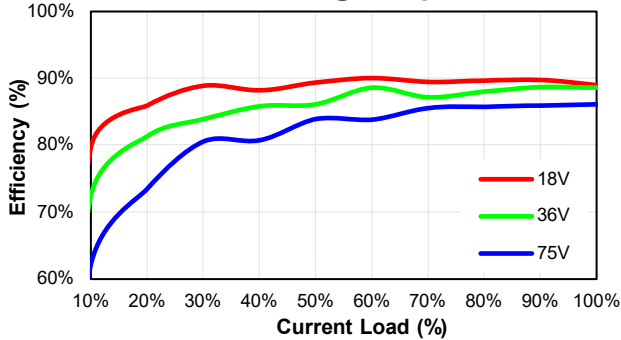

EC7BW-48D15
Pd Vs Po @25 Deg. C

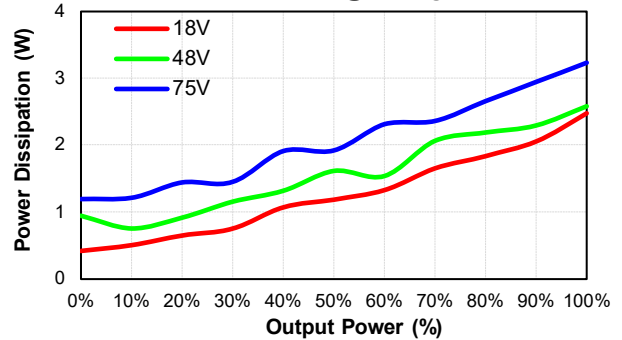



MECHANICAL SPECIFICATION

All Dimensions In Inches (mm)
 Tolerances Inches .XX= ±.04 , .XXX= ±.010
 Millimeters .XX= ±1.0 , .XXX= ±0.25

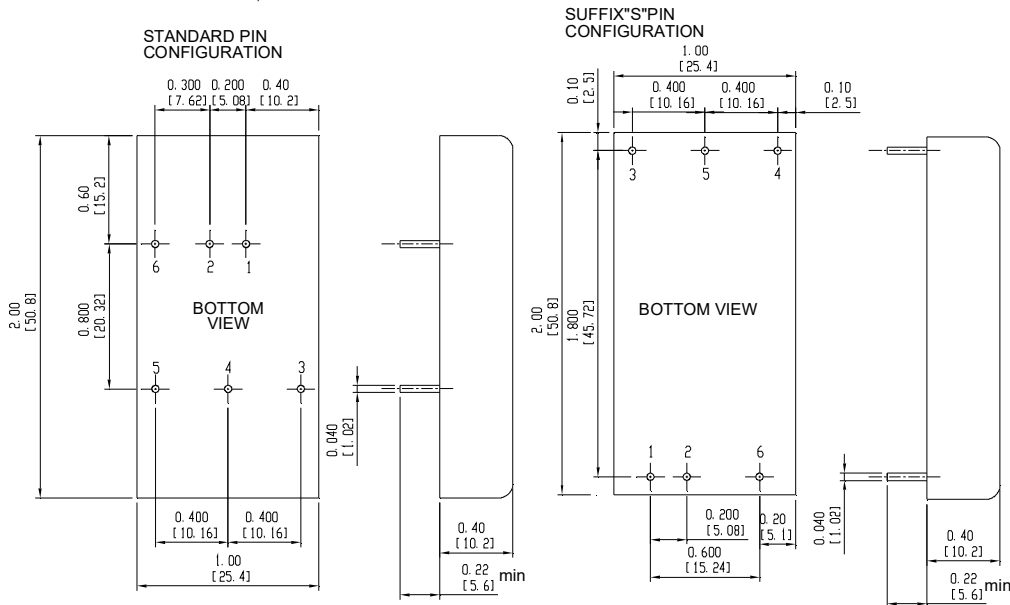

PIN CONNECTION		
Pin	Single	Dual
1	+Vin	+Vin
2	-Vin	-Vin
3	+Vout	+Vout
4	Trim	Common
5	-Vout	-Vout
6	Remote ON/OFF	

CINCON Electronics Co. Ltd.
 Add: 14F, No. 306, Sec.4, Hsin Yi Rd., Taipei, Taiwan
 Tel: 886-2-27086210
 Fax: 886-2-27029852
 E-mail: sales@cincon.com.tw
 Web: www.cincon.com