

MAXIM**400MHz, Ultra-Low-Distortion Op Amps****General Description**

The MAX4108/MAX4109/MAX4308/MAX4309 op amps combine ultra-high-speed performance with ultra-low-distortion operation. The MAX4108 is compensated for unity-gain stability; the MAX4109, MAX4308, and MAX4309 are compensated for minimum closed-loop gains (A_{VCL}) of 2V/V, 5V/V, and 10V/V, respectively.

The MAX4108 delivers a 400MHz unity-gain bandwidth with a 1200V/ μ s slew rate. An ultra-low-distortion design provides an unprecedented spurious-free dynamic range of -93dBc (MAX4108) at 5MHz ($V_{OUT} = 2V_{p-p}$, $R_L = 100\Omega$), making these amplifiers ideal for high-performance RF signal processing.

These high-speed op amps feature a wide output voltage swing and a high-current output-drive capability of 90mA.

Applications

High-Speed ADC/DAC Preamp
 RGB and Composite Video
 High-Performance Receivers
 Pulse/RF Amplifier
 Active Filters
 Ultrasound
 Broadcast and High-Definition TV

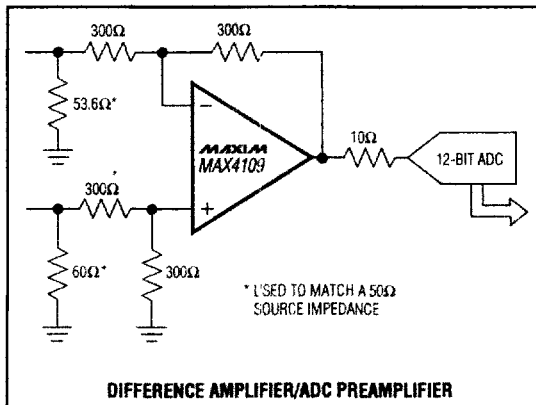
Typical Application Circuit**Features**

- ◆ **High Speed:**
 - 400MHz Unity-Gain Bandwidth (MAX4108)
 - 225MHz -3dB Bandwidth ($A_{VCL} = +2$, MAX4109)
 - 220MHz -3dB Bandwidth ($A_{VCL} = +5$, MAX4308)
 - 200MHz -3dB Bandwidth ($A_{VCL} = +10$, MAX4309)
- ◆ **1200V/ μ s Slew Rate**
- ◆ **Excellent Spurious-Free Dynamic Range:**
 - 93dBc at $f_c = 5$ MHz (MAX4108)
 - 90dBc at $f_c = 5$ MHz (MAX4109)
- ◆ **100MHz 0.1dB Gain Flatness (MAX4108)**
- ◆ **High Full-Power Bandwidth: 300MHz (MAX4108, $V_O = 2V_{p-p}$)**
- ◆ **High Output Drive: 90mA**
- ◆ **Output Short-Circuit Protected**
- ◆ **Low Differential Gain/Phase: 0.004%/0.008°**

Ordering Information

PART	TEMP. RANGE	PIN-PACKAGE
MAX4108ESA	-40°C to +85°C	8 SO
MAX4109ESA	-40°C to +85°C	8 SO
MAX4308ESA	-40°C to +85°C	8 SO
MAX4309ESA	-40°C to +85°C	8 SO

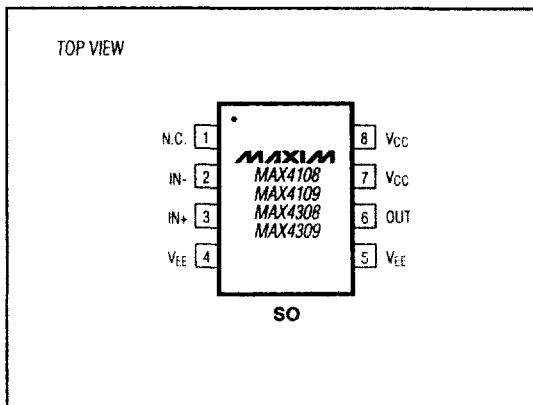
Pin Configuration**MAX4108/MAX4109/MAX4308/MAX4309****MAXIM**

Maxim Integrated Products 8-117

For free samples & the latest literature: <http://www.maxim-ic.com>, or phone 1-800-998-8800
 For small orders, phone 408-737-7600 ext. 3468.

400MHz, Ultra-Low-Distortion Op Amps

MAX4108/MAX4109/MAX4308/MAX4309

ABSOLUTE MAXIMUM RATINGS

Supply Voltage (VCC to VEE).....	12V	Operating Temperature Range	-40°C to +85°C
Voltage on Any Pin to Ground or Any Other Pin	(VEE - 0.3V) to (VCC + 0.3V)	Storage Temperature Range	-65°C to +150°C
Short-Circuit Duration (OUT to GND).....	Continuous	Junction Temperature	+150°C
Continuous Power Dissipation (TA = +70°C) SO (derate 5.88mW/°C above +70°C).....	471mW	Lead Temperature (soldering, 10sec)	+300°C

Stresses beyond those listed under "Absolute Maximum Ratings" may cause permanent damage to the device. These are stress ratings only, and functional operation of the device at these or any other conditions beyond those indicated in the operational sections of the specifications is not implied. Exposure to absolute maximum rating conditions for extended periods may affect device reliability.

ELECTRICAL CHARACTERISTICS

(VCC = +5V, VEE = -5V, TA = TMIN to TMAX, typical values are at TA = +25°C, unless otherwise noted.)

PARAMETER	SYMBOL	CONDITIONS	MIN	TYP	MAX	UNITS
DC SPECIFICATIONS (RL = ∞)						
Input Offset Voltage	VOS	VOUT = 0V		1	8	mV
Input Offset Voltage Drift	TCVOS	VOUT = 0V		13		µV/°C
Input Bias Current	IB	VOUT = 0V, VIN = -VOS		12	34	µA
Input Offset Current	IOS	VOUT = 0V, VIN = -VOS		0.05	2.5	µA
Common-Mode Input Resistance	RINCM	Either input		1.5		MΩ
Common-Mode Input Capacitance	CINCM	Either input		1		pF
Input Voltage Noise	en	f = 10kHz		6		nV/√Hz
Integrated Voltage Noise	EnRMS	fB = 1MHz to 100MHz		75		µVRMS
Input Current Noise	in	f = 10kHz		2		pA/√Hz
Integrated Current Noise	In	fB = 1MHz to 100MHz		25		nARMS
Common-Mode Input Voltage	VCM		-2.5		2.5	V
Common-Mode Rejection	CMR	VCM = ±2.5V	70	100		dB
Power-Supply Rejection	PSR	VS = ±4.5V to ±5.5V	70	90		dB
Open-Loop Voltage Gain	AOL	VOUT = ±2.0V, VCM = 0V, RL = 100Ω	70	100		dB
Quiescent Supply Current	IS	VIN = 0V		20	27	mA
Output Voltage Swing	VOUT	RL = ∞	2.5 to -3.1	2.9 to -3.8		V
		RL = 100Ω	2.5 to -3.1	2.7 to -3.7		
Output Current Drive	IOUT	RL = 33Ω, TA = 0°C to +85°C	65	90		mA
Short-Circuit Output Current	ISC	Short to ground		100		mA
AC SPECIFICATIONS (RL = 100Ω)						
-3dB Bandwidth	BW-3dB	VOUT ≤ 0.1VRMS	MAX4108	400		MHz
			MAX4109	225		
			MAX4308	220		
			MAX4309	200		

400MHz, Ultra-Low-Distortion Op Amps

ELECTRICAL CHARACTERISTICS (continued)

(V_{CC} = +5V, V_{EE} = -5V, T_A = T_{MIN} to T_{MAX}, typical values are at T_A = +25°C, unless otherwise noted.)

PARAMETER	SYMBOL	CONDITIONS	MIN	TYP	MAX	UNITS
AC SPECIFICATIONS (R_L = 100Ω) (continued)						
Full-Power Bandwidth	FPBW	V _{OUT} = 2V _{p-p}	MAX4108	300		MHz
			MAX4109	200		
			MAX4308	190		
			MAX4309	130		
0.1dB Gain Flatness	BW _{0.1dB}	MAX4108, A _{vCL} = +1		100		MHz
		MAX4109, A _{vCL} = +2		25		
		MAX4308, A _{vCL} = +5		100		
		MAX4309, A _{vCL} = +10		30		
Slew Rate	SR	-2V ≤ V _{OUT} ≤ 2V		1200		V/μs
Settling Time	t _s	-1V ≤ V _{OUT} ≤ 1V	To 0.1%	8		ns
			To 0.01%	12		
Rise/Fall Times	t _r , t _f	10% to 90%	-2V ≤ V _{OUT} ≤ 2V	3		ns
			-50mV ≤ V _{OUT} ≤ 50mV	2		
Differential Gain	DG	f = 3.58MHz, R _L = 150Ω		0.004		%
Differential Phase	DP	f = 3.58MHz, R _L = 150Ω		0.008		degrees
Input Capacitance	C _{IN}			2		pF
Output Resistance	R _{OUT}	f = 10MHz		1		Ω
Spurious-Free Dynamic Range	SFDR	MAX4108, V _{OUT} = 2V _{p-p} , A _{vCL} = +1	f _c = 5MHz, R _L = 100Ω	-93		dBc
			f _c = 20MHz, R _L = 100Ω	-81		
		MAX4109, V _{OUT} = 2V _{p-p} , A _{vCL} = +2	f _c = 5MHz, R _L = 100Ω	-90		
			f _c = 20MHz, R _L = 100Ω	-80		
		MAX4308, V _{OUT} = 2V _{p-p} , A _{vCL} = +5	f _c = 5MHz, R _L = 100Ω	-83		
			f _c = 20MHz, R _L = 100Ω	-80		
		MAX4309, V _{OUT} = 2V _{p-p} , A _{vCL} = +10	f _c = 5MHz, R _L = 100Ω	-83		
			f _c = 20MHz, R _L = 100Ω	-80		
Third-Order Intercept	IP3	f _c = 10MHz	MAX4108	39		dBm
			MAX4109	36		
			MAX4308	46		
			MAX4309	43		

MAX4108/MAX4109/MAX4308/MAX4309

400MHz, Ultra-Low-Distortion Op Amps

Typical Operating Characteristics

($V_{CC} = +5V$, $V_{EE} = -5V$, $R_L = 100\Omega$, $T_A = +25^\circ C$, unless otherwise noted.)

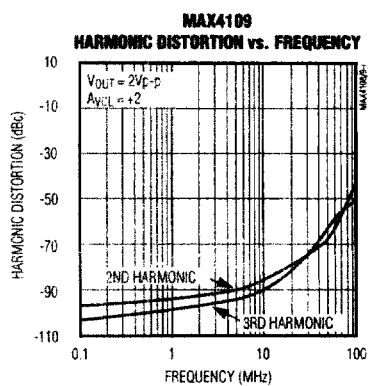
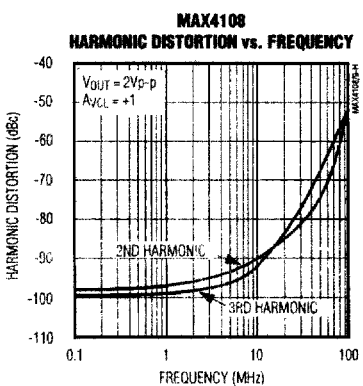
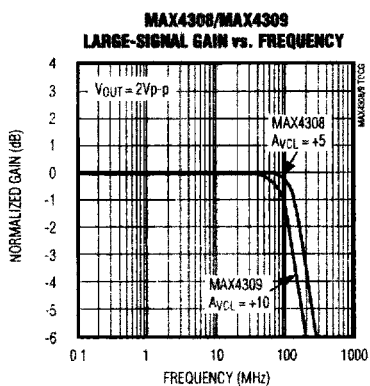
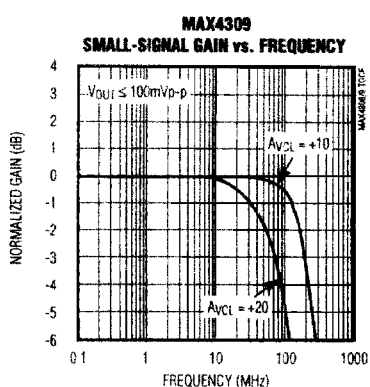
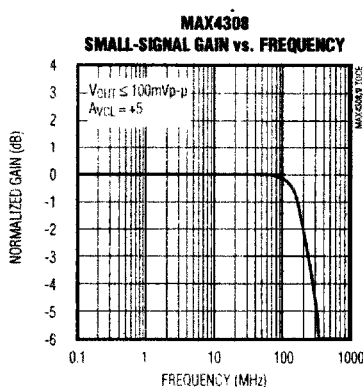
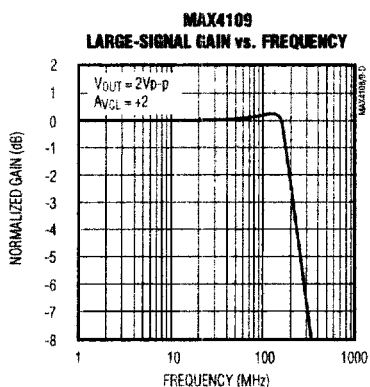
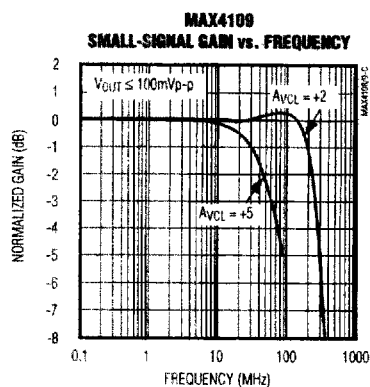
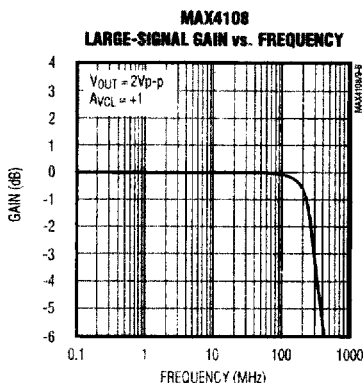
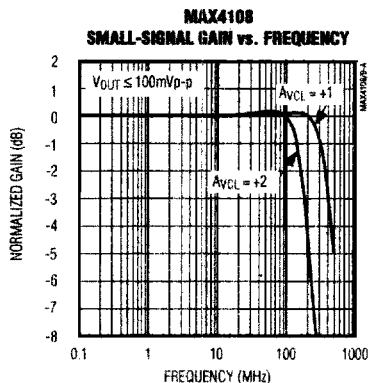

MAX4108/MAX4109/MAX4308/MAX4309

400MHz, Ultra-Low-Distortion Op Amps

Typical Operating Characteristics (continued)

($V_{CC} = +5V$, $V_{EE} = -5V$, $R_L = 100\Omega$, $T_A = +25^\circ C$, unless otherwise noted.)

MAX4108/MAX4109/MAX4308/MAX4309

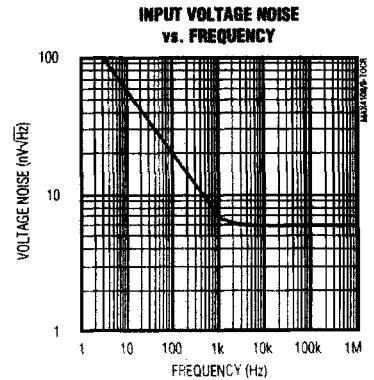
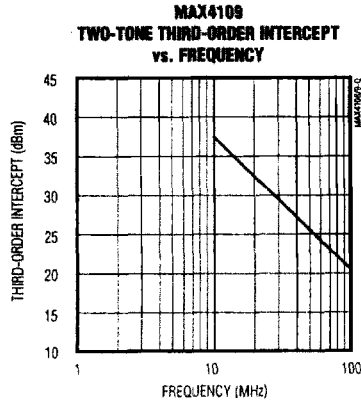
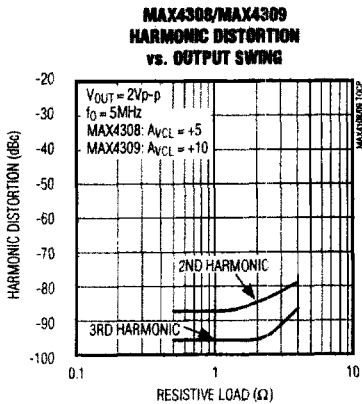
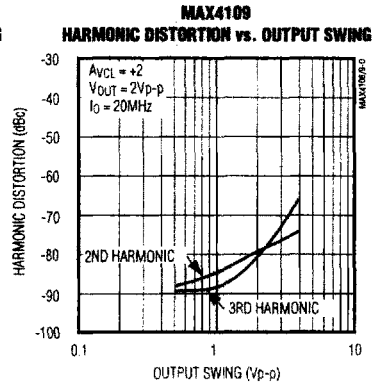
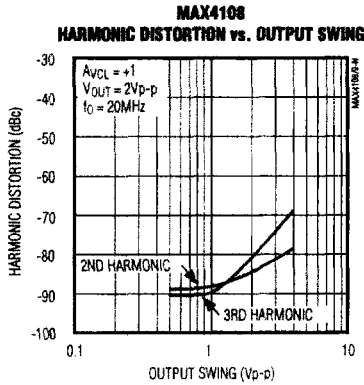
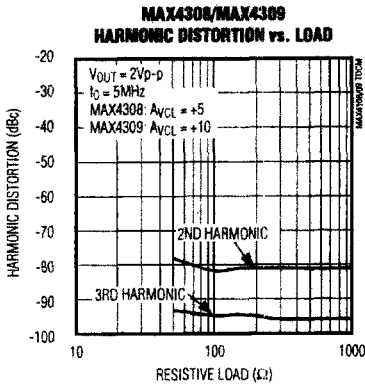
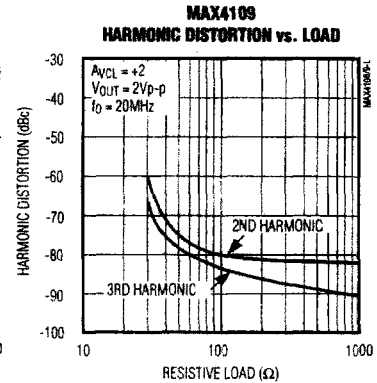
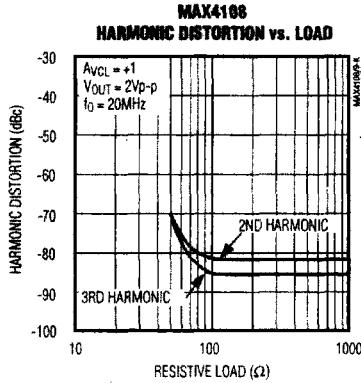
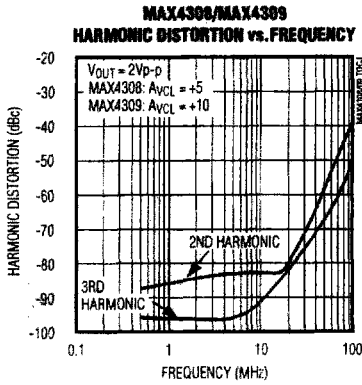

400MHz, Ultra-Low-Distortion Op Amps

Typical Operating Characteristics (continued)

(V_{CC} = +5V, V_{EE} = -5V, R_L = 100Ω, T_A = +25°C, unless otherwise noted.)

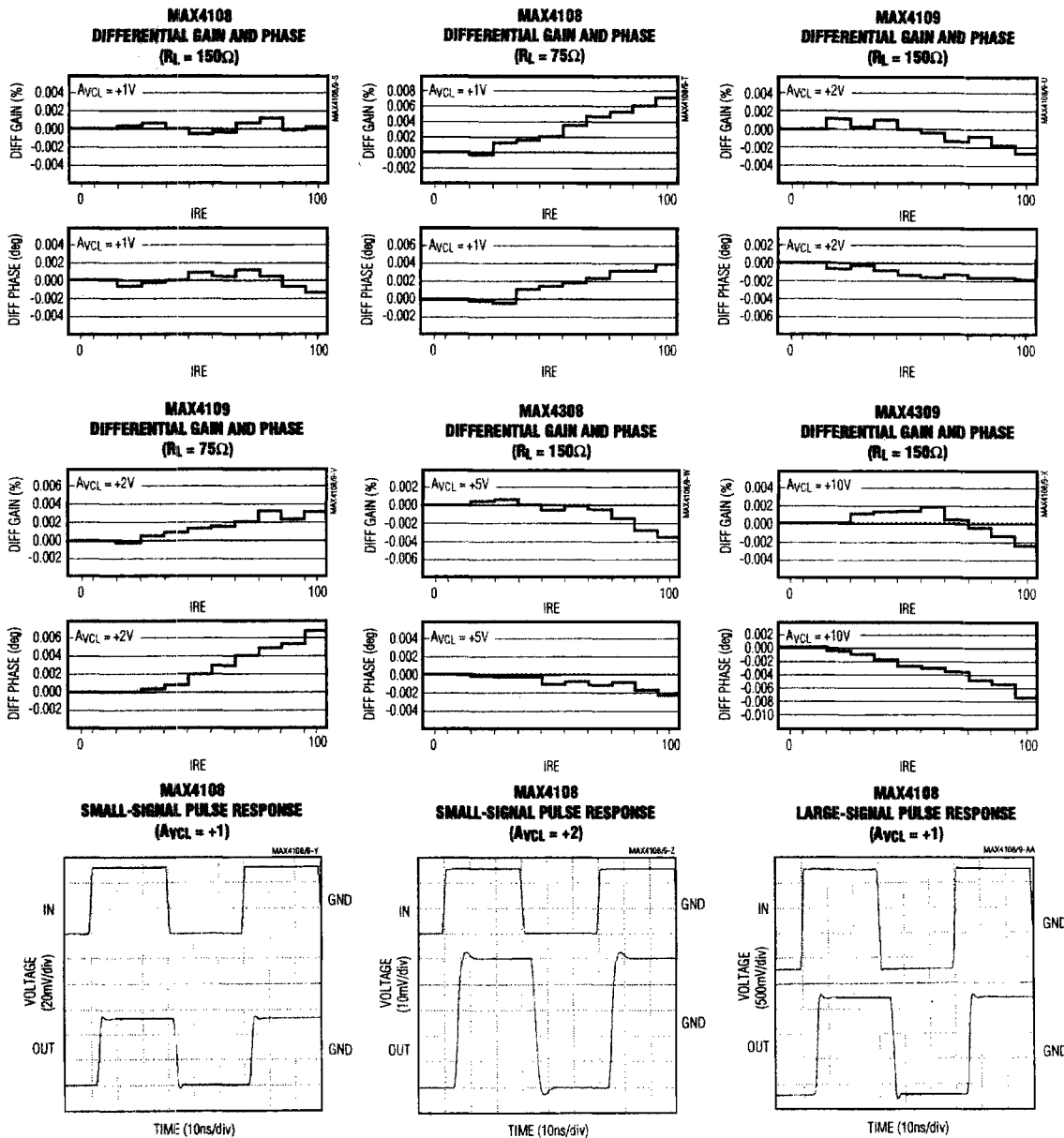

400MHz, Ultra-Low-Distortion Op Amps

Typical Operating Characteristics (continued)

($V_{CC} = +5V$, $V_{EE} = -5V$, $R_L = 100\Omega$, $T_A = +25^\circ C$, unless otherwise noted.)

MAX4108/MAX4109/MAX4308/MAX4309

MAX4108
LARGE-SIGNAL PULSE RESPONSE
($A_{vCL} = +2$)

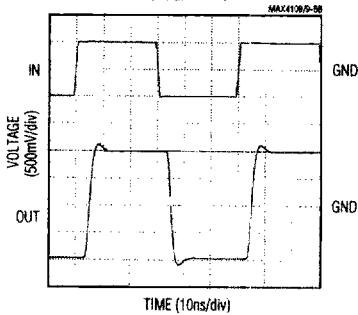

MAX4109
SMALL-SIGNAL PULSE RESPONSE
($A_{vCL} = +2$)

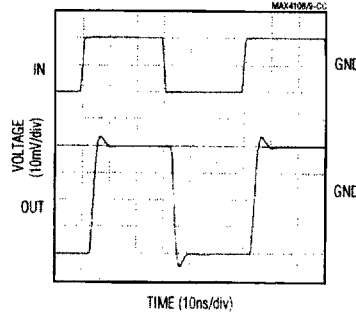

MAX4109
LARGE-SIGNAL PULSE RESPONSE
($A_{vCL} = +2$)

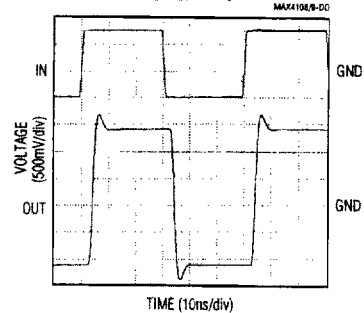

MAX4308
SMALL-SIGNAL PULSE RESPONSE
($A_{vCL} = +5$)

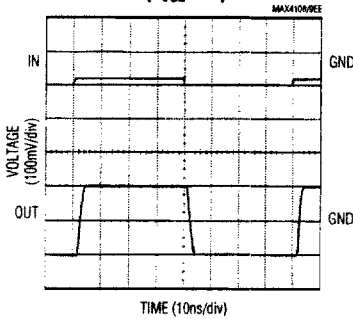

MAX4308
LARGE-SIGNAL PULSE RESPONSE
($A_{vCL} = +5$)

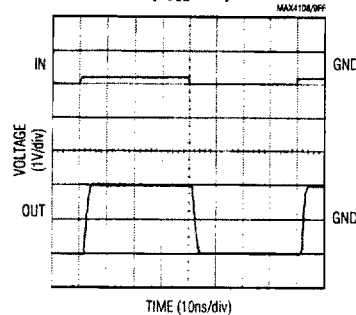

MAX4309
SMALL-SIGNAL PULSE RESPONSE
($A_{vCL} = +10$)

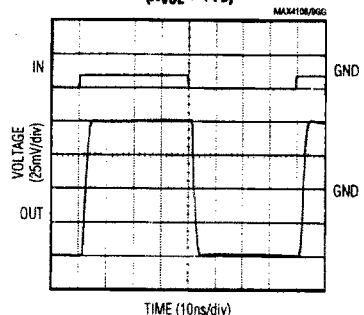

MAX4309
SMALL-SIGNAL PULSE RESPONSE
($A_{vCL} = +20$)

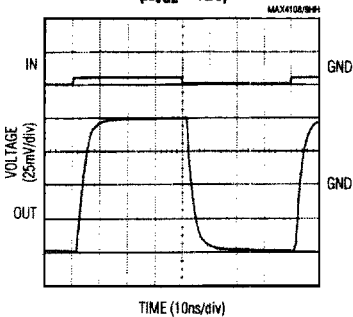

MAX4309
LARGE-SIGNAL PULSE RESPONSE
($A_{vCL} = +10$)

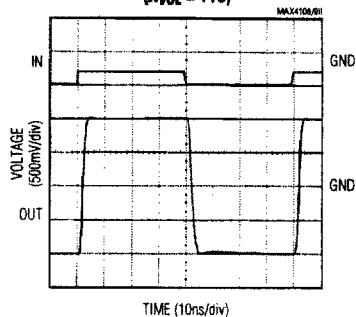

MAX4309
LARGE-SIGNAL PULSE RESPONSE
($A_{vCL} = +20$)

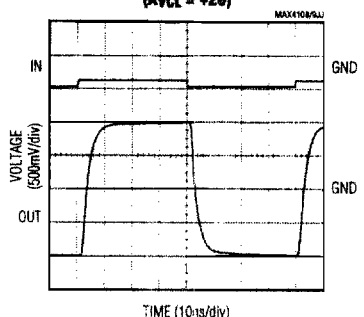

400MHz, Ultra-Low-Distortion Op Amps

Typical Operating Characteristics (continued)

($V_{CC} = +5V$, $V_{EE} = -5V$, $R_L = 100\Omega$, $T_A = +25^\circ C$, unless otherwise noted.)

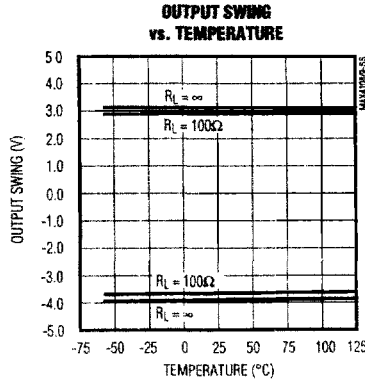
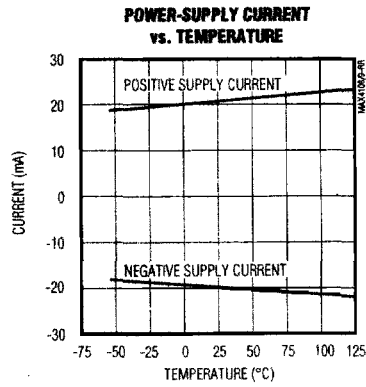
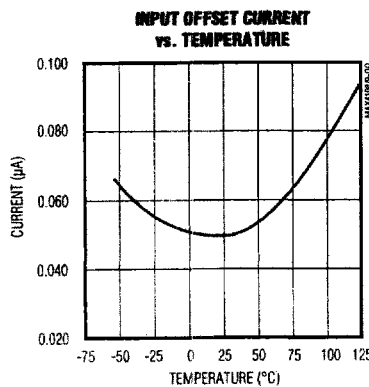
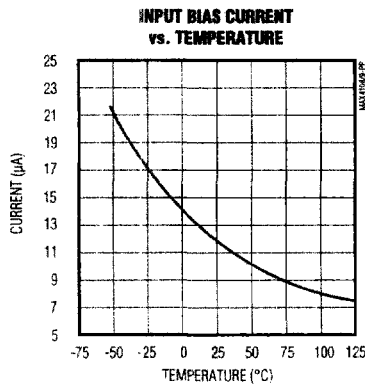
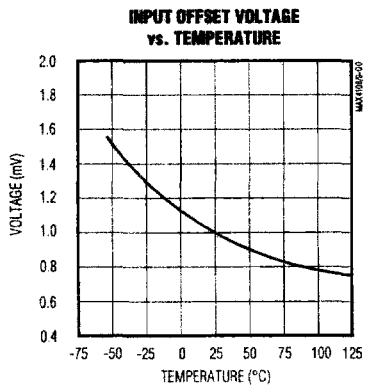
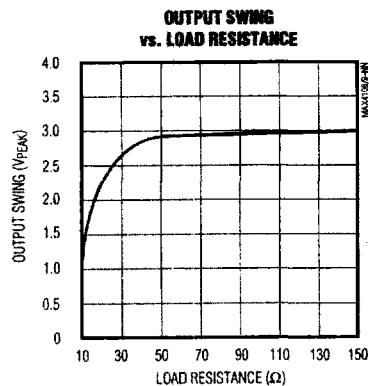
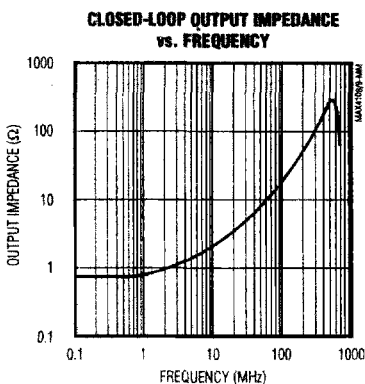
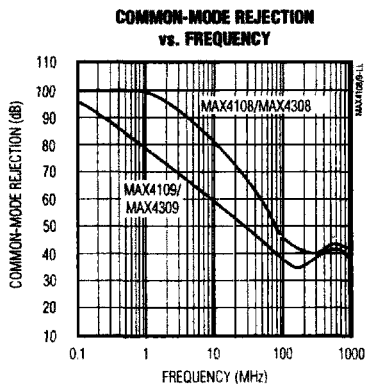
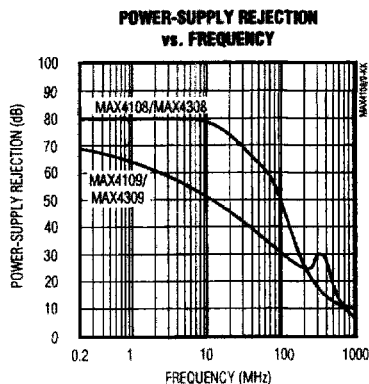

400MHz, Ultra-Low-Distortion Op Amps

Pin Description

PIN	NAME	FUNCTION
1	N.C.	No Connection. Not internally connected.
2	IN-	Inverting Input
3	IN+	Noninverting Input
4, 5	VEE	Negative Power Supply, connect to -5VDC.
6	OUT	Amplifier Output
7, 8	VCC	Positive Power Supply, connect to +5VDC.

Detailed Description

Choosing Resistor Values

Unity-Gain Configuration

The MAX4108 is internally compensated for unity gain. When configured for unity gain, the device requires a small resistor in series with the feedback path. This resistor improves the AC response by reducing the Q of the tank circuit, which is formed by parasitic feedback inductance and capacitance.

Inverting and Noninverting Configurations

The values of the gain-setting feedback and input resistors are important design considerations. Large resistor values will increase voltage noise, and will interact with the amplifier's input and PC board capacitance to generate undesirable poles and zeros, which can decrease bandwidth or cause oscillations. For example, a noninverting gain of +2, using 1k Ω resistors combined with 2pF of input capacitance and 0.5pF of board capacitance, will cause a feedback pole at 128MHz. If this pole is within the anticipated amplifier bandwidth, it will jeopardize stability. Reducing these 1k Ω resistors to 100 Ω will extend the pole frequency to 1.28GHz, but could limit output swing by adding 200 Ω in parallel with the amplifier's load. Clearly, the selection of resistor values must be tailored to the specific application.

The MAX4108/MAX4109/MAX4308/MAX4309 are ultra-low-distortion, high-bandwidth op amps. The output distortion will be degraded as the total load resistance seen by the amplifier decreases. To minimize distortion products, keep the input and gain-setting resistors relatively large. A 500 Ω feedback resistor combined with an appropriate input resistor to set the gain will provide excellent AC performance without significantly increasing distortion.

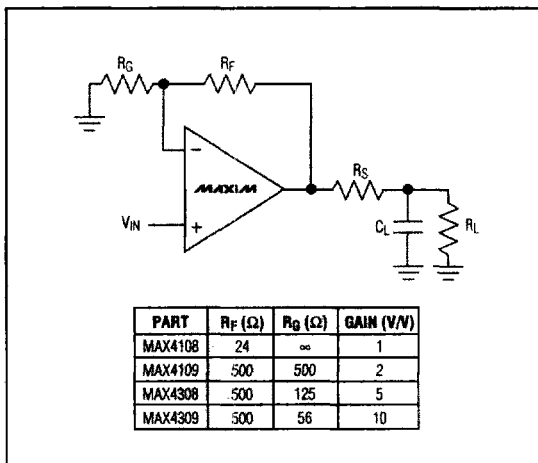

Figure 1a. Using an Isolation Resistor for High Capacitive Loads

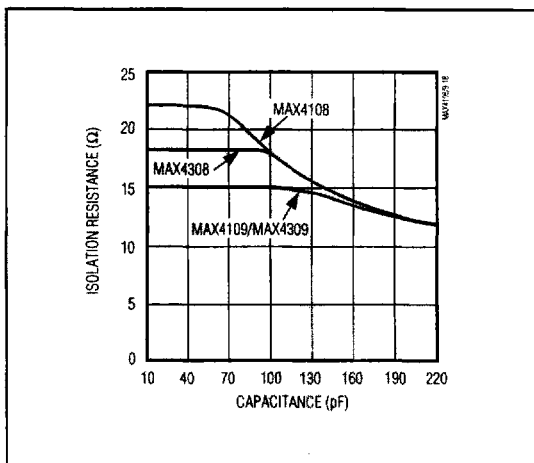

Figure 1b. Optimal Isolation Resistor (R_S) vs. Capacitive Load

MAX4108/MAX4109/MAX4308/MAX4309

400MHz, Ultra-Low-Distortion Op Amps

Driving Capacitive Loads

The MAX4108/MAX4109/MAX4308/MAX4309 are optimized for AC performance. They are not designed to drive highly reactive loads. Reactive loads will decrease phase margin and may produce excessive ringing and oscillation. Figure 1a shows a circuit that

eliminates this problem, and Figure 1b is a graph of the optimal isolation resistor (R_S) vs. capacitive load. Figures 2a–2d show how a capacitive load causes excessive peaking of the amplifier's bandwidth if the capacitive load is not isolated (R_S) from the amplifier. A small isolation resistor (usually 15Ω to 22Ω) placed

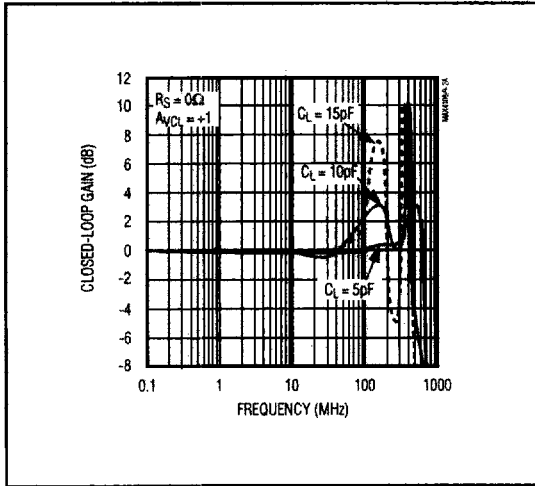

Figure 2a. MAX4108 Response vs. Capacitive Load—No Resistive (R_S) Isolation (circuit shown in Figure 1a)

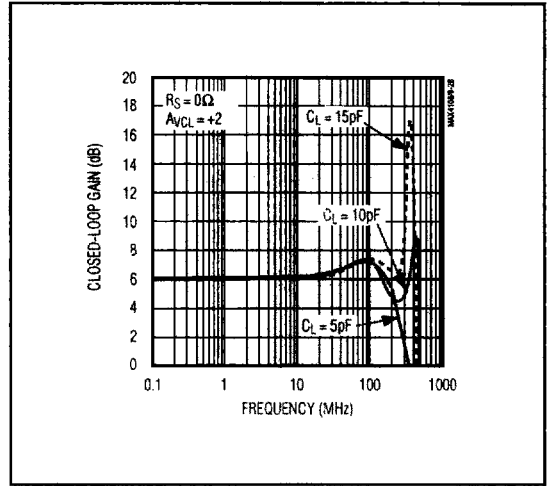

Figure 2b. MAX4109 Response vs. Capacitive Load—No Resistive (R_S) Isolation (circuit shown in Figure 1a)

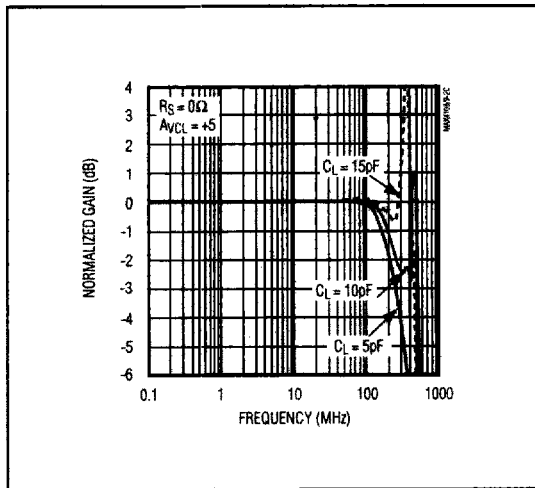

Figure 2c. MAX4308 Response vs. Capacitive Load—No Resistive (R_S) Isolation (circuit shown in Figure 1a)

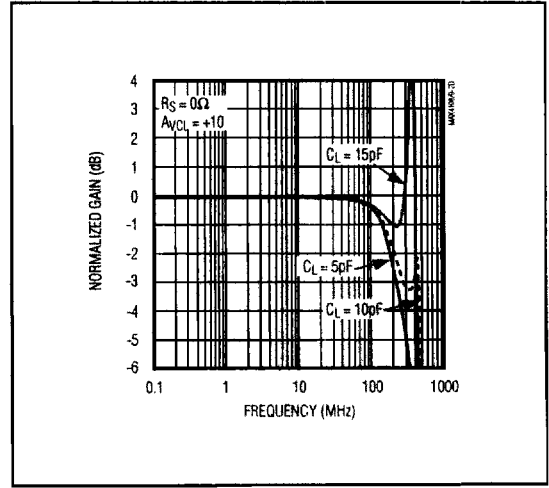

Figure 2d. MAX4309 Response vs. Capacitive Load—No Resistive (R_S) Isolation (circuit shown in Figure 1a)

400MHz, Ultra-Low-Distortion Op Amps

MAX4108/MAX4109/MAX4308/MAX4309

before the reactive load prevents ringing and oscillation. At higher capacitive loads, AC performance will be controlled by the interaction of the load capacitance and isolation resistor. Figures 3a–3c show the effect of an isolation resistor on the MAX4108/MAX4109/MAX4308/MAX4309 closed-loop response.

Coaxial cable and other transmission lines are easily driven when terminated at both ends with their characteristic impedance. When driving back-terminated transmission lines, the capacitance of the transmission line is essentially eliminated.

ADC Input Buffers

Input buffer amplifiers can be a source of significant errors in high-speed ADC applications. The input buffer is usually required to rapidly charge and discharge the ADC's input, which is often capacitive (see the section *Driving Capacitive Loads*). In addition, a high-speed ADC's input impedance often changes very rapidly during the conversion cycle, requiring an amplifier with very low output impedance at high frequencies to maintain measurement accuracy. The combination of high speed, fast slew rate, low noise, and a low and stable distortion over load makes the MAX4108/MAX4109/MAX4308/MAX4309 ideally suited for use as buffer amplifiers in high-speed ADC applications.

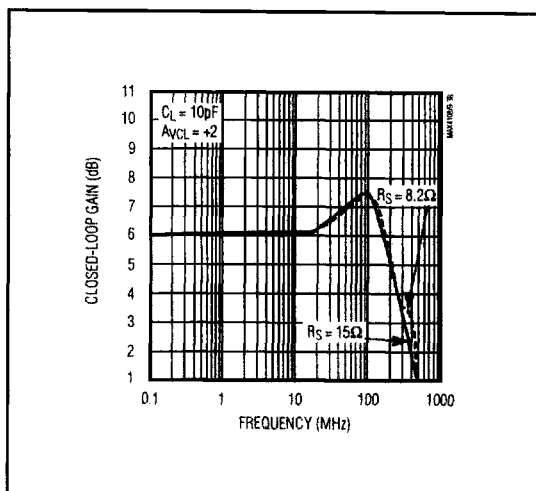

Figure 3b. MAX4308 Response vs. Capacitive Load with Resistive (R_S) Isolation (circuit shown in Figure 1a)

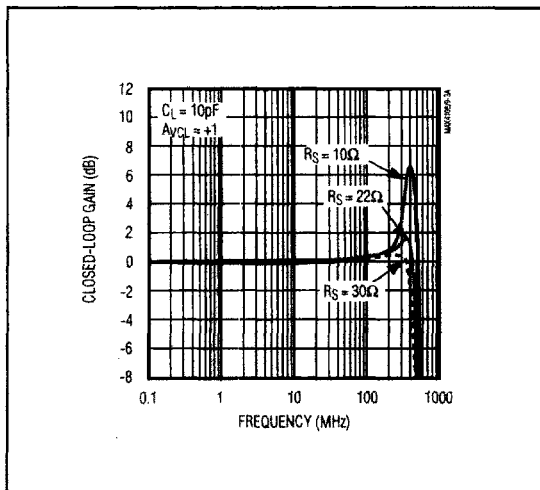

Figure 3a. MAX4108 Response vs. Capacitive Load with Resistive (R_S) Isolation (circuit shown in Figure 1a)

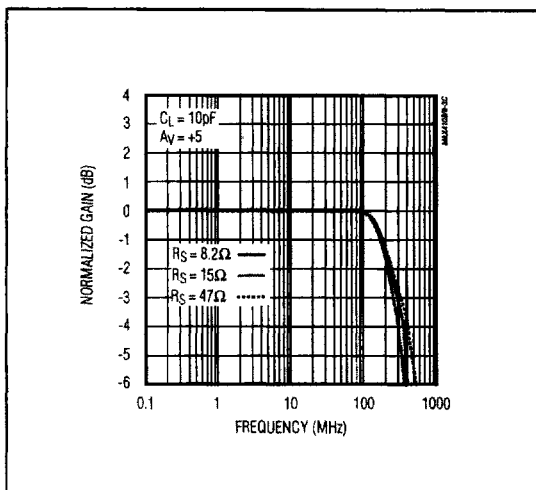

Figure 3c. MAX4108/MAX4309 Response vs. Capacitive Load with Resistive (R_S) Isolation (circuit shown in Figure 1a)

400MHz, Ultra-Low-Distortion Op Amps

MAX4108/MAX4109/MAX4308/MAX4309

_____ **Chip Information**

TRANSISTOR COUNT: 57

SUBSTRATE CONNECTED TO VEE