

3W Mono/Stereo BTL Audio Power Amplifiers with Shutdown

General Description

The MAX9710/MAX9711 are stereo/mono 3W bridge-tied load (BTL) audio power amplifiers. These devices are PC99/01 compliant, operate from a single 4.5V to 5.5V supply, and feature an industry-leading 100dB PSRR, which allows these devices to operate from noisy supplies without additional, costly power-supply conditioning. An ultra-low 0.005% THD+N ensures clean, low-distortion amplification of the audio signal while patented click-and-pop suppression eliminates audible transients on power and shutdown cycles. Power-saving features include low 2mV V_{OS} (minimizing DC current drain through the speakers), low 7mA supply current, and a 0.5 μ A shutdown mode. A MUTE function allows the outputs to be quickly enabled or disabled.

These devices include thermal overload protection, are specified over the extended -40°C to +85°C temperature range, and are supplied in thermally efficient packages. The MAX9710 is available in a 20-pin thin QFN package (5mm \times 5mm \times 0.8mm). The MAX9711 is available in a 12-pin thin QFN package (4mm \times 4mm \times 0.8mm).

Applications

Notebook PCs
Flat-Panel TVs
Flat-Panel PC Displays
Two-Way Radios
General-Purpose Audio
Powered Speakers

Pin Configurations

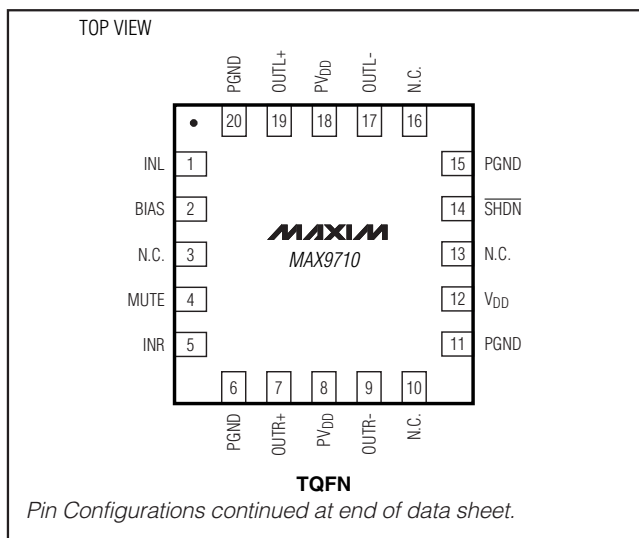

Features

- ◆ 3W into 3 Ω (1% THD+N)
- ◆ 4W into 3 Ω (10% THD+N)
- ◆ Industry-Leading, Ultra-High 100dB PSRR
- ◆ PC99/01 Compliant
- ◆ Patented Click-and-Pop Suppression
- ◆ Low 0.005% THD+N
- ◆ Low Quiescent Current: 7mA
- ◆ Low-Power Shutdown Mode: 0.5 μ A
- ◆ MUTE Function
- ◆ Tiny 20-Pin Thin QFN (5mm \times 5mm \times 0.8mm)

Ordering Information

PART	TEMP RANGE	PIN-PACKAGE	AMP
MAX9710ETP	-40°C to +85°C	20-Thin QFN-EP*	Stereo
MAX9711ETC	-40°C to +85°C	12-Thin QFN-EP*	Mono

*EP = Exposed pad.

Simplified Block Diagram

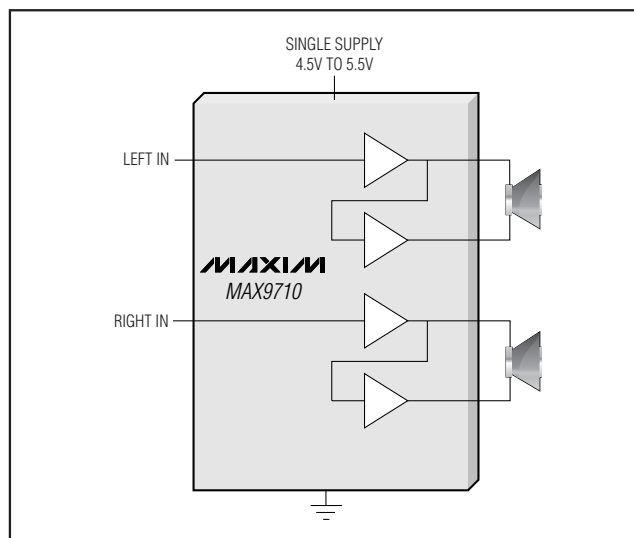

3W Mono/Stereo BTL Audio Power Amplifiers with Shutdown

ABSOLUTE MAXIMUM RATINGS

V _{DD} to GND, PGND	+6V
PV _{DD} to V _{DD}	±0.3V
PGND to GND	±0.3V
All Other Pins to GND	-0.3V to (V _{DD} + 0.3V)
Continuous Input Current (into any pin except power supply and output pins)	±20mA
Continuous Power Dissipation (T _A = +70°C) 12-Pin Thin QFN (derate 16.9mW/°C above +70°C)	1349mW

20-Pin Thin QFN (derate 20.8mW/°C above +70°C)	1667mW
Operating Temperature Range	-40°C to +85°C
Storage Temperature Range	-65°C to +150°C
Junction Temperature	+150°C
Lead Temperature (soldering, 10s)	+300°C

Stresses beyond those listed under "Absolute Maximum Ratings" may cause permanent damage to the device. These are stress ratings only, and functional operation of the device at these or any other conditions beyond those indicated in the operational sections of the specifications is not implied. Exposure to absolute maximum rating conditions for extended periods may affect device reliability.

ELECTRICAL CHARACTERISTICS

(V_{DD} = PV_{DD} = 5.0V, V_{GND} = V_{PGND} = V_{MUTE} = 0V, V_{SHDN} = 5V, R_{IN} = R_F = 15kΩ, R_L = ∞. T_A = T_{MIN} to T_{MAX}, unless otherwise noted. Typical values are at T_A = +25°C.) (Note 1)

PARAMETER	SYMBOL	CONDITIONS	MIN	TYP	MAX	UNITS
Supply Voltage Range	V _{DD} /PV _{DD}	Inferred from PSRR test	4.5		5.5	V
Quiescent Supply Current (I _{VDD} + I _{PVDD})	I _{DD}	MAX9710		12	30	mA
		MAX9711		7	17	
Shutdown Supply Current	I _{SHDN}	SHDN = GND		0.5	30	μA
Turn-On Time	t _{ON}	C _{BIAS} = 1μF (10% of final value)		300		ms
		C _{BIAS} = 0.1μF (10% of final value)		30		
Thermal Shutdown Threshold				160		°C
Thermal Shutdown Hysteresis				15		°C
OUTPUT AMPLIFIERS						
Output Offset Voltage	V _{OS}	V _{OUT+} - V _{OUT-} , A _v = 2		±2	±14	mV
Power-Supply Rejection Ratio	PSRR	V _{RIPPLE} = 200mV _{P-P} (Note 2)	V _{DD} = 4.5V to 5.5V	82	100	dB
			f = 1kHz		87	
			f = 20kHz		74	
Output Power	P _{OUT}	f _{IN} = 1kHz, THD+N < 1%	R _L = 8Ω	1.1	1.4	W
			R _L = 4Ω		2.6	
			R _L = 3Ω		3	
Total Harmonic Distortion Plus Noise	THD+N	f _{IN} = 1kHz, BW = 22Hz to 22kHz	P _{OUT} = 1.2W, R _L = 8Ω	0.005		%
			P _{OUT} = 2W, 4Ω	0.01		
Signal-to-Noise Ratio	SNR	R _L = 8Ω, V _{OUT} = 2.8V _{RMS} , BW = 22Hz to 22kHz		95		dB
Slew Rate	SR			1.6		V/μs
Maximum Capacitive Load Drive	C _L	No sustained oscillations		1		nF
Crosstalk		f _{IN} = 10kHz		77		dB
BIAS VOLTAGE (BIAS)						
BIAS Voltage	V _{BIAS}		2.35	2.5	2.65	V
Output Resistance	R _{BIAS}			50		kΩ
DIGITAL INPUTS (MUTE, SHDN)						
Input Voltage High	V _{IH}		2			V
Input Voltage Low	V _{IL}				0.8	V
Input Leakage Current	I _{IN}				±1	μA

Note 1: All devices are 100% production tested at +25°C. All temperature limits are guaranteed by design.

Note 2: PSSR is specified with the amplifier inputs connected to GND through R_{IN} and C_{IN}.

3W Mono/Stereo BTL Audio Power Amplifiers with Shutdown

Typical Operating Characteristics

($V_{DD} = 5V$, THD+N measurement bandwidth = 22Hz to 22kHz, $T_A = +25^\circ C$, unless otherwise noted.)

MAX9710/MAX9711

TOTAL HARMONIC DISTORTION PLUS NOISE vs. FREQUENCY

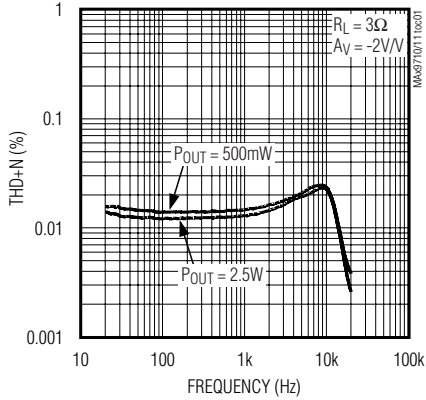

TOTAL HARMONIC DISTORTION PLUS NOISE vs. FREQUENCY

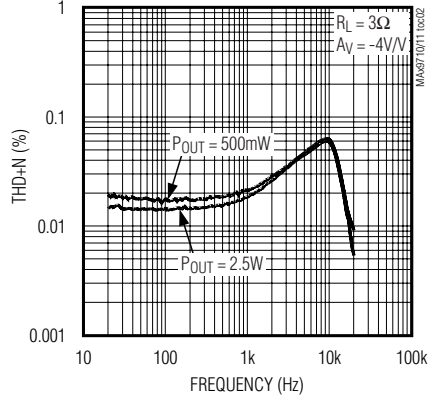

TOTAL HARMONIC DISTORTION PLUS NOISE vs. FREQUENCY

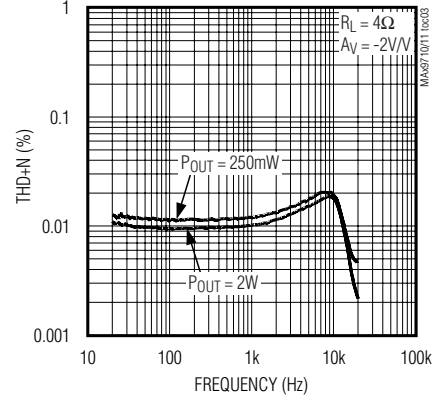

TOTAL HARMONIC DISTORTION PLUS NOISE vs. FREQUENCY

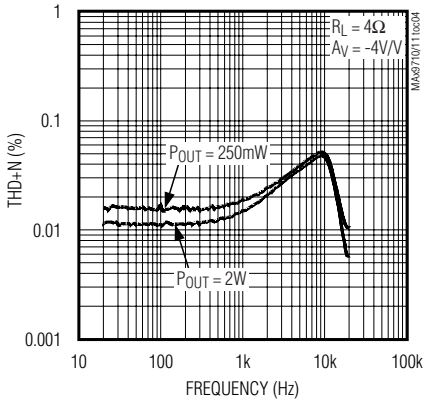

TOTAL HARMONIC DISTORTION PLUS NOISE vs. FREQUENCY

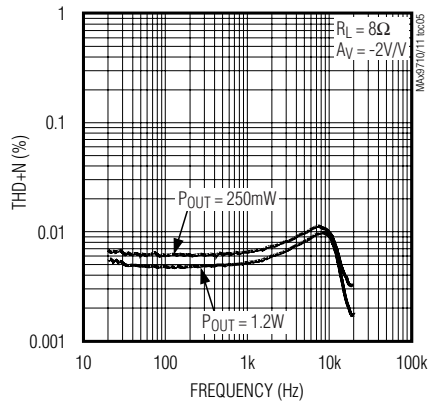

TOTAL HARMONIC DISTORTION PLUS NOISE vs. FREQUENCY

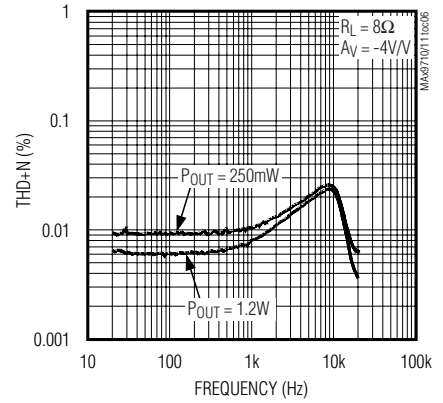

TOTAL HARMONIC DISTORTION PLUS NOISE vs. OUTPUT POWER

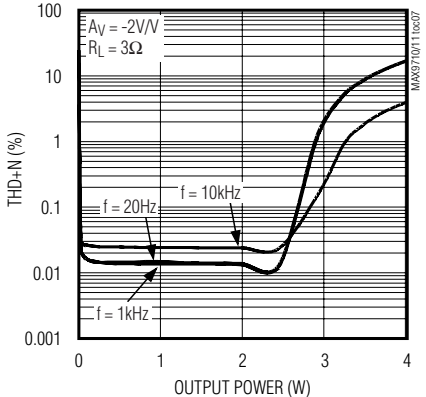

TOTAL HARMONIC DISTORTION PLUS NOISE vs. OUTPUT POWER

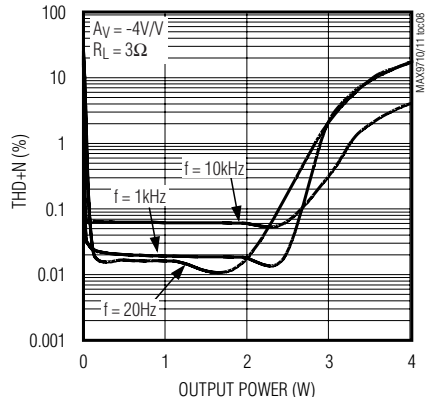

TOTAL HARMONIC DISTORTION PLUS NOISE vs. OUTPUT POWER

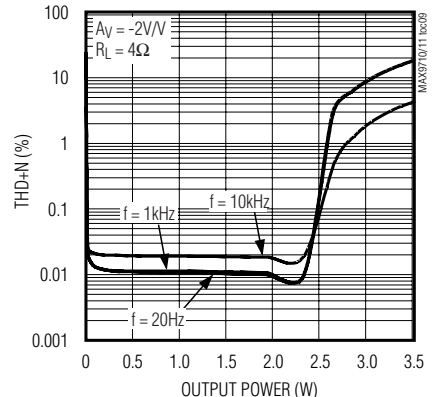

3W Mono/Stereo BTL Audio Power Amplifiers with Shutdown

Typical Operating Characteristics (continued)

($V_{DD} = 5V$, THD+N measurement bandwidth = 22Hz to 22kHz, $T_A = +25^\circ C$, unless otherwise noted.)

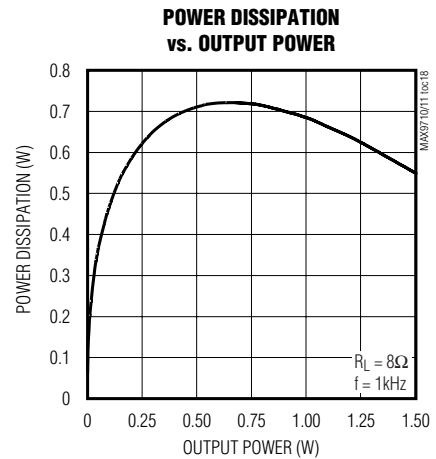
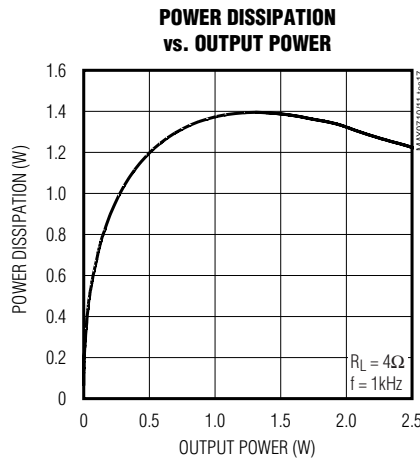
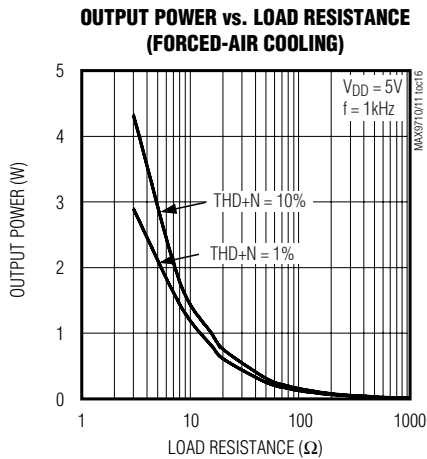
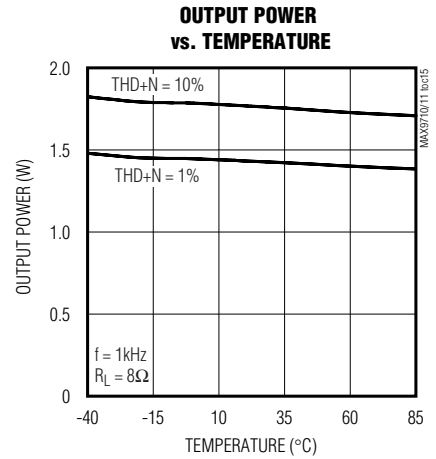
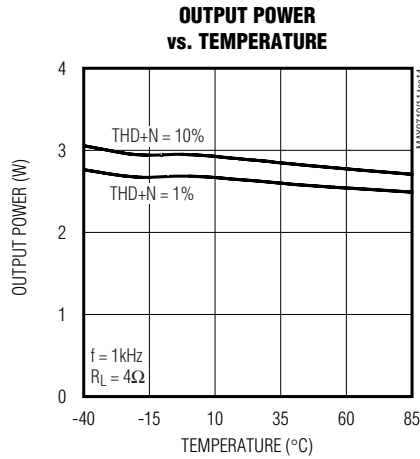
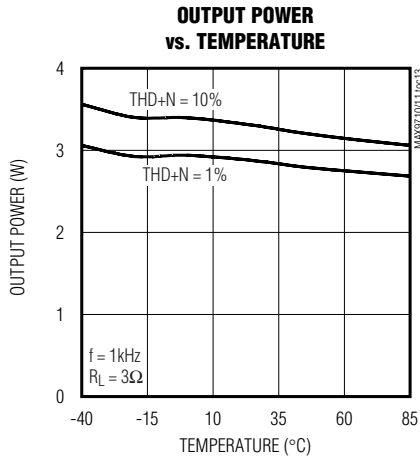
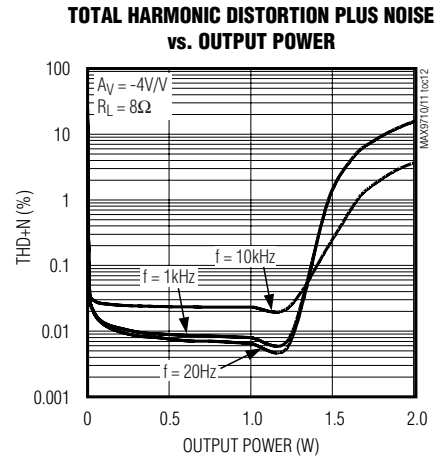
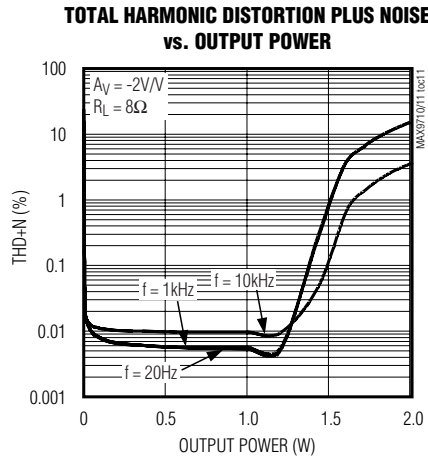
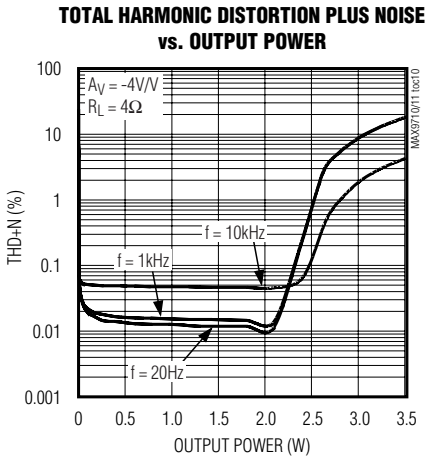

3W Mono/Stereo BTL Audio Power Amplifiers with Shutdown

Typical Operating Characteristics (continued)

($V_{DD} = 5V$, THD+N measurement bandwidth = 22Hz to 22kHz, $T_A = +25^\circ C$, unless otherwise noted.)

MAX9710/MAX9711

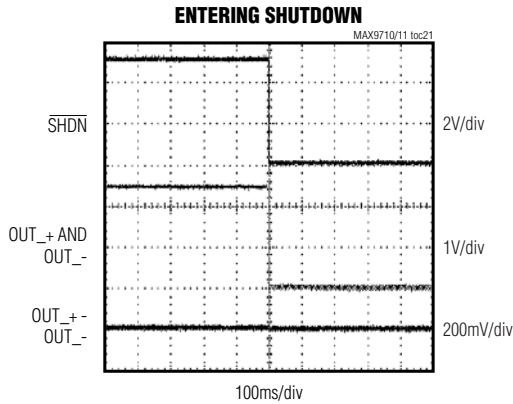
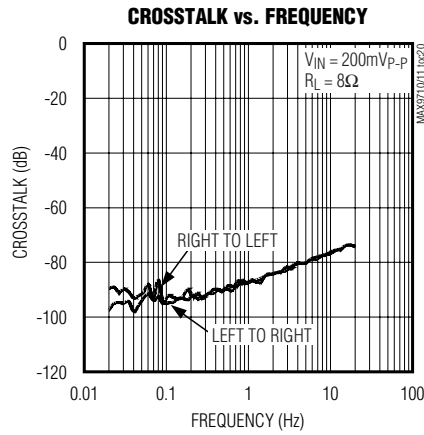
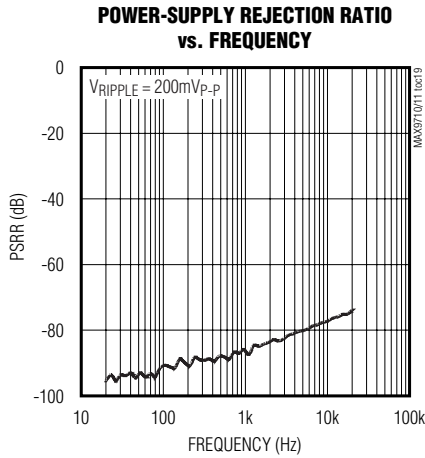

$R_L = 8\Omega$
INPUT AC-COUPLED TO GND

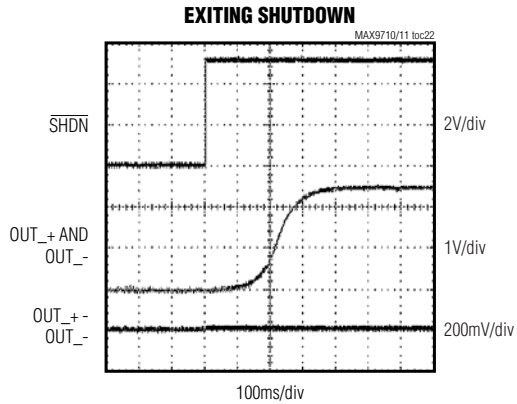

$R_L = 8\Omega$
INPUT AC-COUPLED TO GND

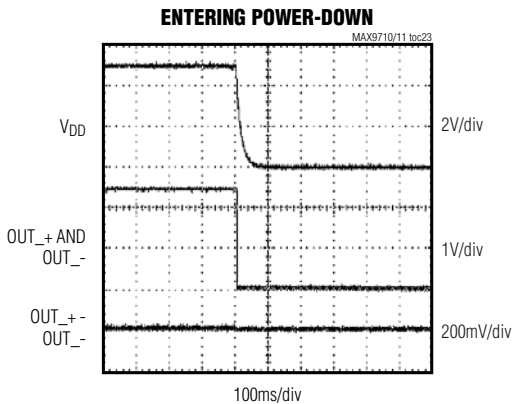

$R_L = 8\Omega$
INPUT AC-COUPLED TO GND

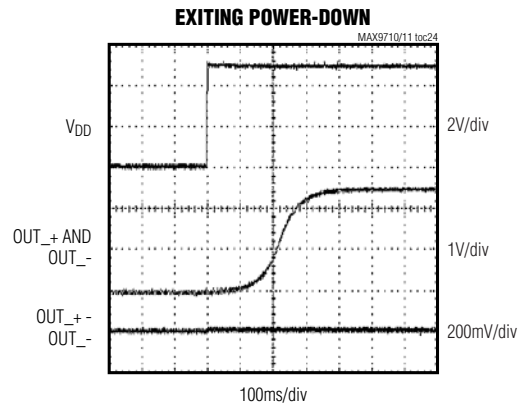

$R_L = 8\Omega$
INPUT AC-COUPLED TO GND

3W Mono/Stereo BTL Audio Power Amplifiers with Shutdown

Typical Operating Characteristics (continued)

($V_{DD} = 5V$, THD+N measurement bandwidth = 22Hz to 22kHz, $T_A = +25^\circ C$, unless otherwise noted.)

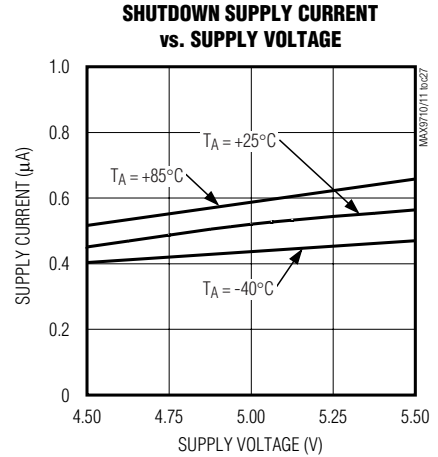
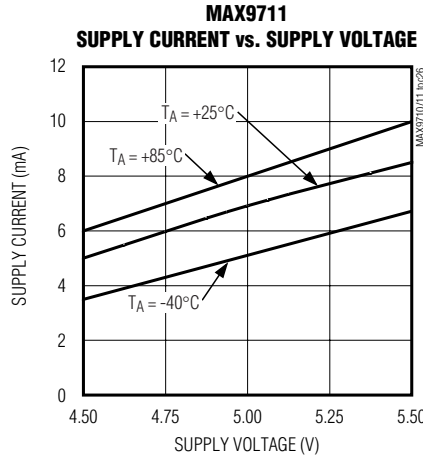
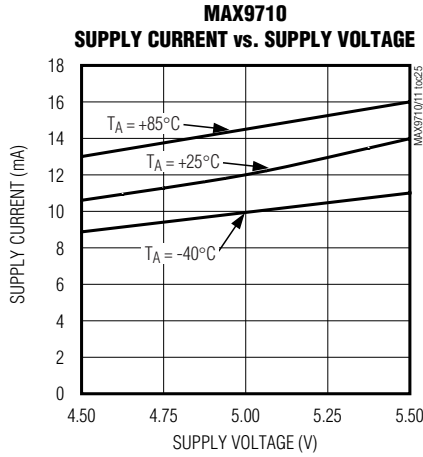

Pin Description

PIN		NAME	FUNCTION
MAX9710	MAX9711		
1	—	INL	Left-Channel Input
2	7	BIAS	DC Bias Bypass. See <i>BIAS Capacitor</i> section for capacitor selection.
3, 10, 13, 16	—	N.C.	No Connection. Not internally connected.
4	9	MUTE	Active-High Mute Input
5	—	INR	Right-Channel Input
6, 11, 15, 20	1, 3	PGND	Power Ground
7	—	OUTR+	Right-Channel Bridged Amplifier Positive Output
8, 18	5, 11	PV _{DD}	Output Amplifier Power Supply
9	—	OUTR-	Right-Channel Bridged Amplifier Negative Output
12	8	V _{DD}	Power Supply
14	10	\overline{SHDN}	Active-Low Shutdown. Connect \overline{SHDN} to V _{DD} for normal operation.
17	—	OUTL-	Left-Channel Bridged Amplifier Negative Output
19	—	OUTL+	Left-Channel Bridged Amplifier Positive Output
—	2	IN	Amplifier Input
—	6	GND	Ground
—	12	OUT-	Bridged Amplifier Negative Output
—	4	OUT+	Bridged Amplifier Positive Output
—	—	EP	Exposed Pad. Connect to ground plane.

3W Mono/Stereo BTL Audio Power Amplifiers with Shutdown

MAX9710/MAX9711

Detailed Description

The MAX9710/MAX9711 are 3W BTL speaker amplifiers. The MAX9710 is a stereo speaker amplifier, while the MAX9711 is a mono speaker amplifier. Both devices feature a low-power shutdown mode, MUTE mode, and comprehensive click-and-pop suppression. These devices consist of high output-current op amps configured as BTL amplifiers (see *Functional Diagrams*). The device gain is set by R_F and R_{IN} .

BIAS

These devices operate from a single 5V supply and feature an internally generated, power-supply-independent, common-mode bias voltage of 2.5V referenced to ground. BIAS provides both click-and-pop suppression and sets the DC bias level for the audio outputs. BIAS is internally connected to the noninverting input of each speaker amplifier (see *Functional Diagrams*). Choose the value of the bypass capacitor as described in the *BIAS Capacitor* section. No external load should be applied to BIAS. Any load lowers the BIAS voltage, affecting the overall performance of the device.

Shutdown

The MAX9710/MAX9711 feature a 0.5 μ A low-power shutdown mode that reduces quiescent current consumption. Pulling $\overline{\text{SHDN}}$ low disables the device's bias circuitry, the amplifier outputs are actively pulled low, and BIAS is driven to GND. Connect SHDN to V_{DD} for normal operation.

MUTE

Both devices feature a clickless/popless MUTE mode. When the device is muted, the input disconnects from the amplifier. MUTE only affects the power amplifiers and does not shut down the device. Drive MUTE high to mute the device. Drive MUTE low for normal operation.

Click-and-Pop Suppression

The MAX9710/MAX9711 feature Maxim's patented comprehensive click-and-pop suppression. During startup, the common-mode bias voltage of the amplifiers slowly ramps to the DC bias point using an S-shaped waveform. When entering shutdown, the amplifier outputs are actively driven low simultaneously. This scheme minimizes the energy present in the audio band.

For optimum click-and-pop suppression, choose:

$$R_{IN} \times C_{IN} < R_{BIAS} \times C_{BIAS}$$

where $R_{BIAS} = 50k\Omega$.

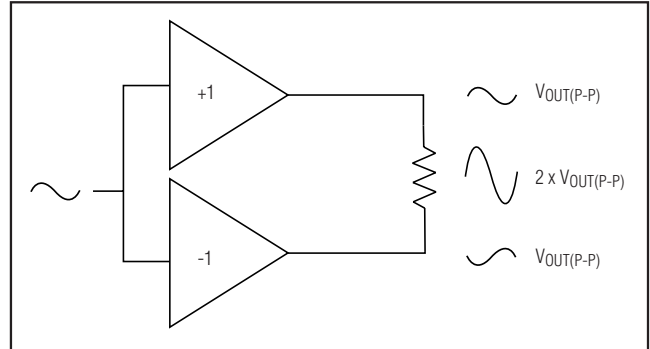

Figure 1. Bridge-Tied Load Configuration

Applications Information

BTL Amplifier

The MAX9710/MAX9711 are designed to drive a load differentially, a configuration referred to as BTL. The BTL configuration (Figure 1) offers advantages over the single-ended configuration, where one side of the load is connected to ground. Driving the load differentially doubles the output voltage compared to a single-ended amplifier under similar conditions. Thus, the differential gain of the device is twice the closed-loop gain of the input amplifier. The effective gain is given by:

$$A_{VD} = 2 \times \frac{R_F}{R_{IN}}$$

Substituting $2 \times V_{OUT(P-P)}$ for $V_{OUT(P-P)}$ into the following equations yields four times the output power due to doubling of the output voltage:

$$V_{RMS} = \frac{V_{OUT(P-P)}}{2\sqrt{2}}$$

$$P_{OUT} = \frac{V_{RMS}^2}{R_L}$$

Since the differential outputs are biased at midsupply, there is no net DC voltage across the load. This eliminates the need for DC-blocking capacitors required for single-ended amplifiers. These capacitors can be large, expensive, consume board space, and degrade low-frequency performance.

3W Mono/Stereo BTL Audio Power Amplifiers with Shutdown

Power Dissipation and Heat Sinking

Under normal operating conditions, the MAX9710/MAX9711 dissipate a significant amount of power. The maximum power dissipation for each package is given in the *Absolute Maximum Ratings* section under Continuous Power Dissipation or can be calculated by the following equation:

$$P_{\text{DISSPKG(MAX)}} = \frac{T_{\text{J(MAX)}} - T_{\text{A}}}{\theta_{\text{JA}}}$$

where $T_{\text{J(MAX)}}$ is +150°C, T_{A} is the ambient temperature, and θ_{JA} is the reciprocal of the derating factor in °C/W as specified in the *Absolute Maximum Ratings* section. For example, θ_{JA} of the 20-pin thin QFN package is 48.1°C/W.

The increase in power delivered by the BTL configuration directly results in an increase in internal power dissipation over the single-ended configuration. The maximum power dissipation for a given V_{DD} and load is given by the following equation:

$$P_{\text{DISS(MAX)}} = \frac{2V_{\text{DD}}^2}{\pi^2 R_{\text{L}}}$$

If the power dissipation for a given application exceeds the maximum allowed for a given package, either reduce V_{DD} , increase load impedance, decrease the ambient temperature, or add heat sinking to the device (see *Layout and Grounding* section). Large output, supply, and ground PC board traces improve the maximum power dissipation in the package.

Thermal-overload protection limits total power dissipation in the MAX9710/MAX9711. When the junction temperature exceeds +160°C, the thermal protection circuitry disables the amplifier output stage. The amplifiers are enabled once the junction temperature cools by 15°C. A pulsing output under continuous thermal-overload conditions results as the device heats and cools.

Component Selection

Gain-Setting Resistors

External feedback components set the gain of both devices. Resistors R_{F} and R_{IN} (*Functional Diagrams*) set the gain of the amplifier as follows:

$$A_{\text{VD}} = 2 \times \frac{R_{\text{F}}}{R_{\text{IN}}}$$

Input Filter

The input capacitor (C_{IN}), in conjunction with R_{IN} , forms a highpass filter that removes the DC bias from an incoming signal. The AC-coupling capacitor allows the amplifier to bias the signal to an optimum DC level. Assuming zero-source impedance, the -3dB point of the highpass filter is given by:

$$f_{-3\text{dB}} = \frac{1}{2\pi R_{\text{IN}} C_{\text{IN}}}$$

For optimum click-and-pop suppression, choose:

$$R_{\text{IN}} \times C_{\text{IN}} < R_{\text{BIAS}} \times C_{\text{BIAS}}$$

where $R_{\text{BIAS}} = 50\text{k}\Omega$.

Setting $f_{-3\text{dB}}$ too high affects the low-frequency response of the amplifier. Use capacitors with dielectrics that have low-voltage coefficients, such as tantalum or aluminum electrolytic. Capacitors with high-voltage coefficients, such as ceramics, may result in an increase of distortion at low frequencies.

BIAS Capacitor

BIAS is the output of the internally generated 2.5VDC bias voltage. The BIAS bypass capacitor, C_{BIAS} , improves PSRR and THD+N by reducing power supply and other noise sources at the common-mode bias node, and also generates the clickless/popless startup DC bias waveform for the speaker amplifiers. Bypass BIAS with a 1 μF capacitor to GND. Smaller values of C_{BIAS} produce faster $t_{\text{ON}}/t_{\text{OFF}}$ times but may result in increased click/pop levels.

Supply Bypassing

Proper power-supply bypassing ensures low-noise, low-distortion performance. Place a 0.1 μF ceramic capacitor from V_{DD} to PGND. Add additional bulk capacitance as required by the application. Locate the bypass capacitor as close to the device as possible.

Piezoelectric Speaker Driver

Low-profile piezoelectric speakers can provide quality sound for portable electronics. However, piezoelectric speakers typically require large voltage swings (>8V_{P-P}) across the speaker element to produce audible sound pressure levels. The MAX9711 can be configured to drive a piezoelectric speaker with up to 10V_{P-P} while operating from a single 5V supply.

Figure 2 shows the THD+N of the MAX9711 driving a piezoelectric speaker. Note that as frequency increases, the THD+N increases. This is due to the capacitive nature of the piezoelectric speaker; as frequency increases, the speaker impedance decreases, resulting in a larger current draw from the amplifier.

3W Mono/Stereo BTL Audio Power Amplifiers with Shutdown

MAX9710/MAX9711

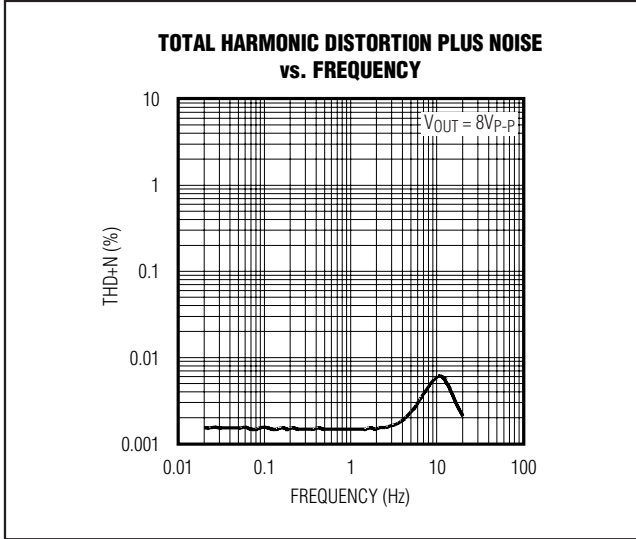

Figure 2. MAX9711 Piezoelectric Speaker Driver THD+N vs. Frequency

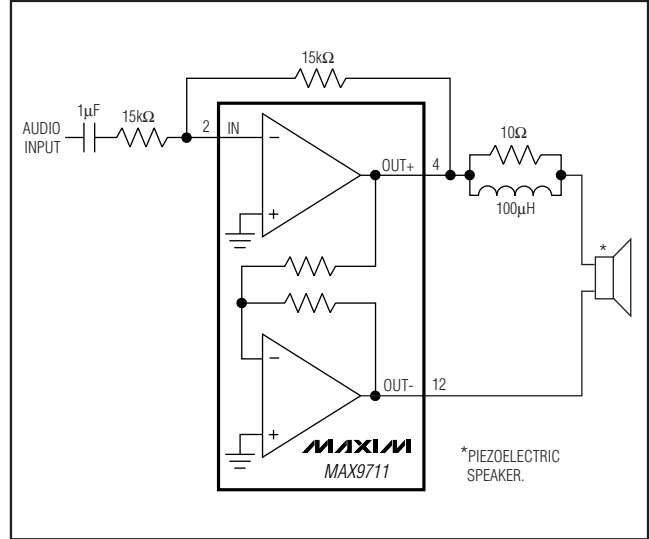

Figure 3. Isolation Network for Driving a Piezoelectric Speaker

The capacitive nature of the piezoelectric speaker may cause the MAX9711 to become unstable. A simple inductor/resistor network in series with the speaker isolates the speaker capacitance from the driver and ensures that the device output sees a resistive load of about 10Ω at high frequency, thereby maintaining stability (Figure 3).

Layout and Grounding

Good PC board layout is essential for optimizing performance. Use large traces for the power-supply inputs and amplifier outputs to minimize losses due to parasitic trace resistance and route heat away from the device. Good grounding improves audio performance, minimizes crosstalk between channels, and prevents any digital switching noise from coupling into the audio signal.

The MAX9710/MAX9711 thin QFN package features an exposed thermal pad on the underside. This pad lowers the thermal resistance of the package by providing a direct-heat conduction path from the die to the printed circuit board. Connect the exposed pad to the ground plane using multiple vias, if required. For optimum performance, connect to the ground planes as shown in Figure 4.

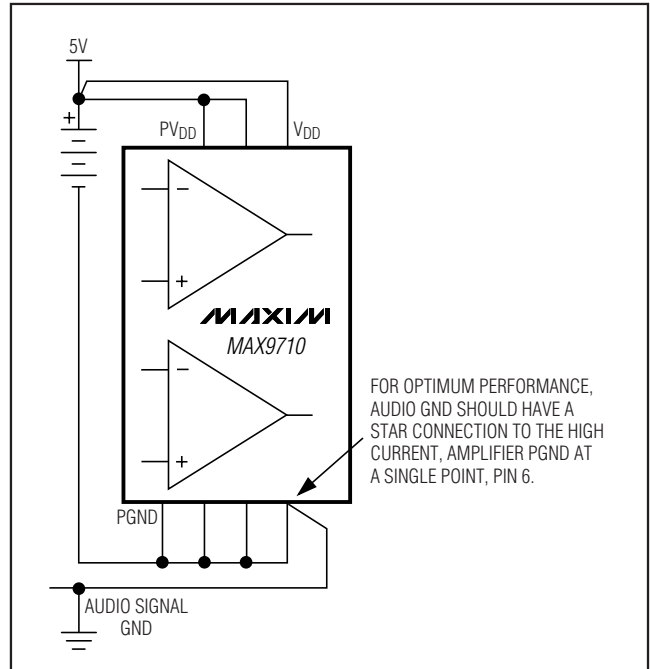
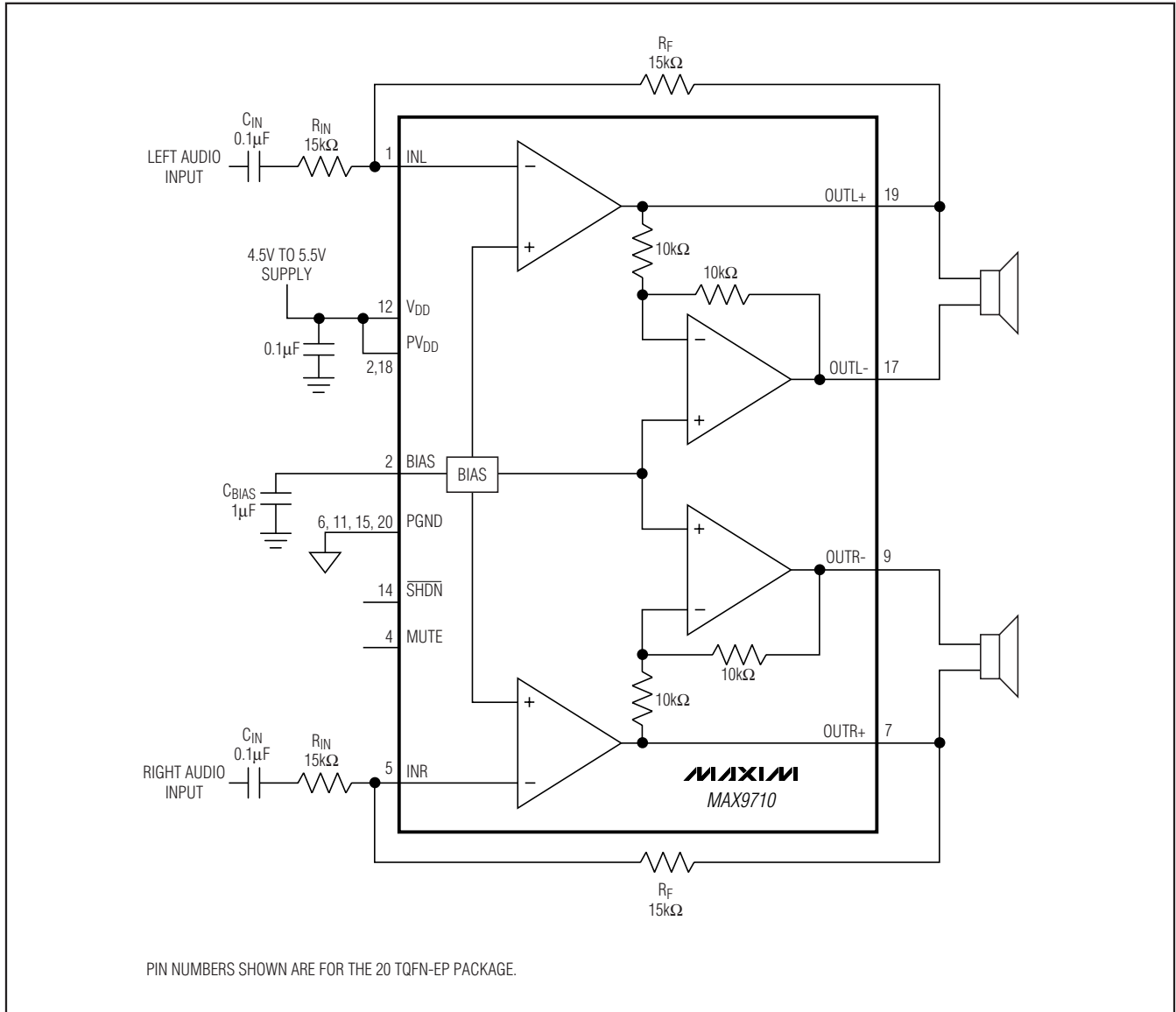

Figure 4. MAX9710 Audio Ground Connection

3W Mono/Stereo BTL Audio Power Amplifiers with Shutdown

Functional Diagrams



3W Mono/Stereo BTL Audio Power Amplifiers with Shutdown

Functional Diagrams (continued)

MAX9710/MAX9711

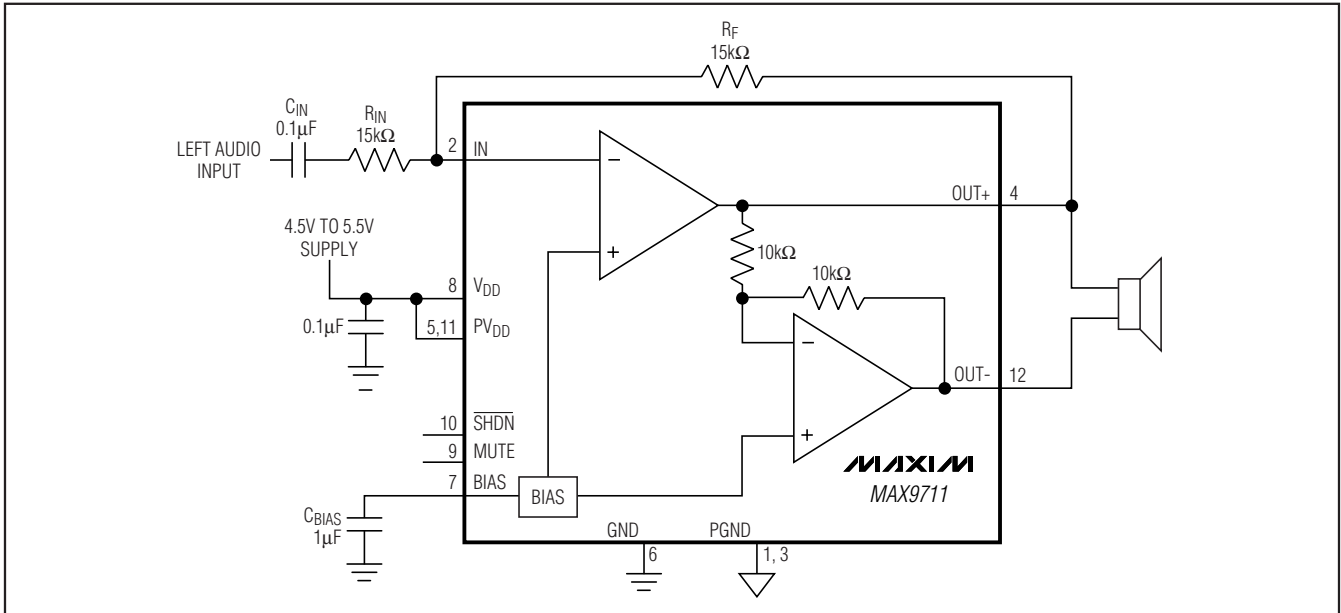

Pin Configurations (continued)

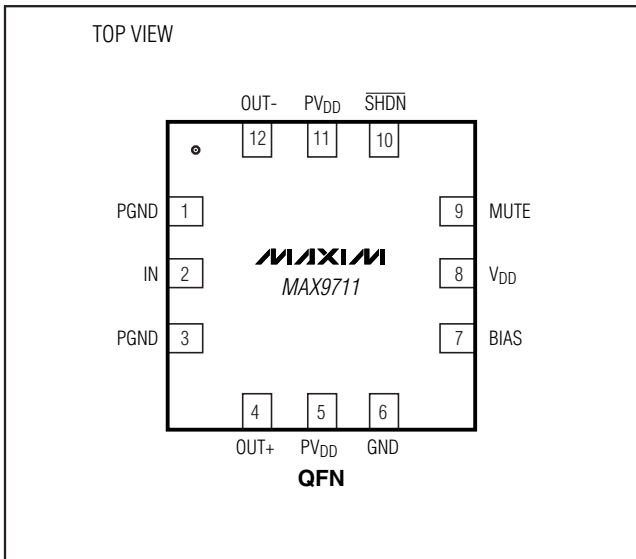

3W Mono/Stereo BTL Audio Power Amplifiers with Shutdown

System Diagram

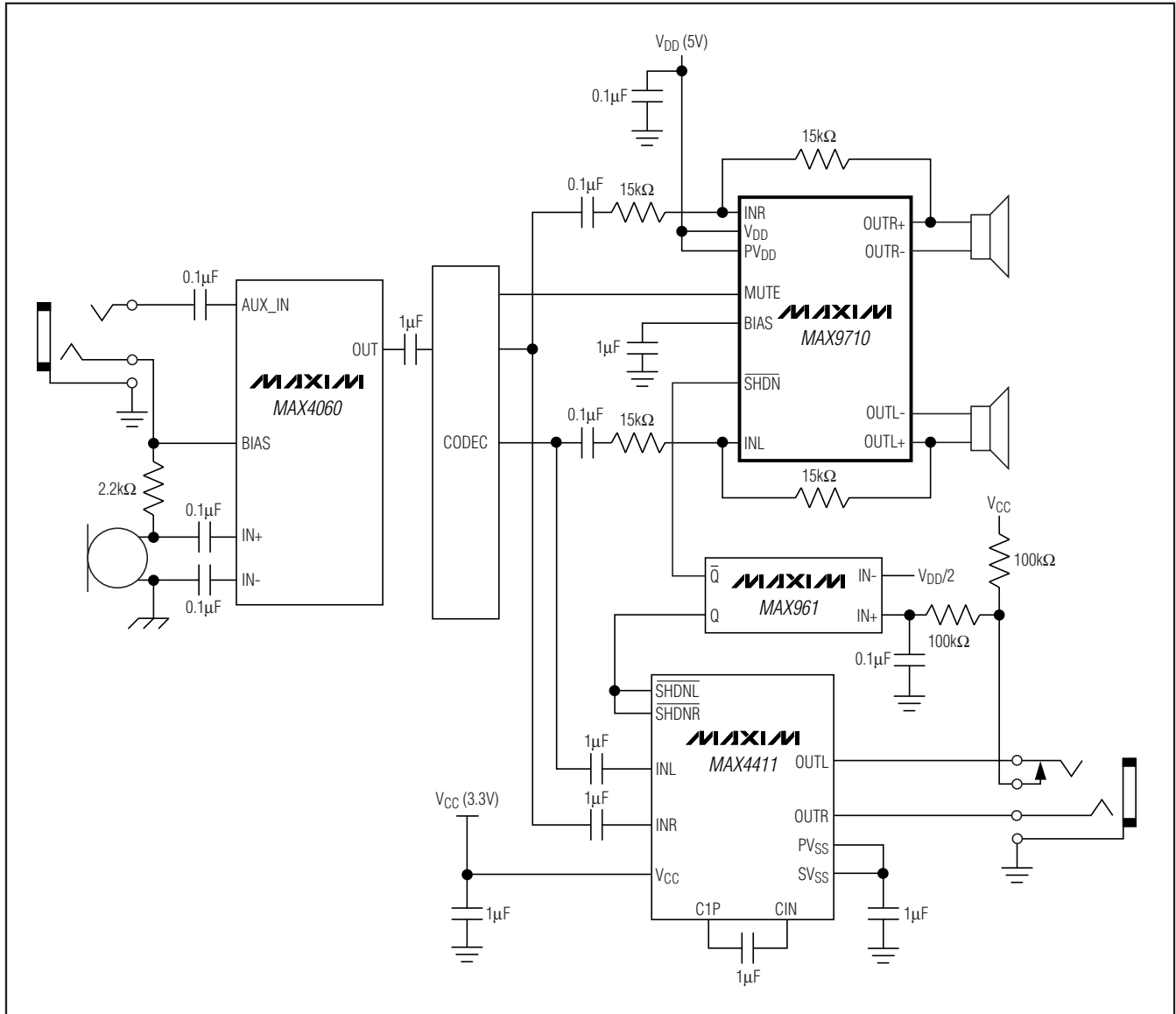

Package Information

For the latest package outline information and land patterns, go to www.maxim-ic.com/packages.

PACKAGE TYPE	PACKAGE CODE	DOCUMENT NO.
20 TQFN-EP	T2055-4	21-0140
12 TQFN-EP	T1244-4	21-0139

Chip Information

MAX9710 TRANSISTOR COUNT: 1172
 MAX9711 TRANSISTOR COUNT: 780
 PROCESS: BiCMOS

3W Mono/Stereo BTL Audio Power Amplifiers with Shutdown

Revision History

REVISION NUMBER	REVISION DATE	DESCRIPTION	PAGES CHANGED
0	4/03	Initial release	—
1	6/08	Removed TSSOP package	1, 2, 6, 9, 10

MAX9710/MAX9711

Maxim cannot assume responsibility for use of any circuitry other than circuitry entirely embodied in a Maxim product. No circuit patent licenses are implied. Maxim reserves the right to change the circuitry and specifications without notice at any time.

Maxim Integrated Products, 120 San Gabriel Drive, Sunnyvale, CA 94086 408-737-7600 _____ 13