

Description

The DIODES™ AH3231Q-AH3234Q/AH3270Q-AH3272Q are high voltage, high sensitivity, two-wire Hall Effect Unipolar/Latch switch ICs with automotive-compliant AEC-Q100 qualification; designed for position and proximity sensing in automotive applications, such as seat and seatbelt buckle, transmission actuator, gear position, wiper, door/trunk closure, etc.

To support a wide range of demanding applications, the design is optimized to operate over a supply range of 2.7V to 27V. These features include a chopper-stabilized architecture and an internal bandgap regulator to provide temperature compensated supply for internal circuits. For robustness and protection, the device has built-in reverse blocking diode with a Zener clamp on the supply.

The built-in thermal protection also shuts down the chip if temperature rises to an abnormal value. This will automatically restart the chip once the junction temperature drops below the safe value.

For the AH3231Q, AH3232Q, AH3233Q, and AH3234Q two-wire unipolar switches: when the flux density (south pole) exceeds B_{OP} , the supply current state is turned on (low or high). The output is held until a magnetic flux density falls below B_{RP} , causing output current to be turned off.

For the AH3270Q, AH3271Q, and AH3272Q two-wire latch switches: when the magnetic flux density is larger than B_{OP} , output current is turned on (high). The output state is held until a magnetic flux density reversal falls below B_{RP} , causing output current to be turned off (low).

Features and Performance

- Unipolar: AH3231Q, AH3232Q, AH3233Q, AH3234Q
Latch: AH3270Q, AH3271Q, AH3272Q
- Output Polarity:
 - Direct: AH3232Q, AH3233Q
 - Inverted: AH3231Q, AH3234Q
- Wide Supply Voltage Operation: 2.7V to 27V
- Temperature Coefficient -1100ppm/°C (AH3232Q, AH3233Q, AH3234Q)
- Chopper Stabilized Design Provides:
 - Superior Temperature Stability
 - Minimal Switch Point Drift
 - Enhanced Immunity to Stress
- Battery polarity reverse connection protection
- Transient Spike Voltage Protection
- Overtemperature Shut Down and Auto-Restart
- UVLO Protection
- High ESD Rating: HBM = 8kV, CDM = 1kV
- Temperature Range: -40°C to +150°C
- **Totally Lead-Free & Fully RoHS Compliant (Notes 1, 2)**
- **Halogen and Antimony Free. "Green" Device (Note 3)**
- **The AH3231Q-AH3234Q/AH3270Q-AH3272Q are suitable for automotive applications requiring specific change control; these parts are AEC-Q100 qualified, PPAP capable, and manufactured in IATF 16949 certified facilities.**
<https://www.diodes.com/quality/product-definitions/>

Notes:

1. No purposely added lead. Fully EU Directive 2002/95/EC (RoHS), 2011/65/EU (RoHS 2) & 2015/863/EU (RoHS 3) compliant.
2. See <https://www.diodes.com/quality/lead-free/> for more information about Diodes Incorporated's definitions of Halogen- and Antimony-free, "Green" and Lead-free.
3. Halogen- and Antimony-free "Green" products are defined as those which contain <900ppm bromine, <900ppm chlorine (<1500ppm total Br + Cl) and <1000ppm antimony compounds.

Pin Assignments

(Top View)

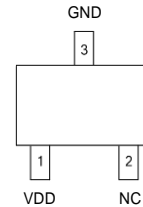

SC59 (Type A1)

(Top View)

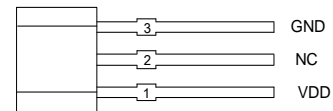

SIP-3

Applications

- Position and proximity sensing in automotive applications
- Seat positioning
- Seatbelt buckles
- Wiper positioning
- Window lifters
- Gear selection positioning

Typical Applications Circuit

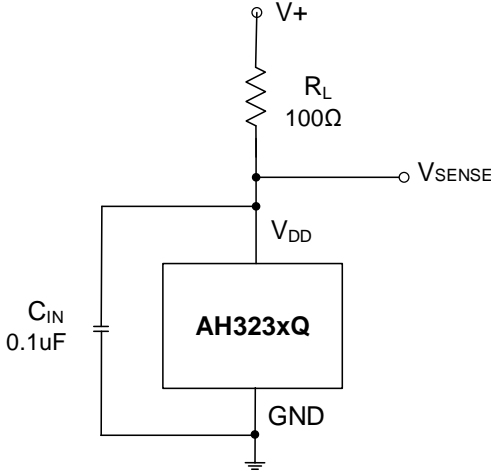

High-side sensing

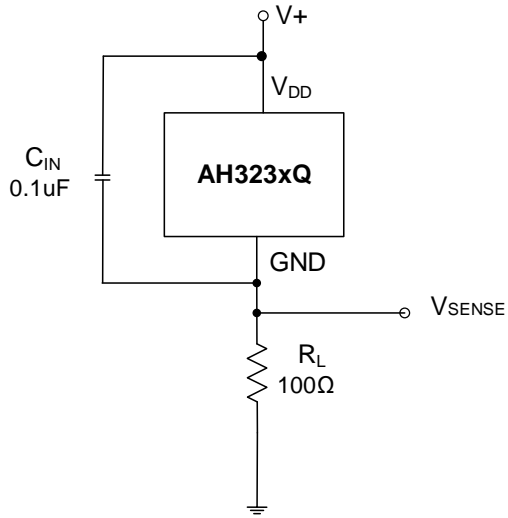

Low-side sensing

Note: 4. A 100nF or larger decoupling capacitor (CIN) between VDD and GND pins is needed for power stabilization and to strengthen noise immunity; CIN needs to be as close to IC as possible. Typical RL value is 100Ω. Larger or additional series resistor is recommended if there are disturbances on VDD.

Pin Descriptions

Package: SC59 and SIP-3 (Ammo Pack and Bulk Pack)

Pin Number	Pin Name	Function
1	V _{DD}	Supply voltage input
2	NC	No connection; can be connected to V _{DD} , GND, or left open.
3	GND	Ground

Functional Block Diagram

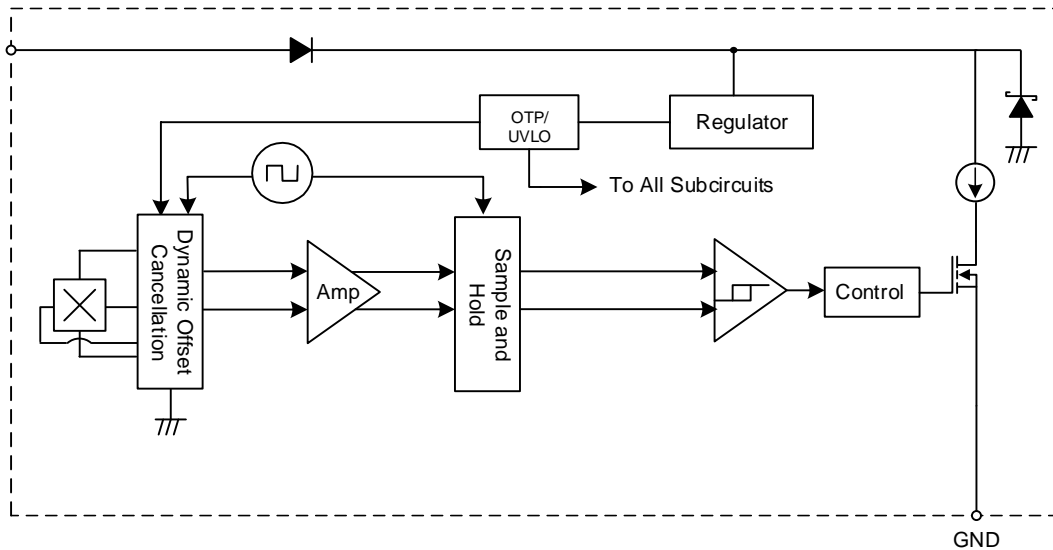

Absolute Maximum Ratings (Note 5) (@ $T_A = +25^\circ\text{C}$, unless otherwise specified.)

Symbol	Parameter	Rating	Unit
V_{DD} (Note 6)	Supply Voltage	32	V
V_{DDR} (Note 6)	Reverse Supply Voltage	-32	V
B	Magnetic Flux Density	Unlimited	Gauss
T_{J_MAX}	Maximum Junction Temperature	180	$^\circ\text{C}$
T_s	Storage Temperature	-55-180	$^\circ\text{C}$
ESD (HBM)	ESD (Human Body Model)	8000	V
ESD (CDM)	ESD (Charged Device Model)	1000	V

Notes: 5. Stresses greater than the "Absolute Maximum Ratings" specified above may cause permanent damage to the device. These are stress ratings only; functional operation of the device at these or any other conditions exceeding those indicated in this specification is not implied. Device reliability may be affected by exposure to absolute maximum rating conditions for extended periods of time.
6. Should not be exceeded the maximum junction temperature and maximum duration of 500ms.

Recommended Operating Conditions (@ $T_A = -40^\circ\text{C}$ to $+150^\circ\text{C}$, $T_J = -40^\circ\text{C}$ to $+165^\circ\text{C}$ unless otherwise specified.)

Symbol	Parameter	Min	Max	Unit
V_{DD}	Supply Voltage, between V_{DD} and GND pins	2.7	27	V
T_{OP}	Operating Ambient Temperature	-40	150	$^\circ\text{C}$

Electrical Characteristics (Note 7) (@ $T_A = -40^{\circ}\text{C}$ to $+150^{\circ}\text{C}$, $T_J = -40^{\circ}\text{C}$ to $+165^{\circ}\text{C}$, $V_{DD} = 2.7\text{V}$ to 27V , unless otherwise specified)

Symbol	Parameter	Conditions	Min	Typ	Max	Units
V_{DD}	Supply voltage (Note 8)	-	2.7	12	27	V
$I_{OFF(1)}$	Supply current off state	$V_{DD} = 2.7$ to 27 V (AH3270Q, AH3272Q)	2	3.3	5	mA
$I_{OFF(2)}$	Supply current off state	$V_{DD} = 2.7$ to 27 V (AH3231Q, AH3232Q, AH3233Q, AH3234Q, AH3271Q)	5	6	6.9	mA
I_{ON}	Supply current on state	$V_{DD} = 2.7$ to 27 V	12	14.5	17	mA
V_{UVLO}	Under voltage lockout threshold	Voltage drooping	-	2.2	2.7	V
t_{UVLO}	Under-voltage lockout reaction time	-	-	10	-	μs
I_{DDR}	Reverse supply current	$V_{DD} = -18\text{V}$, $T_A = -40^{\circ}\text{C}$ to $+150^{\circ}\text{C}$	-1.5	-	-	mA
T_{TP}	Thermal protection threshold	Junction temperature	-	190	-	$^{\circ}\text{C}$
T_{TPR}	Thermal protection release threshold	Junction temperature	-	180	-	$^{\circ}\text{C}$
F_M	Maximum magnet switching frequency	$B > 3 \cdot B_{OP}$, alternative square magnet field	30	50	-	kHz
F_C	Chopping frequency	-	-	1000	-	kHz
T_{PON}	Power on delay time (Note 9)	$B > B_{OP} + 10\text{GS}$	-	28	40	μs
T_D	Response delay time (Note 10)	$B > 3 \cdot B_{OP}$	-	7	-	μs
T_{RF}	Current rise/fall time	$V_{DD} = 12\text{V}$, No bypass capacitor, $C_{LOAD} = 50\text{pF}$ to GND	0.1	0.3	1	μs
POS	Power-up state (Notes 9, 11)	$t > T_{PON(max)}$, V_{DD} slew rate $> 1\text{V}/\mu\text{s}$	-	I_{OFF}	-	-
-	Output jitter	$B \geq 3 \cdot B_{OPMAX}$ 1000 successive square wave switching under 1KHz.	-	± 3.3	-	μs

- Notes:
7. Typical values are defined at $T_A = +25^{\circ}\text{C}$, $V_{DD} = 12\text{V}$. Maximum and minimum values over the operating temperature range are not tested in production but guaranteed by design, process control and characterization.
 8. V_{DD} is the voltage between the VDD pin and the GND pin.
 9. When power is initially turned on, V_{DD} must be operated in the correct voltage range to guarantee proper magnetic field sampling, output supply current state level is valid after the start up time of $28\mu\text{s}$ from V_{DD} higher than 2.7V . Guaranteed by design.
 10. Time delayed from the magnetic threshold reached to the output rise or fall.
 11. $t > T_{PON}$ and $B_{RP} < B < B_{OP}$.

Magnetic Characteristics (Notes 12,13) ($T_A = -40^\circ\text{C}$ to $+150^\circ\text{C}$, $T_J = -40^\circ\text{C}$ to $+165^\circ\text{C}$, $V_{DD} = 2.7\text{V}$ to 27V , unless otherwise specified)

Part Name	Test Condition	Operating Point B_{OP} (Gauss)			Release Point B_{RP} (Gauss)			Temperature Coefficient (ppm/ $^\circ\text{C}$)	I_{OFF} (mA)	Active Pole	Output Polarity
		Min	Typ	Max	Min	Typ	Max	Typ	Typ		
AH3231Q	$T_A=25^\circ\text{C}$	65	90	120	45	70	100	0	6	South	Inverted
	$T_A=-40\sim 150^\circ\text{C}$	55	90	135	35	70	115				
AH3232Q	$T_A=25^\circ\text{C}$	40	60	80	20	40	60	-1100	6	South	Direct
	$T_A=-40\sim 150^\circ\text{C}$	30	60	90	10	40	70				
AH3233Q	$T_A=25^\circ\text{C}$	27	45	63	10	28	46	-1100	6	South	Direct
	$T_A=-40\sim 150^\circ\text{C}$	20	45	70	3	28	53				
AH3234Q	$T_A=25^\circ\text{C}$	27	45	63	10	28	46	-1100	6	South	Inverted
	$T_A=-40\sim 150^\circ\text{C}$	20	45	70	3	28	53				
AH3270Q	$T_A=25^\circ\text{C}$	8	18	28	-28	-18	-8	0	3.3	South	Direct
	$T_A=-40\sim 150^\circ\text{C}$	3	18	33	-33	-18	-3				
AH3271Q	$T_A=25^\circ\text{C}$	8	18	28	-28	-18	-8	0	6	South	Direct
	$T_A=-40\sim 150^\circ\text{C}$	3	18	33	-33	-18	-3				
AH3272Q	$T_A=25^\circ\text{C}$	15	30	45	-45	-30	-15	0	3.3	South	Direct
	$T_A=-40\sim 150^\circ\text{C}$	10	30	50	-50	-30	-10				

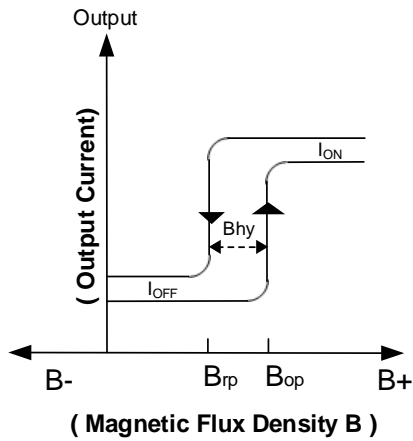
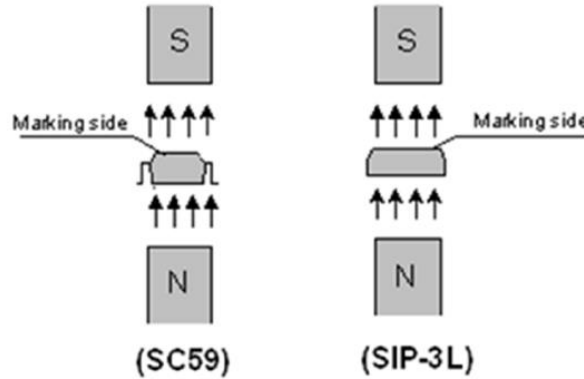

1) Direct South Pole Active

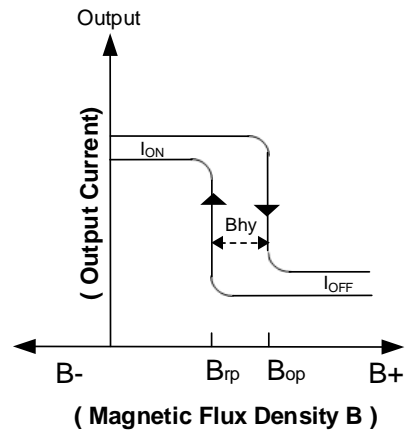

2) Inverted South Pole Active

Notes: 12. Positive x-axis direction indicates the South Pole approaching the part marking surface of SIP3 and SC59 i.e. increasing south pole magnetic field strength to the sensor; reversing direction x-axis toward 0 means the decreasing south magnetic field strength to the sensor. Negative x-axis indicates north pole magnetic field to the part marking surface.
 13. Typical values are defined at $T_A = +25^\circ\text{C}$, $V_{DD} = 12\text{V}$. Maximum and minimum values over the operating temperature range is not tested in production but guaranteed by design, process control and characterization.

Typical Operating Characteristics

AH323XQ_AH327XQ Supply Current ON, I_{ON} Performance

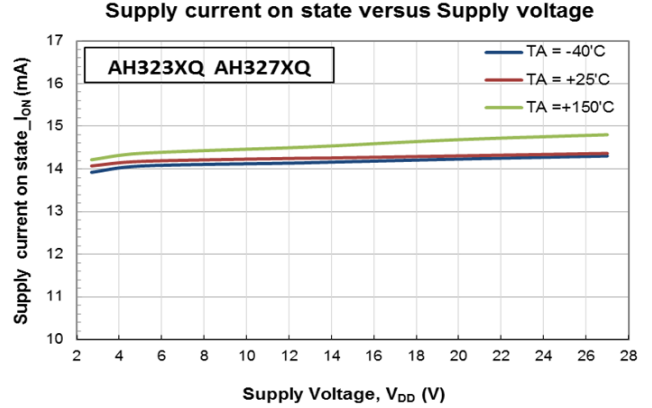
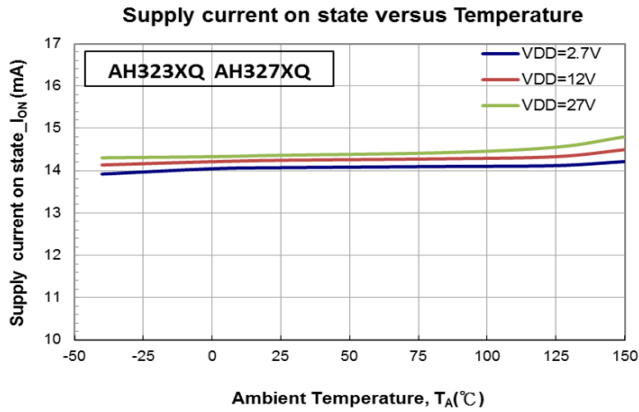

AH323XQ_AH3271Q Supply Current OFF, I_{OFF}(1) Performance

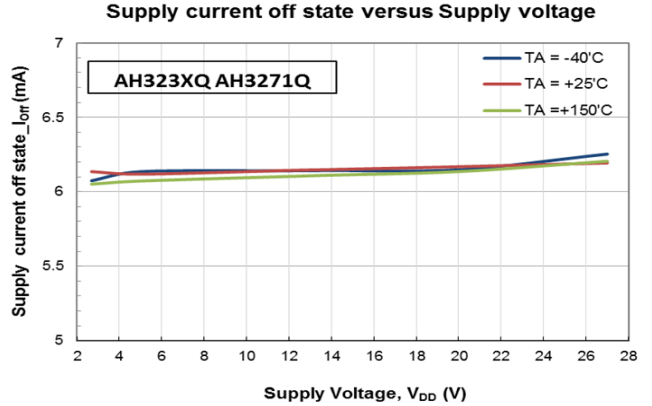
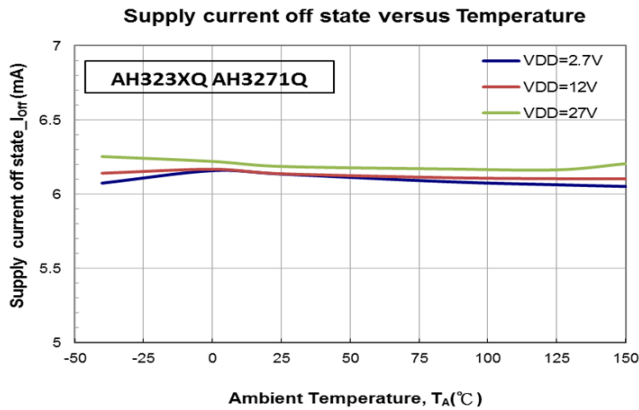

AH3270Q_AH3272Q Supply Current OFF, I_{OFF}(2) Performance

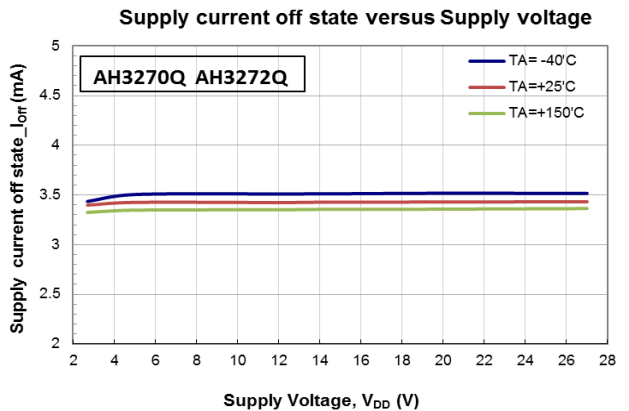
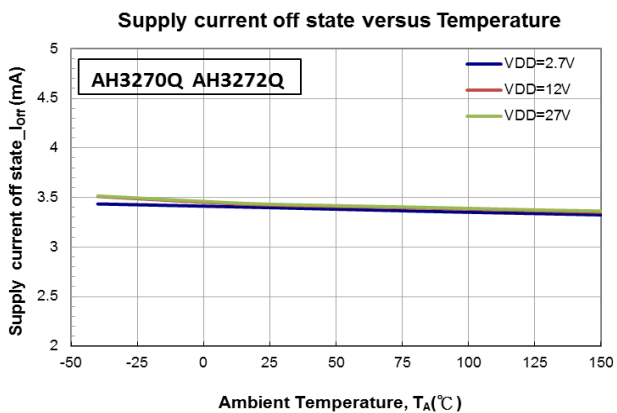

Typical Operating Characteristics (continued)

AH3231Q Magnetic Characteristics Performance

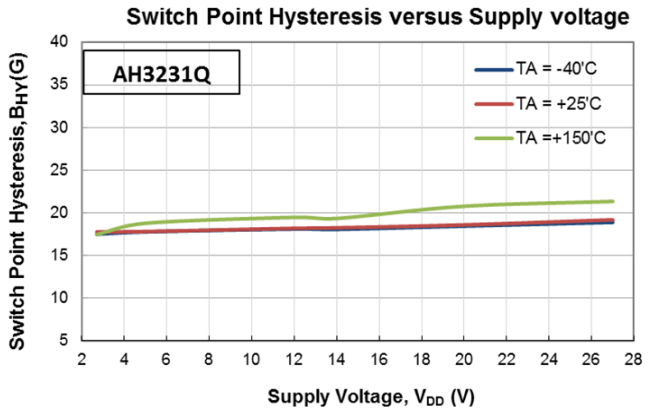
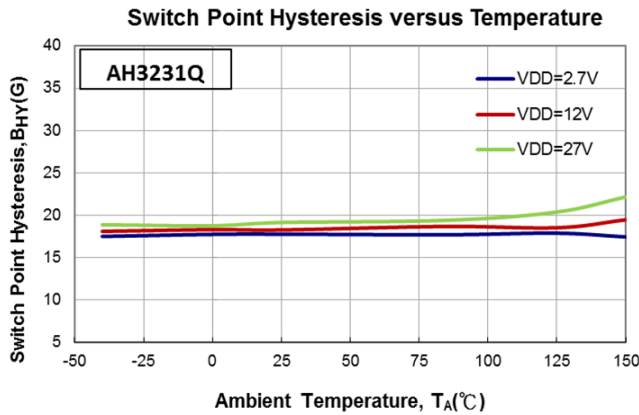
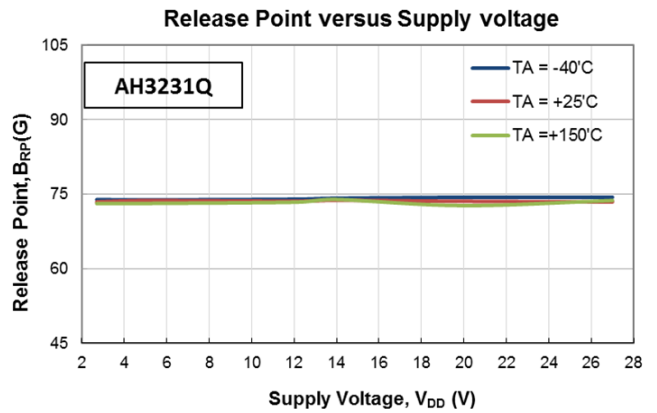
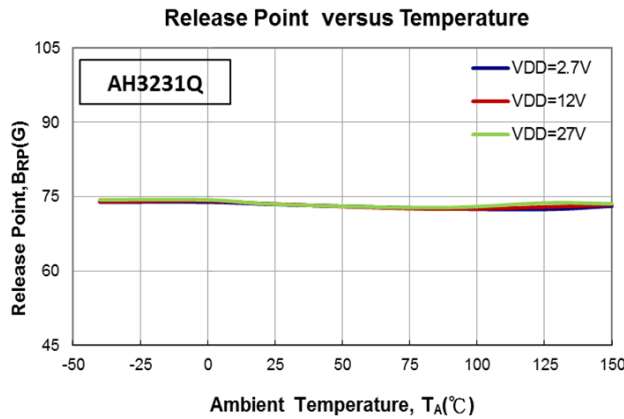
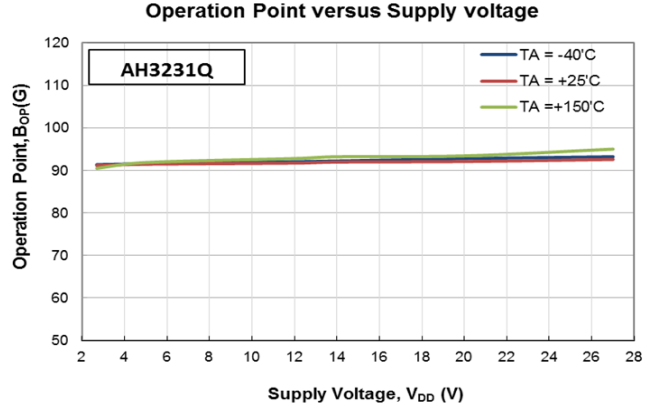
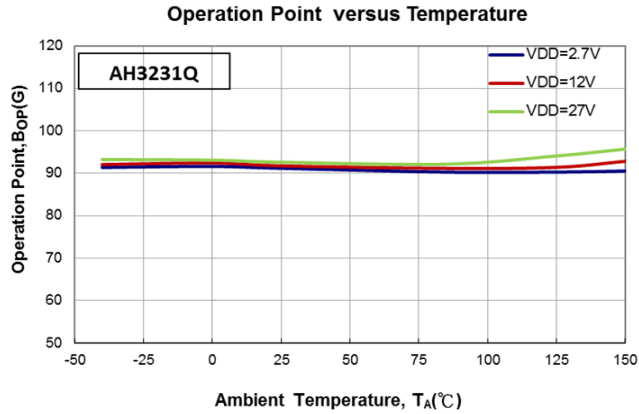

Typical Operating Characteristics (continued)

AH3232Q Magnetic Characteristics Performance

Operation Point versus Temperature

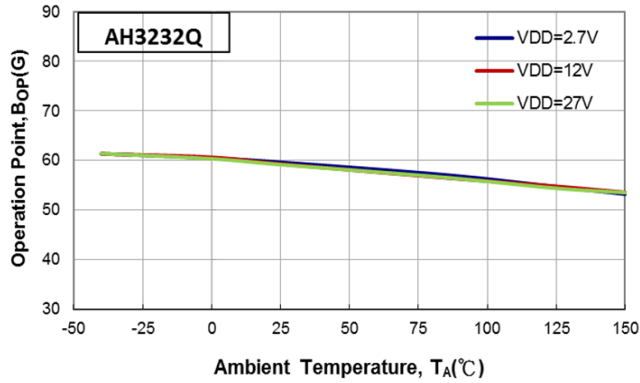

Operation Point versus Supply voltage

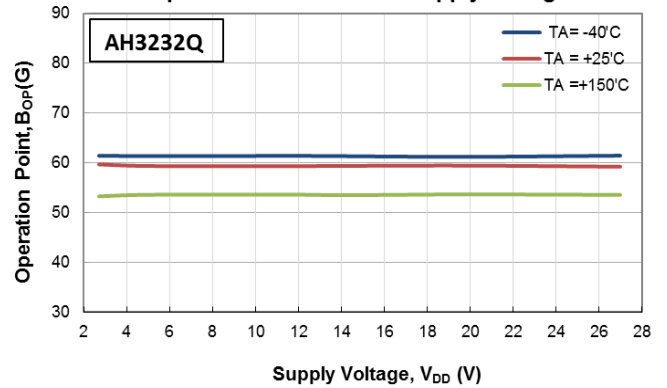

Release Point versus Temperature

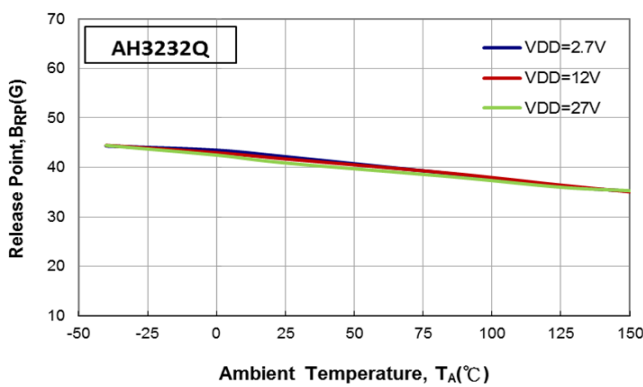

Release Point versus Supply voltage

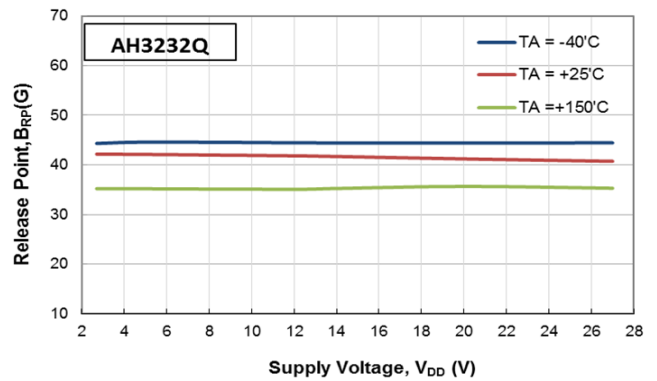

Switch Point Hysteresis versus Temperature

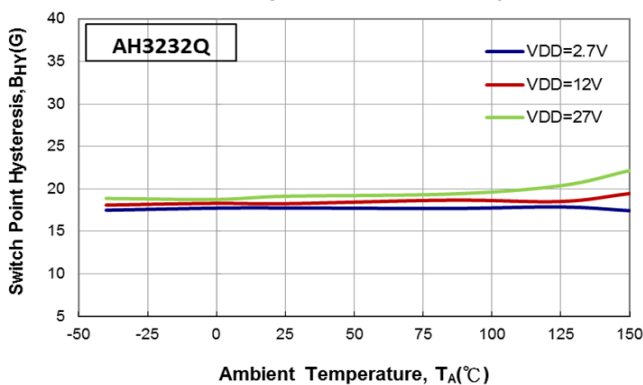

Switch Point Hysteresis versus Supply voltage

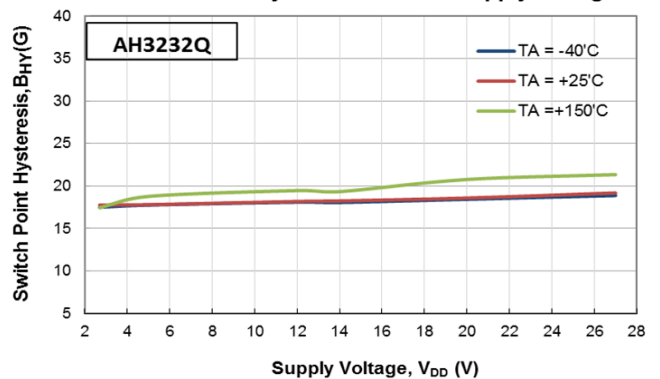

Typical Operating Characteristics (continued)

AH3233Q_AH3234Q Magnetic Characteristics Performance

Operation Point versus Temperature

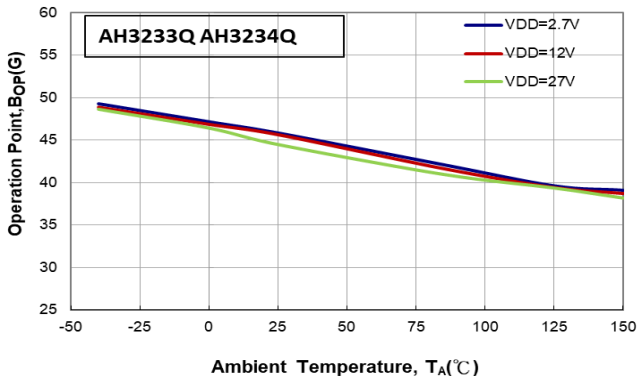

Operation Point versus Supply voltage

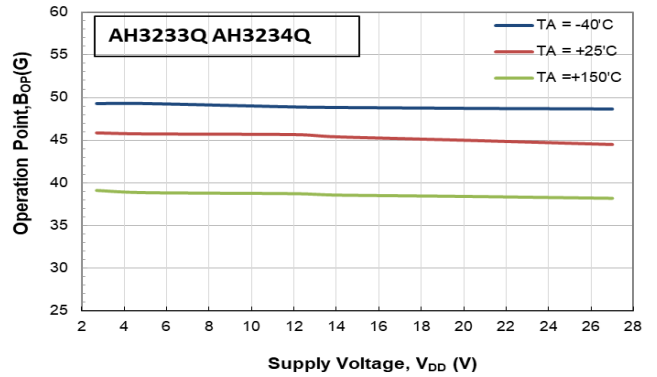

Release Point versus Temperature

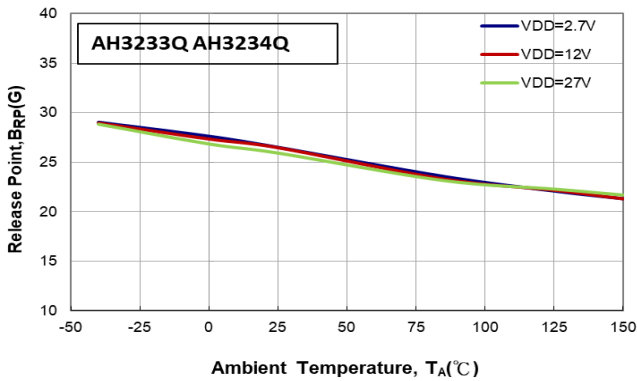

Release Point versus Supply voltage

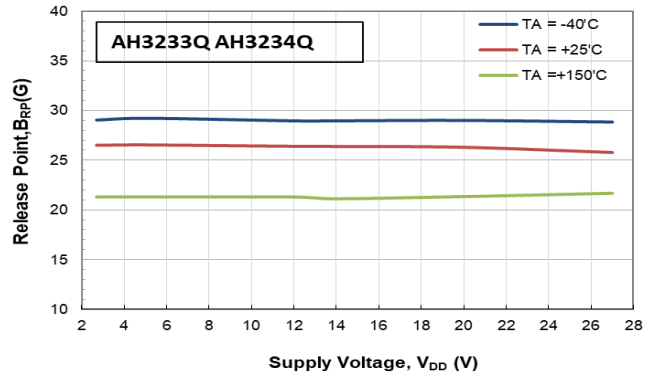

Switch Point Hysteresis versus Temperature

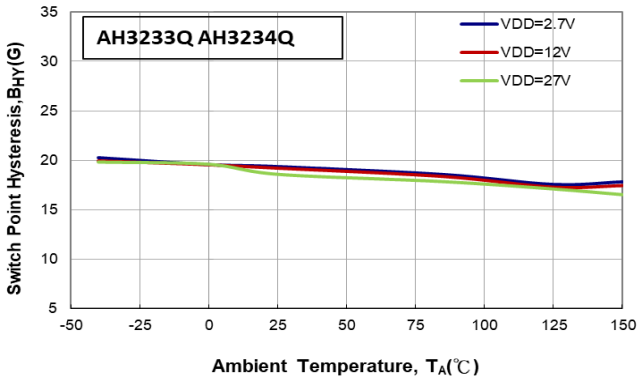

Switch Point Hysteresis versus Supply voltage

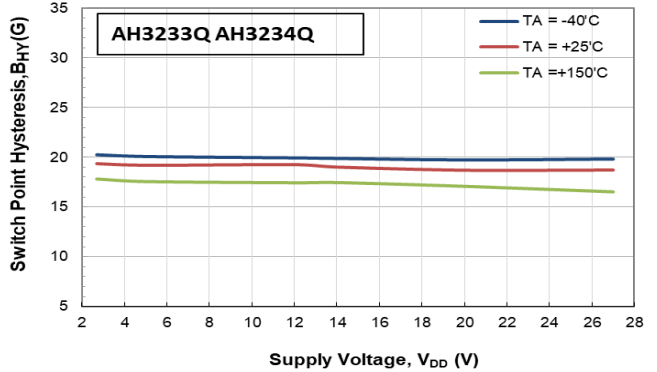

Typical Operating Characteristics (continued)

AH3270Q_AH3271Q Magnetic Characteristics Performance

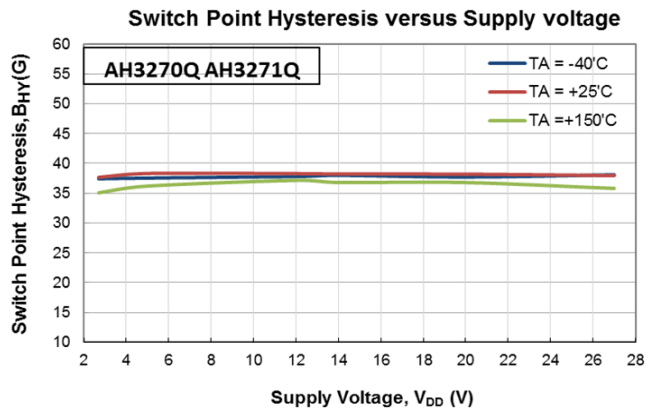
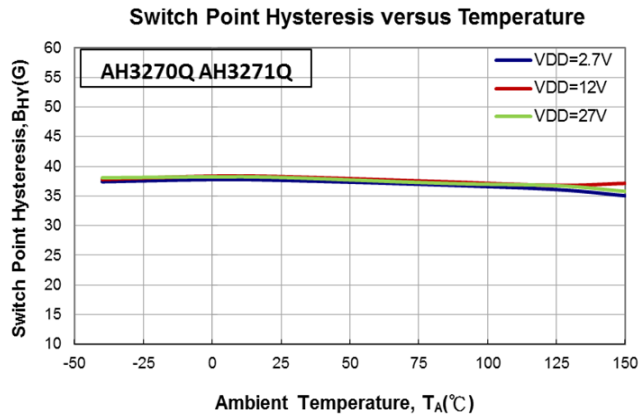
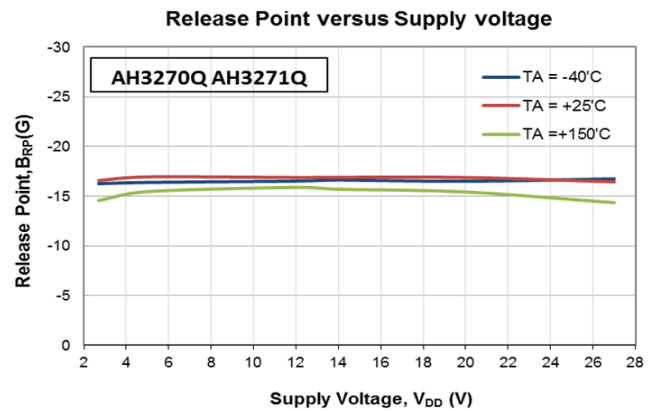
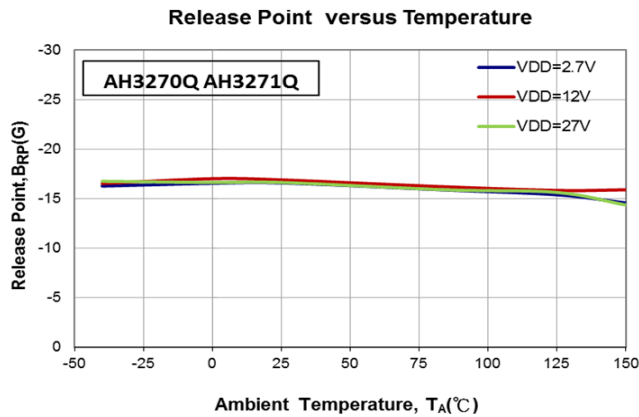
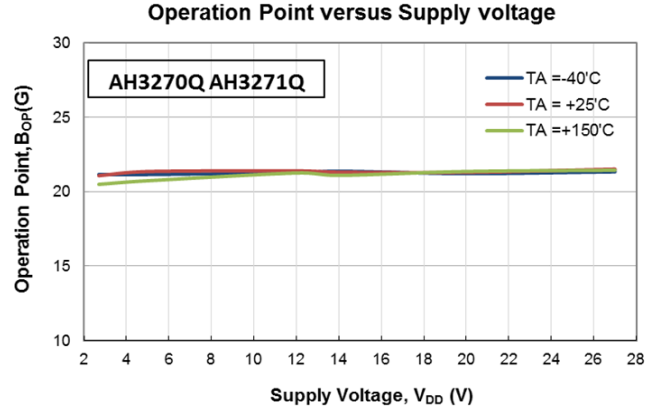
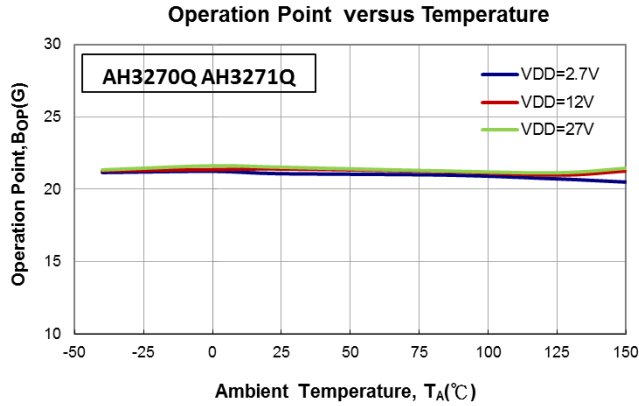

Typical Operating Characteristics (continued)

AH3272Q Magnetic Characteristics Performance

Operation Point versus Temperature

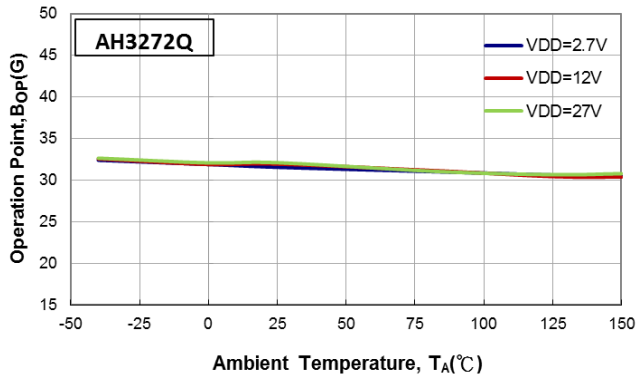

Operation Point versus Supply voltage

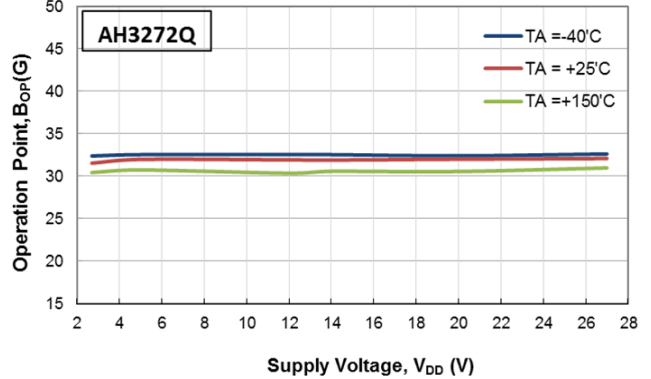

Release Point versus Temperature

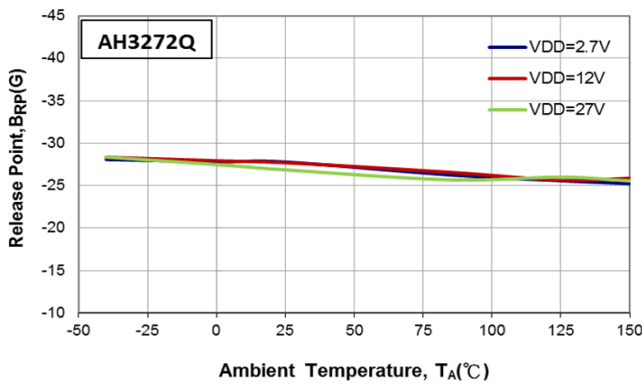

Release Point versus Supply voltage

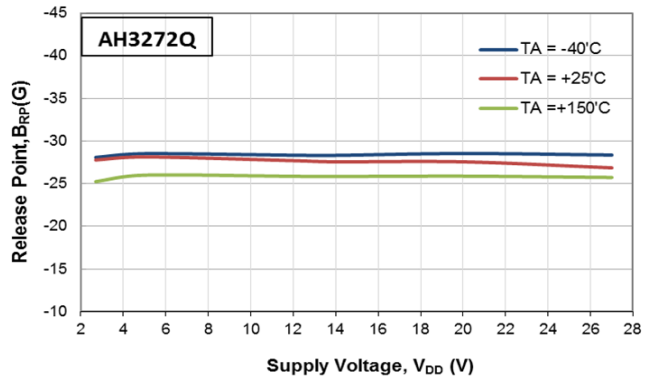

Switch Point Hysteresis versus Temperature

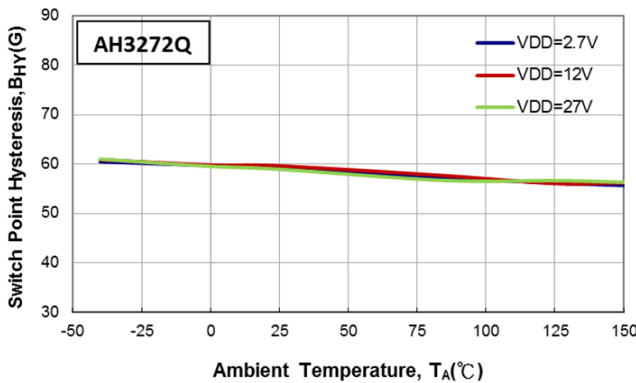

Switch Point Hysteresis versus Supply voltage

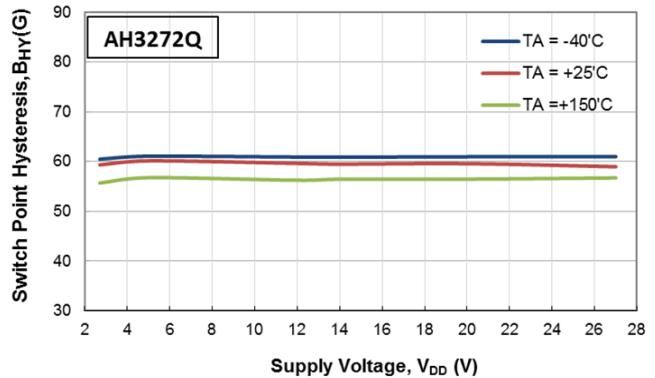

Thermal Performance Characteristics

Symbol	Parameter	Conditions	Rating	Unit
$R_{\theta JA}$	Package Thermal Resistance	SC59, 50mm*50mm 2oz MRB PCB, single layer	268	°C/W
		SIP-3, 50mm*50mm 2oz MRB PCB, single layer	143	°C/W

Thermal Derating Curve vs. Ambient Temperature

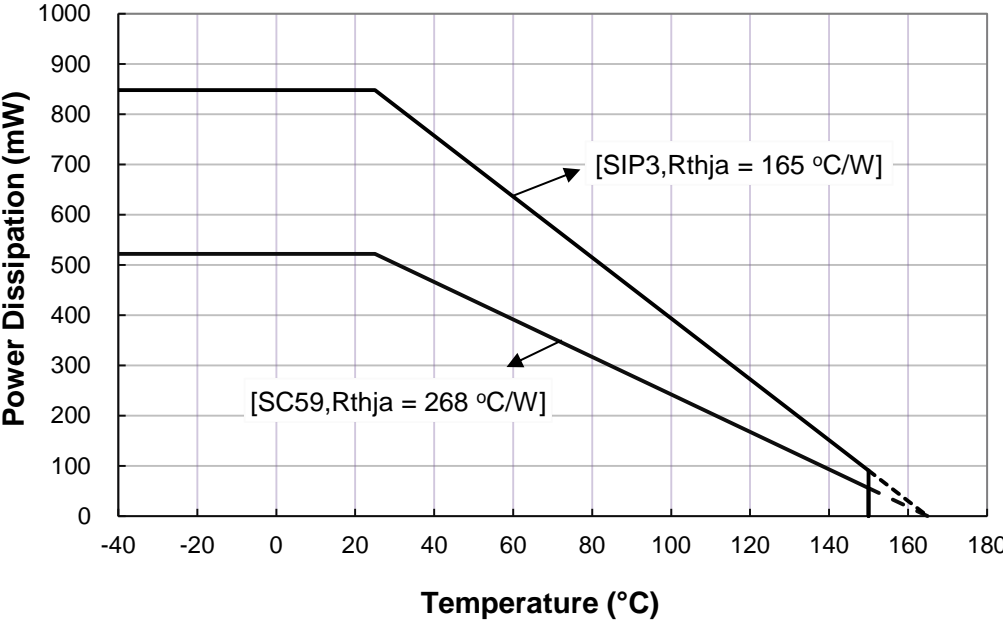

Power Derating Curve

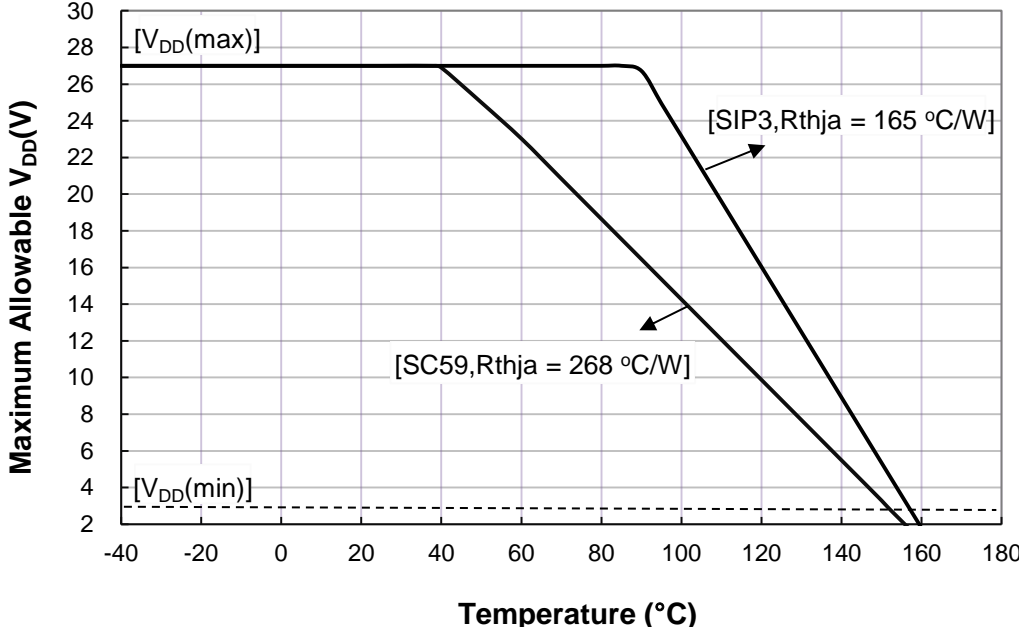

Ordering Information

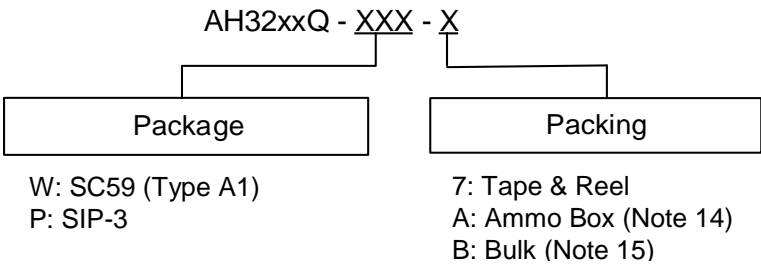

Part Number	Package Code	Packaging	Bulk Box		7" Tape and Reel		Ammo Box	
			Quantity	Part Number Suffix	Quantity	Part Number Suffix	Quantity	Part Number Suffix
AH3231Q-P-A	P	SIP-3 (Ammo Pack)	NA	NA	NA	NA	4000/Box	-A
AH3231Q-P-B	P	SIP-3 (Bulk Pack)	1000	-B	NA	NA	NA	NA
AH3231Q-W-7	W	SC59 (Type A1)	NA	NA	3000/Tape & Reel	-7	NA	NA
AH3232Q-P-A	P	SIP-3 (Ammo Pack)	NA	NA	NA	NA	4000/Box	-A
AH3232Q-P-B	P	SIP-3 (Bulk Pack)	1000	-B	NA	NA	NA	NA
AH3232Q-W-7	W	SC59 (Type A1)	NA	NA	3000/Tape & Reel	-7	NA	NA
AH3233Q-P-A	P	SIP-3 (Ammo Pack)	NA	NA	NA	NA	4000/Box	-A
AH3233Q-P-B	P	SIP-3 (Bulk Pack)	1000	-B	NA	NA	NA	NA
AH3233Q-W-7	W	SC59 (Type A1)	NA	NA	3000/Tape & Reel	-7	NA	NA
AH3234Q-P-A	P	SIP-3 (Ammo Pack)	NA	NA	NA	NA	4000/Box	-A
AH3234Q-P-B	P	SIP-3 (Bulk Pack)	1000	-B	NA	NA	NA	NA
AH3234Q-W-7	W	SC59 (Type A1)	NA	NA	3000/Tape & Reel	-7	NA	NA
AH3270Q-P-A	P	SIP-3 (Ammo Pack)	NA	NA	NA	NA	4000/Box	-A
AH3270Q-P-B	P	SIP-3 (Bulk Pack)	1000	-B	NA	NA	NA	NA
AH3270Q-W-7	W	SC59 (Type A1)	NA	NA	3000/Tape & Reel	-7	NA	NA
AH3271Q-P-A	P	SIP-3 (Ammo Pack)	NA	NA	NA	NA	4000/Box	-A
AH3271Q-P-B	P	SIP-3 (Bulk Pack)	1000	-B	NA	NA	NA	NA
AH3271Q-W-7	W	SC59 (Type A1)	NA	NA	3000/Tape & Reel	-7	NA	NA
AH3272Q-P-A	P	SIP-3 (Ammo Pack)	NA	NA	NA	NA	4000/Box	-A
AH3272Q-P-B	P	SIP-3 (Bulk Pack)	1000	-B	NA	NA	NA	NA
AH3272Q-W-7	W	SC59 (Type A1)	NA	NA	3000/Tape & Reel	-7	NA	NA

Notes: 14. Ammo Box is for SIP-3 (Ammo Pack) Spread Lead.
15. Bulk is for SIP-3 (Bulk Pack) Straight Lead.

Marking Information

(1) Package Type: SC59 (Type A1)

(Top View)

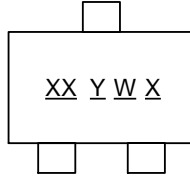

XX : Identification code
Y : Year 0 to 9
W : Week : A to Z : 1 to 26 week;
 a to z : 27 to 52 week; z represents
 52 and 53 week
X : Internal code

Part Number	Package	Identification Code
AH3231Q	SC59 (Type A1)	AT
AH3232Q	SC59 (Type A1)	AR
AH3233Q	SC59 (Type A1)	AV
AH3234Q	SC59 (Type A1)	AX
AH3270Q	SC59 (Type A1)	AW
AH3271Q	SC59 (Type A1)	AU
AH3272Q	SC59 (Type A1)	AS

(2) Package Type: SIP-3 (Ammo Pack), SIP-3 (Bulk Pack)

(Top View)

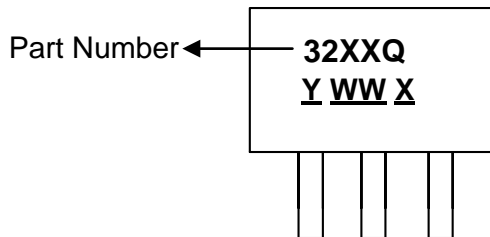

32XXQ : Identification Code
Y : Year : 0~9
WW : Week : 01~52, "52" represents
 52 and 53 week
X : Internal Code

Part Number	Package	Identification Code
AH3231Q	SIP-3 (Ammo Pack)	3231Q
AH3231Q	SIP-3 (Bulk Pack)	3231Q
AH3232Q	SIP-3 (Ammo Pack)	3232Q
AH3232Q	SIP-3 (Bulk Pack)	3232Q
AH3233Q	SIP-3 (Ammo Pack)	3233Q
AH3233Q	SIP-3 (Bulk Pack)	3233Q
AH3234Q	SIP-3 (Ammo Pack)	3234Q
AH3234Q	SIP-3 (Bulk Pack)	3234Q
AH3270Q	SIP-3 (Ammo Pack)	3270Q
AH3270Q	SIP-3 (Bulk Pack)	3270Q
AH3271Q	SIP-3 (Ammo Pack)	3271Q
AH3271Q	SIP-3 (Bulk Pack)	3271Q
AH3272Q	SIP-3 (Ammo Pack)	3272Q
AH3272Q	SIP-3 (Bulk Pack)	3272Q

Package Outline Dimensions (All dimensions in mm.)

Please see <http://www.diodes.com/package-outlines.html> for the latest version.

(1) Package Type: SC59 (Type A1)

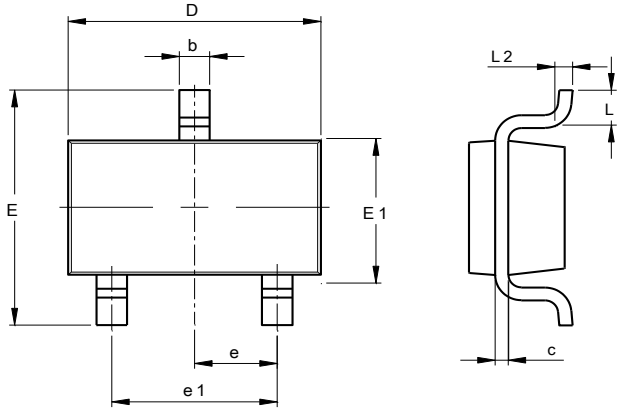

SC59 (Type A1)			
Dim	Min	Max	Typ
A	--	1.45	--
A1	0.00	0.15	--
A2	0.90	1.30	1.15
b	0.30	0.50	--
c	0.08	0.22	--
D	2.90 BSC		
E	2.80 BSC		
E1	1.60 BSC		
e	0.95 BSC		
e1	1.90 BSC		
L	0.30	0.60	0.45
L2	0.25 BSC		
θ1	5°	15°	10°
All Dimensions in mm			

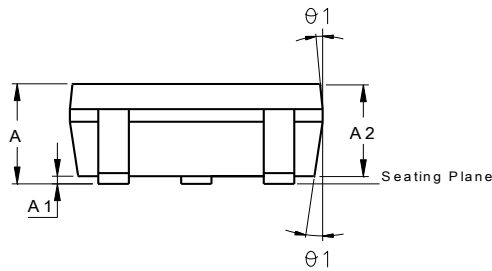

AH32xxQ Hall sensor

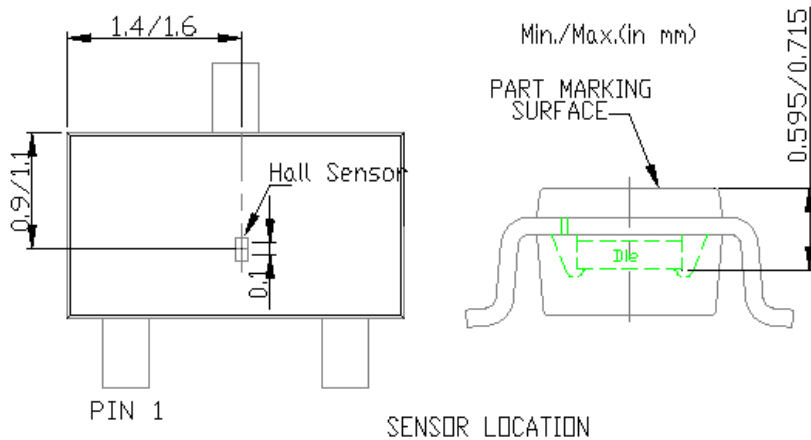

Package Outline Dimensions (continued) (All dimensions in mm.)

Please see <http://www.diodes.com/package-outlines.html> for the latest version.

(2) Package Type: SIP-3 (Bulk Pack)

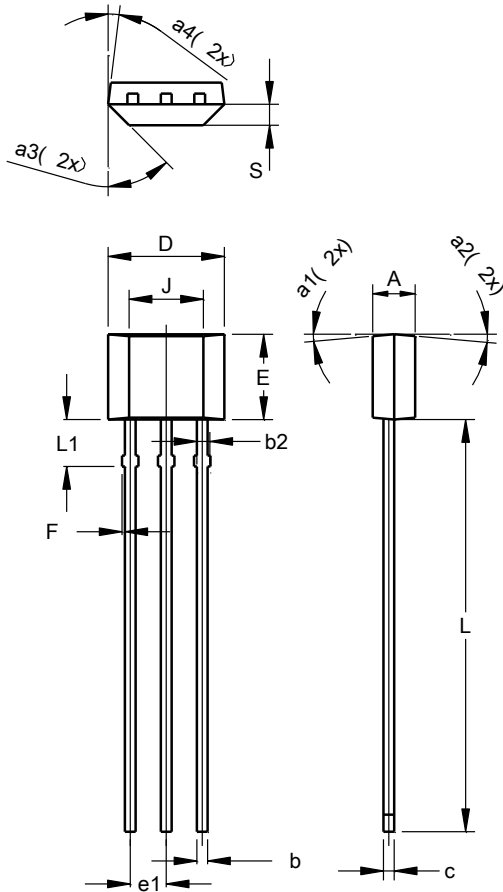

SIP-3 (Bulk Pack)			
Dim	Min	Max	Typ
A	1.40	1.60	1.50
b	0.33	0.43	0.38
b2	0.40	0.508	0.46
c	0.35	0.41	0.38
D	3.90	4.30	4.10
E	2.80	3.20	3.00
e1	1.24	1.30	1.27
F	0.00	0.20	—
J	2.62 REF		
L	14.00	15.00	14.50
L1	1.55	1.75	1.65
S	0.63	0.84	0.74
a1	—	—	5°
a2	—	—	5°
a3	—	—	45°
a4	—	—	3°
All Dimensions in mm			

AH32xxQ SIP3 Hall sensor

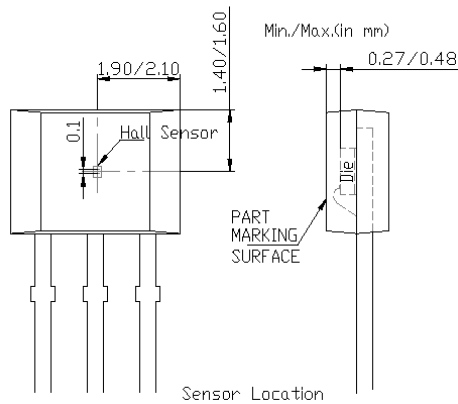

Package Outline Dimensions (continued) (All dimensions in mm.)

Please see <http://www.diodes.com/package-outlines.html> for the latest version.

(3) Package Type: SIP-3 (Ammo Pack)

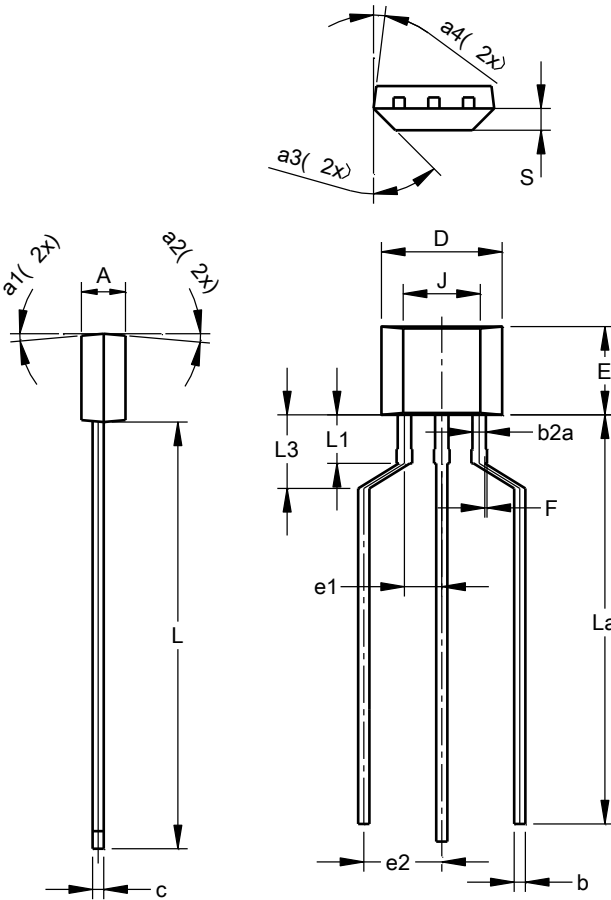

SIP-3 (Ammo Pack)			
Dim	Min	Max	Typ
A	1.40	1.60	1.50
b	0.33	0.43	0.38
b2a	0.40	0.52	0.46
c	0.35	0.41	0.38
D	3.90	4.30	4.10
E	2.80	3.20	3.00
e1	1.24	1.30	1.27
e2	2.40	2.90	2.65
F	0.00	0.20	—
J	2.62 REF		
L	14.00	15.00	14.50
La	12.90	14.90	13.90
L1	1.55	1.75	1.65
L3	2.00	3.00	2.50
S	0.63	0.84	0.74
a1	—	—	5°
a2	—	—	5°
a3	—	—	45°
a4	—	—	3°
All Dimensions in mm			

AH32xxQ SIP3 Hall sensor

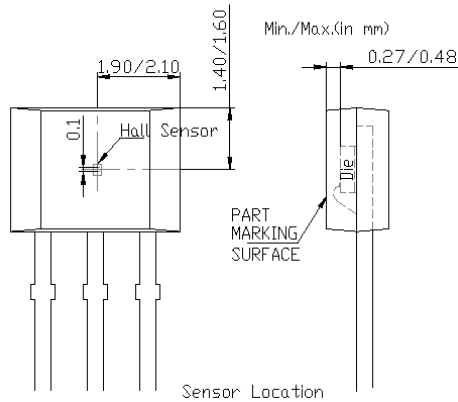

Suggested Pad Layout

Please see <http://www.diodes.com/package-outlines.html> for the latest version.

(1) Package Type: SC59 (Type A1)

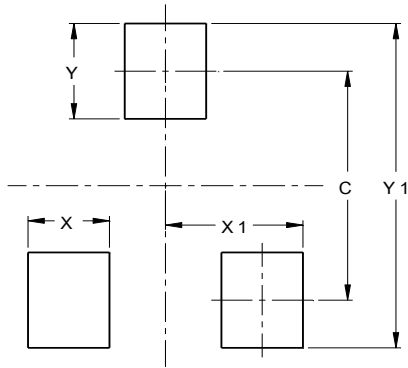

Dimensions	Value (in mm)
C	2.40
X	0.80
X1	1.35
Y	1.00
Y1	3.40

IMPORTANT NOTICE

1. DIODES INCORPORATED (Diodes) AND ITS SUBSIDIARIES MAKE NO WARRANTY OF ANY KIND, EXPRESS OR IMPLIED, WITH REGARDS TO ANY INFORMATION CONTAINED IN THIS DOCUMENT, INCLUDING, BUT NOT LIMITED TO, THE IMPLIED WARRANTIES OF MERCHANTABILITY, FITNESS FOR A PARTICULAR PURPOSE OR NON-INFRINGEMENT OF THIRD PARTY INTELLECTUAL PROPERTY RIGHTS (AND THEIR EQUIVALENTS UNDER THE LAWS OF ANY JURISDICTION).
2. The Information contained herein is for informational purpose only and is provided only to illustrate the operation of Diodes' products described herein and application examples. Diodes does not assume any liability arising out of the application or use of this document or any product described herein. This document is intended for skilled and technically trained engineering customers and users who design with Diodes' products. Diodes' products may be used to facilitate safety-related applications; however, in all instances customers and users are responsible for (a) selecting the appropriate Diodes products for their applications, (b) evaluating the suitability of Diodes' products for their intended applications, (c) ensuring their applications, which incorporate Diodes' products, comply the applicable legal and regulatory requirements as well as safety and functional-safety related standards, and (d) ensuring they design with appropriate safeguards (including testing, validation, quality control techniques, redundancy, malfunction prevention, and appropriate treatment for aging degradation) to minimize the risks associated with their applications.
3. Diodes assumes no liability for any application-related information, support, assistance or feedback that may be provided by Diodes from time to time. Any customer or user of this document or products described herein will assume all risks and liabilities associated with such use, and will hold Diodes and all companies whose products are represented herein or on Diodes' websites, harmless against all damages and liabilities.
4. Products described herein may be covered by one or more United States, international or foreign patents and pending patent applications. Product names and markings noted herein may also be covered by one or more United States, international or foreign trademarks and trademark applications. Diodes does not convey any license under any of its intellectual property rights or the rights of any third parties (including third parties whose products and services may be described in this document or on Diodes' website) under this document.
5. Diodes' products are provided subject to Diodes' Standard Terms and Conditions of Sale (<https://www.diodes.com/about/company/terms-and-conditions/terms-and-conditions-of-sales/>) or other applicable terms. This document does not alter or expand the applicable warranties provided by Diodes. Diodes does not warrant or accept any liability whatsoever in respect of any products purchased through unauthorized sales channel.
6. Diodes' products and technology may not be used for or incorporated into any products or systems whose manufacture, use or sale is prohibited under any applicable laws and regulations. Should customers or users use Diodes' products in contravention of any applicable laws or regulations, or for any unintended or unauthorized application, customers and users will (a) be solely responsible for any damages, losses or penalties arising in connection therewith or as a result thereof, and (b) indemnify and hold Diodes and its representatives and agents harmless against any and all claims, damages, expenses, and attorney fees arising out of, directly or indirectly, any claim relating to any noncompliance with the applicable laws and regulations, as well as any unintended or unauthorized application.
7. While efforts have been made to ensure the information contained in this document is accurate, complete and current, it may contain technical inaccuracies, omissions and typographical errors. Diodes does not warrant that information contained in this document is error-free and Diodes is under no obligation to update or otherwise correct this information. Notwithstanding the foregoing, Diodes reserves the right to make modifications, enhancements, improvements, corrections or other changes without further notice to this document and any product described herein. This document is written in English but may be translated into multiple languages for reference. Only the English version of this document is the final and determinative format released by Diodes.
8. Any unauthorized copying, modification, distribution, transmission, display or other use of this document (or any portion hereof) is prohibited. Diodes assumes no responsibility for any losses incurred by the customers or users or any third parties arising from any such unauthorized use.
9. This Notice may be periodically updated with the most recent version available at <https://www.diodes.com/about/company/terms-and-conditions/important-notice>

DIODES is a trademark of Diodes Incorporated in the United States and other countries.
The Diodes logo is a registered trademark of Diodes Incorporated in the United States and other countries.
© 2022 Diodes Incorporated. All Rights Reserved.

www.diodes.com