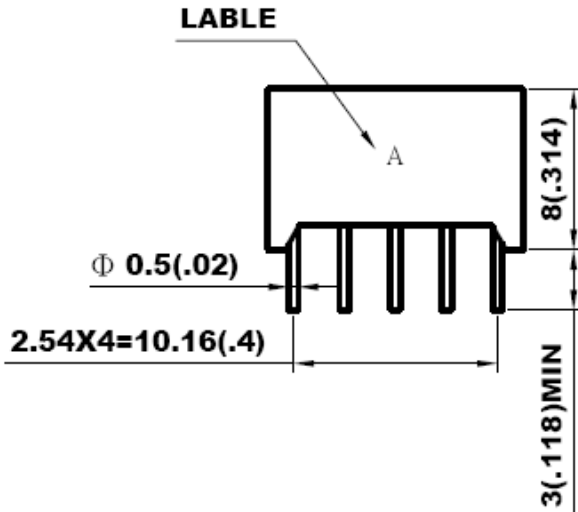
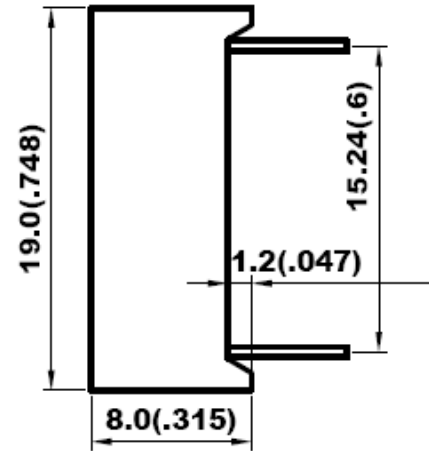
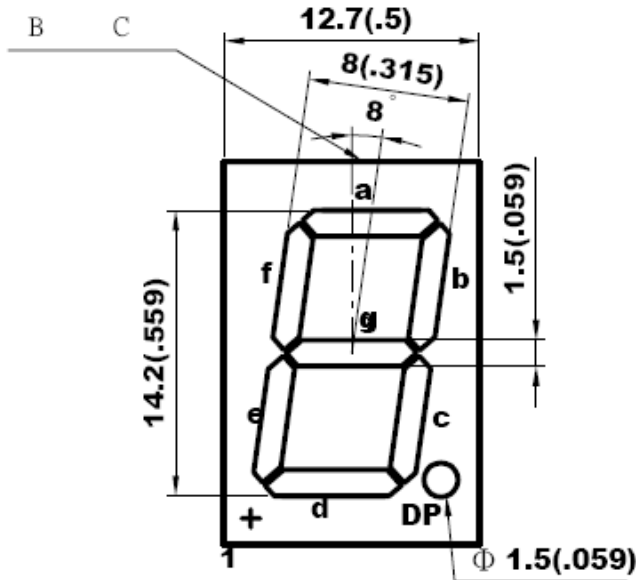
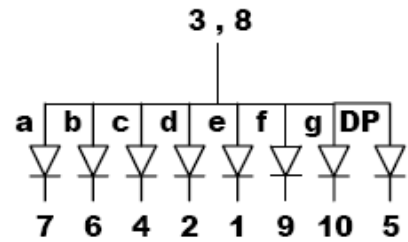
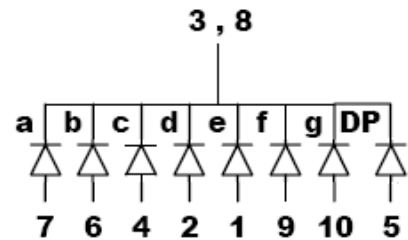

SPECIFICATIONS **CDSX56F SERIES**
PACKAGE DIMENSIONS

CDSA56F SERIES

CDSC56F SERIES

Notes:

1. All dimensions are in millimeters (inches).
2. Tolerance is $\pm 0.25\text{mm}$ (0.01") unless otherwise noted.
3. Specifications are subject to change without notice.



ChromeLED Corp. reserves the right to make changes at any time in order to supply the best product possible. The most current version of this document will always be available at: www.chromeled.com

PART NUMBER DESCRIPTION

Part Number	Chip Material	Color of Emission	Lens Type	Description
CDSA56R1WF	GaAsP	Red	White Segment	Common Anode
CDSC56R1WF	GaAsP	Red	White Segment	Common Cathode
CDSA56RR1WF	AlGaAs	Super Red	White Segment	Common Anode
CDSC56RR1WF	AlGaAs	Super Red	White Segment	Common Cathode
CDSA56Y1WF	GaAsP	Yellow	White Segment	Common Anode
CDSC56Y1WF	GaAsP	Yellow	White Segment	Common Cathode
CDSA56G1WF	GaP	Green	White Segment	Common Anode
CDSC56G1WF	GaP	Green	White Segment	Common Cathode
CDSA56B1WF	GaN	Blue	White Segment	Common Anode
CDSC56B1WF	GaN	Blue	White Segment	Common Cathode

OPTICAL-ELECTRICAL CHARACTERISTICS
(TA=25°C)

Part Number	Wave-length (nm)	Absolute Maximum				Electro-Optical Characteristics					
		$\Delta\lambda$	P _D	I _{AF}	I _{PF}	V _F (V)			I _F	I _v (mcd)	
		nm	mW	mA	(Peak)	Min	Typ	Max	(Rec)	Min	Typ
CDSA56R1WF	625	45	75	30	100	1.7	1.85	2.5	10	3	8
CDSC56R1WF	625	45	75	30	100	1.7	1.85	2.5	10	3	8
CDSA56RR1WF	640	20	72	20	100	1.6	1.75	2.4	10	5	18
CDSC56RR1WF	640	20	72	20	100	1.6	1.75	2.4	10	5	18
CDSA56Y1WF	588	35	75	30	100	1.7	2.1	2.8	10	1.9	4.7
CDSC56Y1WF	588	35	75	30	100	1.7	2.1	2.8	10	1.9	4.7
CDSA56G1WF	568	30	65	30	100	1.7	2.1	2.8	10	3	10.5
CDSC56G1WF	568	30	65	30	100	1.7	2.1	2.8	10	3	10.5
CDSA56B1WF	470	30	120	30	100	3.0	3.5	4.0	10	1.9	8.5
CDSC56B1WF	470	30	120	30	100	3.0	3.5	4.0	10	1.9	8.5



ChromeLED Corp. reserves the right to make changes at any time in order to supply the best product possible. The most current version of this document will always be available at: www.chromeled.com

ABSOLUTE MAXIMUM RATINGS (TA=25°C)

Reverse Voltage	5V	Spectral Line half-width (λ)	nm
Reverse Current (Vr = 5V)	100 μ A	Power Dissipation (Pd)	mW
Operating Temperature	-40°C~+85°C	Peak Forward Current (Duty 1/10, @ KHz)	mA
Storage Temperature	-40°C~+85°C	Recommended Operation Current (If Rec)	mA
Soldering Temperature	250C~260C for 3 sec.	Average Luminous Intensity (If=10)	μ A



ChromeLED Corp. reserves the right to make changes at any time in order to supply the best product possible. The most current version of this document will always be available at: www.chromeled.com

OPTICAL CHARACTERISTIC CURVES - RED

Forward Current vs. Forward Voltage

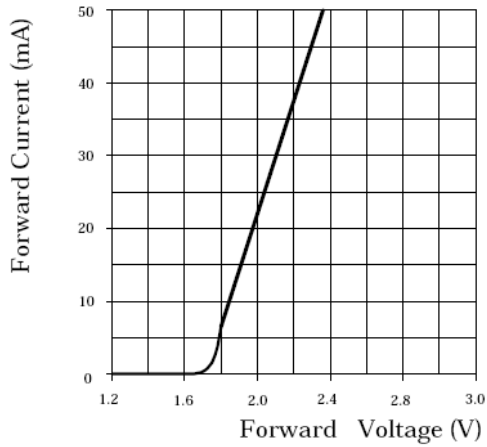

Relative Intensity vs. Forward Current

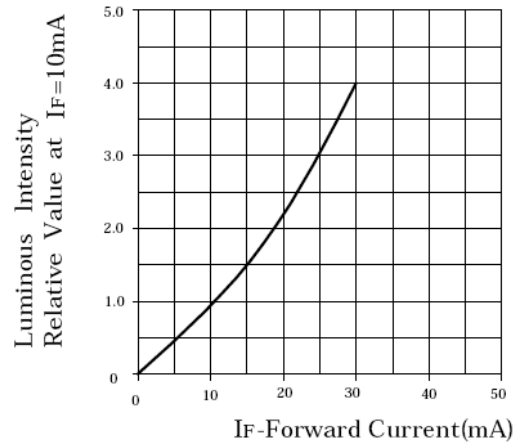

Forward Current vs. Ambient Temperature

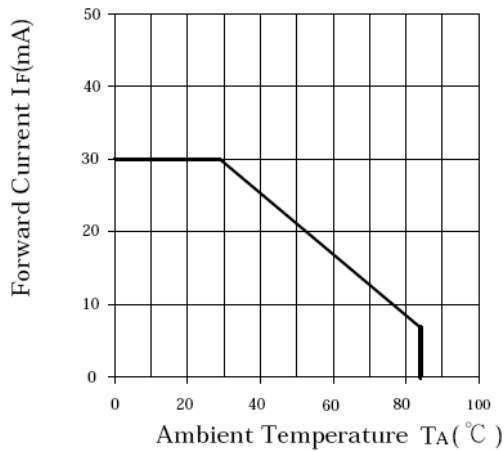

Luminous Intensity vs. Ambient Temperature

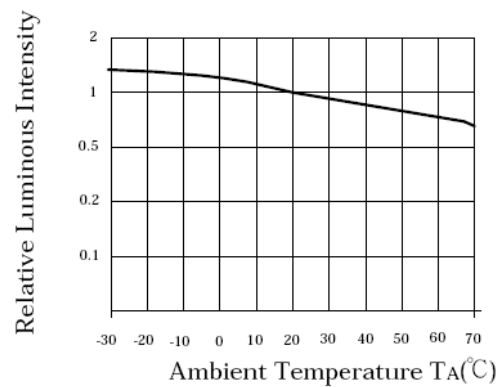

ChromeLED Corp. reserves the right to make changes at any time in order to supply the best product possible. The most current version of this document will always be available at: www.chromeled.com

OPTICAL CHARACTERISTIC CURVES - SUPER RED

Forward Current vs. Forward Voltage

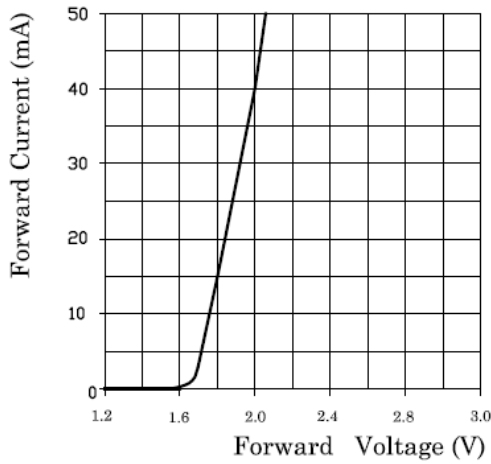

Relative Intensity vs. Forward Current

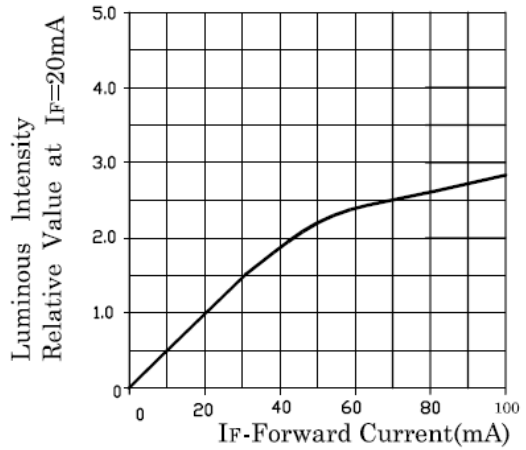

Forward Current vs. Ambient Temperature

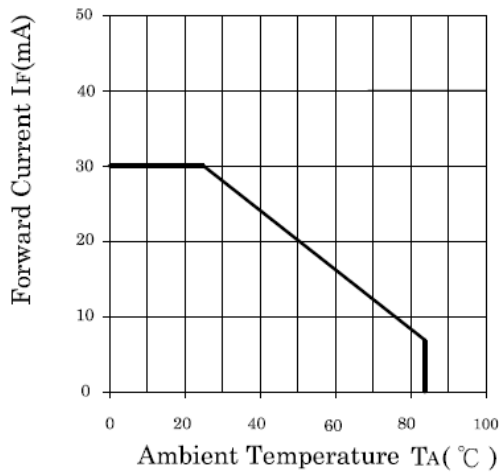

Luminous Intensity vs. Ambient Temperature

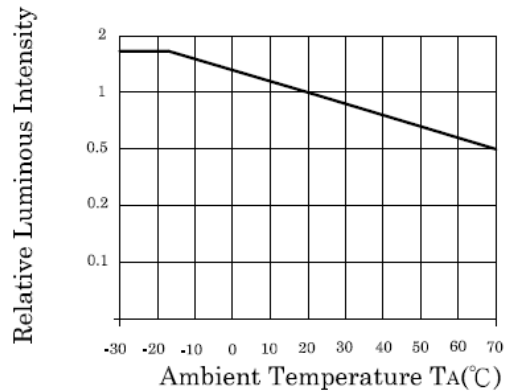

ChromeLED Corp. reserves the right to make changes at any time in order to supply the best product possible. The most current version of this document will always be available at: www.chromeled.com

OPTICAL CHARACTERISTIC CURVES - YELLOW

Forward Current vs. Forward Voltage

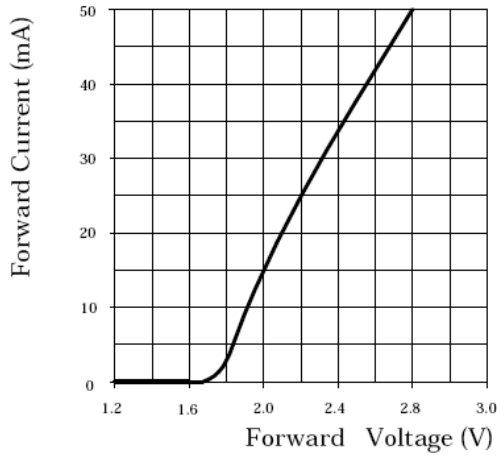

Relative Intensity vs. Forward Current

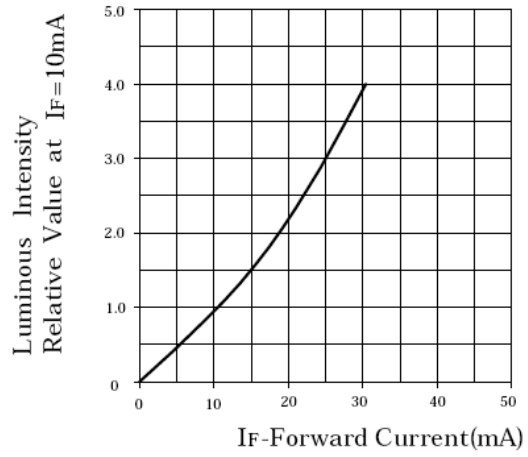

Forward Current vs. Ambient Temperature

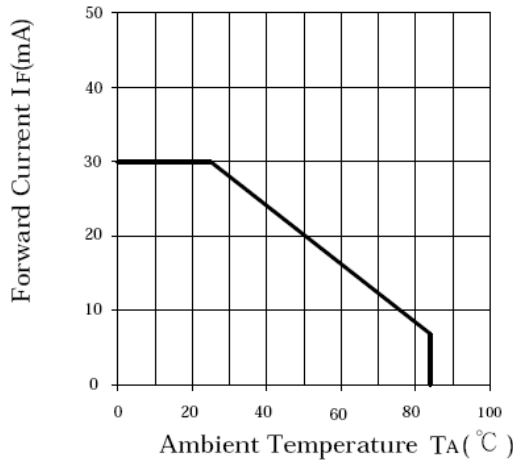

Luminous Intensity vs. Ambient Temperature

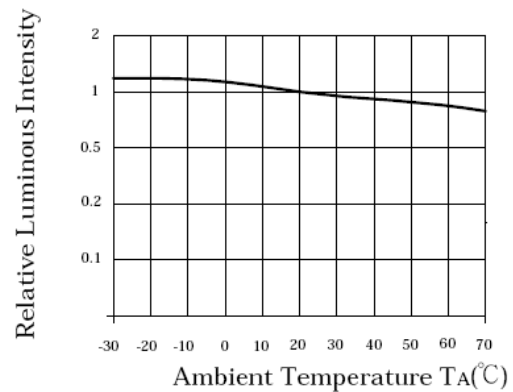

ChromeLED Corp. reserves the right to make changes at any time in order to supply the best product possible. The most current version of this document will always be available at: www.chromeled.com

OPTICAL CHARACTERISTIC CURVES - GREEN

Forward Current vs. Forward Voltage

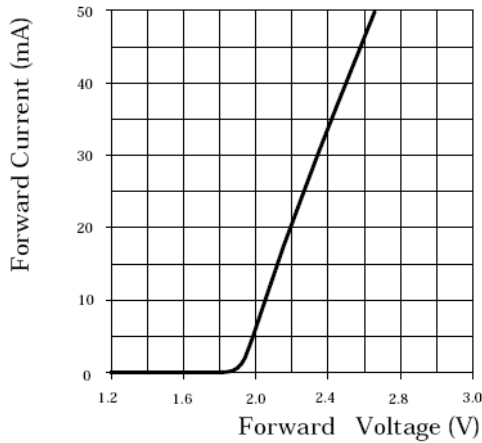

Relative Intensity vs. Forward Current

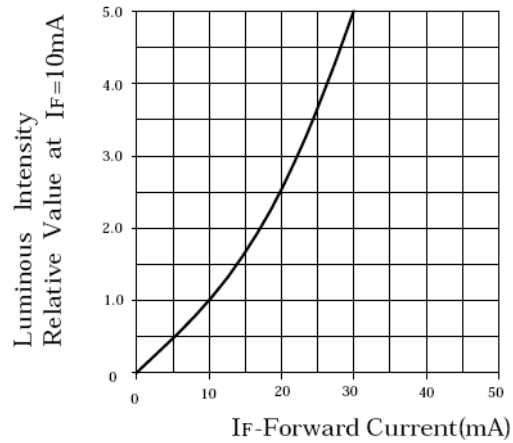

Forward Current vs. Ambient Temperature

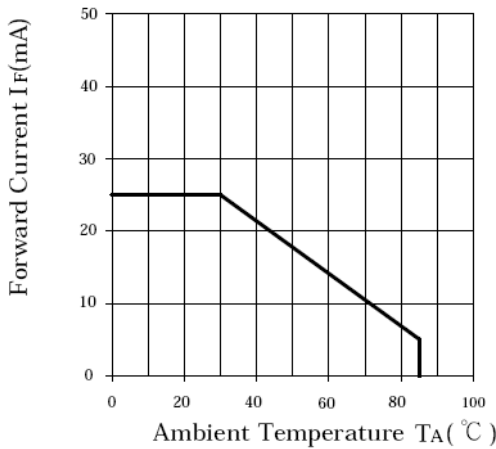

Luminous Intensity vs. Ambient Temperature

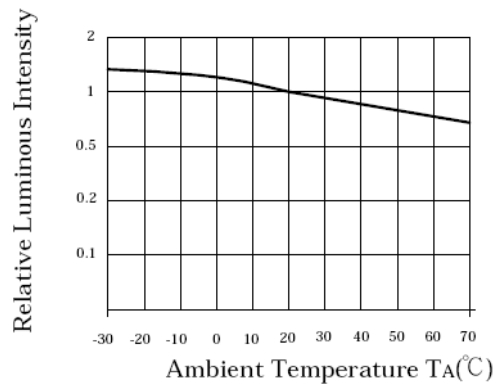

ChromeLED Corp. reserves the right to make changes at any time in order to supply the best product possible. The most current version of this document will always be available at: www.chromeled.com

OPTICAL CHARACTERISTIC CURVES - BLUE

Forward Current vs. Forward Voltage

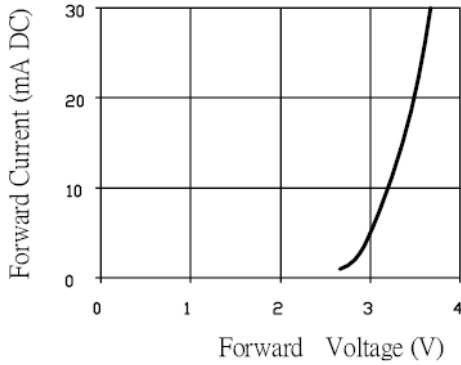

Relative Intensity vs. Forward Current

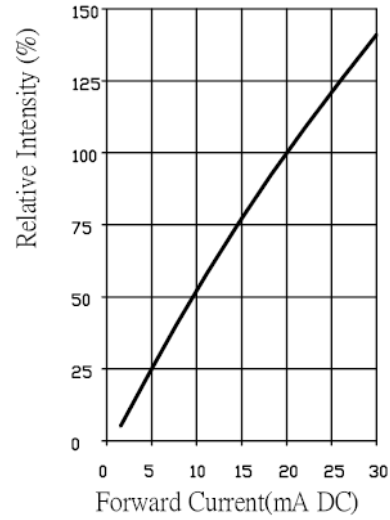

Forward Current vs. Ambient Temperature

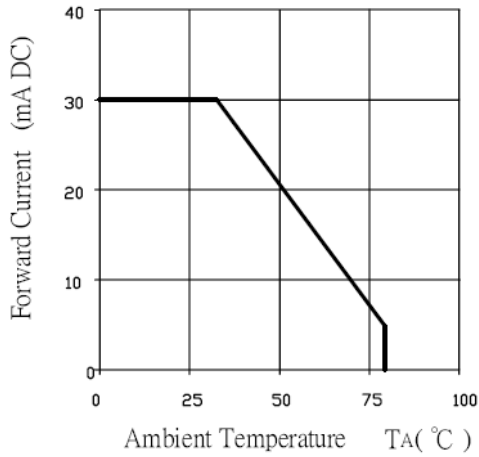

Luminous Intensity vs. Ambient Temperature

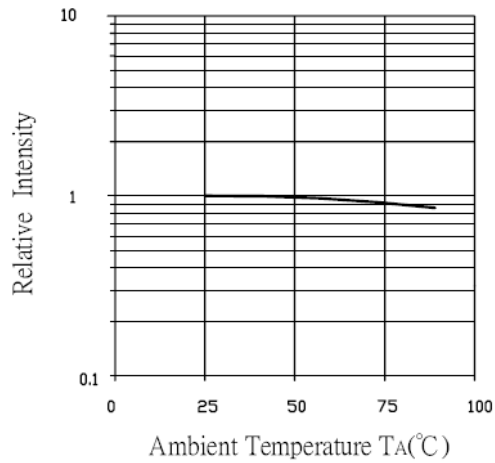

ChromeLED Corp. reserves the right to make changes at any time in order to supply the best product possible. The most current version of this document will always be available at: www.chromeled.com

SOLDERING CONDITIONS - DISPLAY

* Solder the LED no closer than 3mm from the base of the epoxy bulb. Soldering beyond the base of the tie bar is recommended.

* Recommended soldering conditions

Dip Soldering	
Pre-Heat	100 °C Max
Pre-Heat Time	60 Second Max
Solder Bath Temperature	260 °C Max
Dipping Time	5 Second Max
Dipping Position	No lower than 3mm from the base of the epoxy

Hand Soldering		
	3mm Series	Others
Temperature Soldering Time Position	300 °C Max 3 Second Max No closer than 3mm from the base of the epoxy	350 °C Max 3 Second Max No closer than 3mm from the base of the epoxy

* Do not apply any stress to the lead. Particularly when heated.

* The LED must not be repositioned after soldering.

* After soldering the LEDs, the epoxy bulb should be protected from mechanical shock or vibration until the LEDs return to room temperature.

* Direct soldering onto a PC board should be avoided. Mechanical stress to the resin may be caused by the PC board warping or from the clinching and cutting of the leadframes. When it is absolutely necessary, the LEDs may be mounted in this fashion, but, the user will assume responsibility for any problems. Direct soldering should only be done after testing has confirmed that no damage, such as wire bond failure or resin deterioration, will occur. LEDs should not be soldered directly to double sided PC boards because the heat will deteriorate the epoxy resin.

* When it is necessary to clamp the LEDs to prevent soldering failure, it is important to minimize the mechanical stress on the LEDs.

* Cut the LED leadframes at room temperature. Cutting the leadframes at high temperature may cause LED failure.



ChromeLED Corp. reserves the right to make changes at any time in order to supply the best product possible. The most current version of this document will always be available at: www.chromeled.com