

Electrical Characteristics

Part Number	Inductance (nH)	Offset Value (nH)	Tolerance (±%)	Test Frequency (MHz)	SRF (MHz) Min	RDC (Ω) Max	Irms (mA) Max
BWLM0011070618N□00	18	-0.9	5	100	3000	0.046	1400
BWLM0011070633N□00	33	-0.9	5	100	1800	0.065	1300
BWLM0011070648N□00	48	-1.5	5	100	1400	0.078	1100
BWLM0011070670N□00	70	-1.8	5	100	1300	0.12	820
BWLM0011070696N□00	96	-1.1	5	100	1100	0.16	730
BWLM00110706R13□00	130	-5.0	5	100	1000	0.23	640
BWLM00110706R16□00	160	-2.6	5	100	900	0.33	480
BWLM00110706R20□00	200	-6.0	5	100	800	0.47	390

Note: When ordering, please specify tolerance code. Tolerance : J=±5%

- Operating temperature range - 40°C ~ 125°C(Including self - temperature rise)
- I_{rms} for a 20°C temperature rise from 25°C ambient with current
- Measure Equipment :
 L & Q : Agilent E4991A+Agilent HP16197A
 SRF : Agilent E4991A
 RDC : HP4338B or Chroma 16502
 I_{rms} : HP4284A+HP42841A/HP4285A+HP42841A

Test Instruments : Agilent E4991A Material/Impedance Analyzer

Typical L vs. Frequency

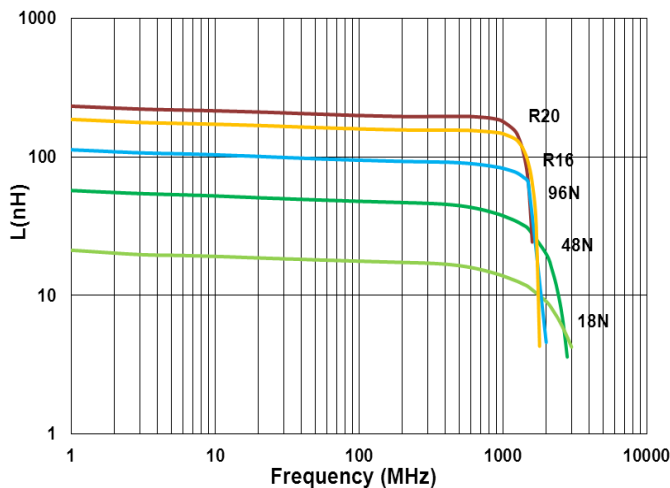

Typical Q vs. Frequency

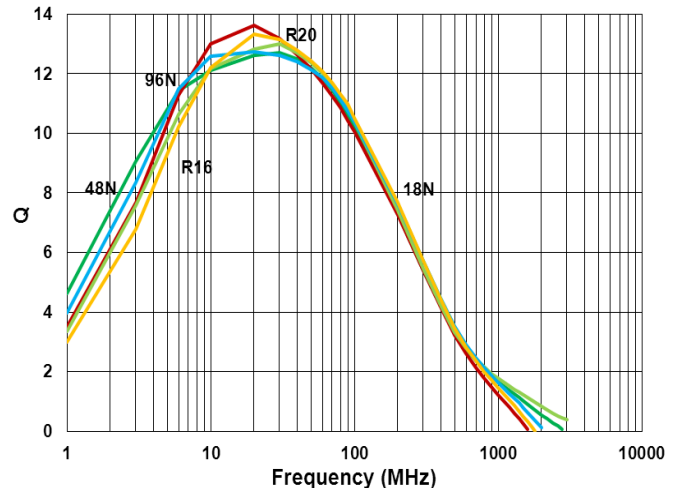

Electrical Characteristics

Part Number	Inductance (nH)	Offset Value (nH)	Tolerance (±%)	Test Frequency (MHz)	SRF (MHz) Min	RDC (Ω) Max	Irms (mA) Max
BWLM001810094N7□00	4.9	-0.8	±0.5nH	10	2300	0.015	2600
BWLM0018100915N□00	15	-1.2	5	10	2000	0.025	2200
BWLM0018100933N□00	33	-2.3	5	10	1800	0.035	1700
BWLM0018100955N□00	55	-3.9	5	10	1600	0.045	1500
BWLM0018100985N□00	85	-5.4	5	10	1380	0.060	1400
BWLM00181009R10□00	100	-10.7	10	10	1260	0.10	1000
BWLM00181009R12□00	120	-6.6	5	10	1200	0.085	1100
BWLM00181009R16□00	160	-7.0	5	10	900	0.10	1000
BWLM00181009R21□00	210	-12.3	5	10	720	0.15	800
BWLM00181009R27□00	270	-10.9	5	10	660	0.16	750
BWLM00181009R33□00	330	-13.4	5	10	600	0.25	630
BWLM00181009R39□00	390	-14.5	5	10	570	0.28	620
BWLM00181009R47□00	470	-19.5	5	10	555	0.45	500
BWLM00181009R56□00	560	-25	5	10	540	0.48	450
BWLM00181009R65□00	650	-25	5	10	510	0.52	430

Note: When ordering, please specify tolerance code. Tolerance : D=±0.5nH , J=±5% , K=±10%

- Operating temperature range - 40°C ~ 125°C(Including self - temperature rise)
- Irms for a 20°C temperature rise from 25°C ambient with current
- Measure Equipment :
 L & Q : Agilent E4991A+Agilent HP16197A
 SRF : Agilent E4991A
 RDC : HP4338B or Chroma 16502
 Irms : HP4284A+HP42841A/HP4285A+HP42841A

Test Instruments : Agilent E4991A Material/Impedance Analyzer

Typical **L** vs. **F** Frequency

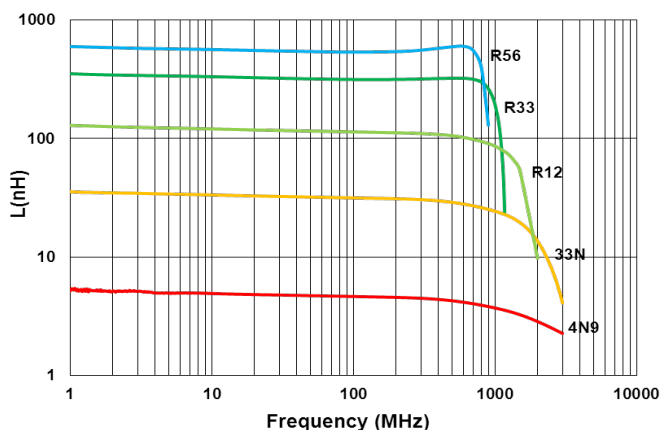

Typical **Q** vs. **F** Frequency

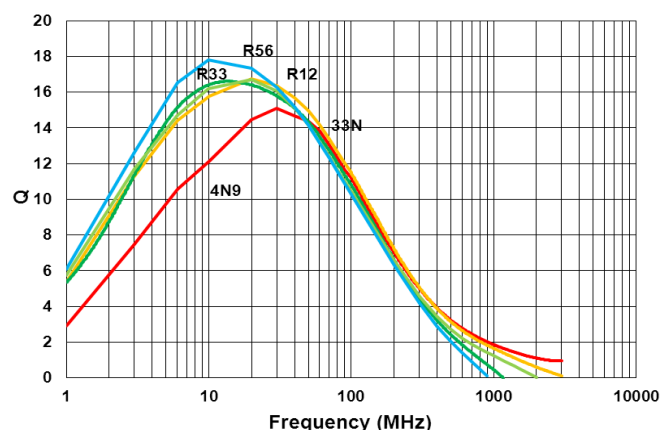

Packaging Specifications

Tape Dimensions

Figure 1

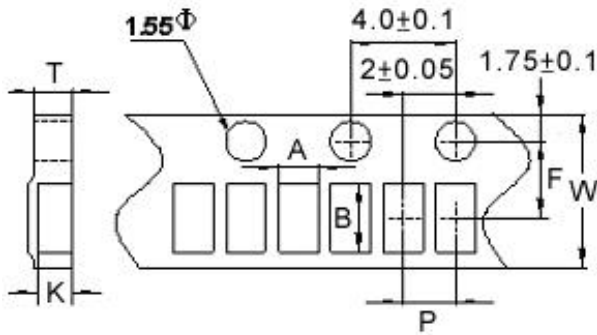

Tape Material

Carrier Tape: Paper
Cover Tape: Polystyrene

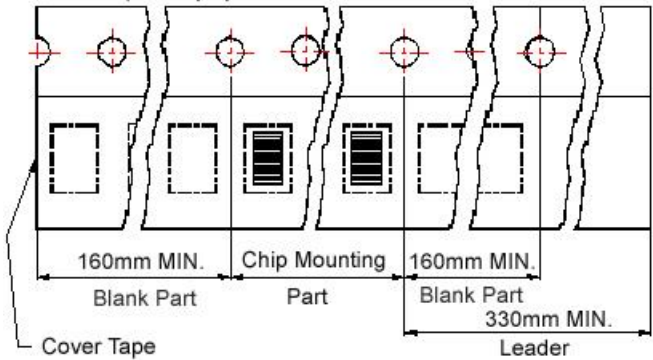
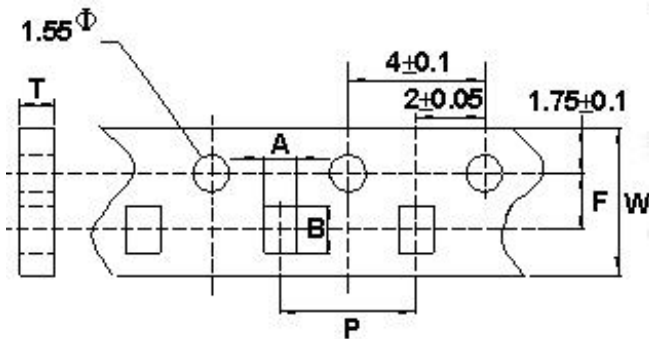
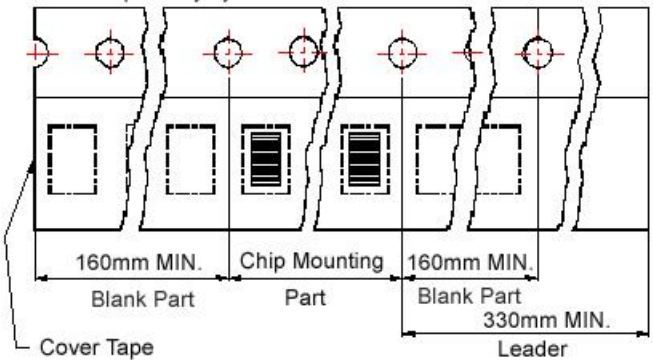

Figure 2



Carrier Tape: Paper
Cover Tape: Polystyrene



Reel Dimensions

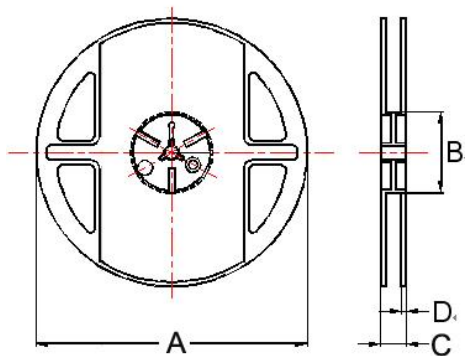

SMD Wire Wound Ferrite Chip Inductors

BWLM Series



Dimensions in mm

TYPE	Fig.	Tape Dimensions							Reel Dimensions				Quantity
		A	B	T	W	P	F	K	A	B	C	D	PCS / REEL
BWLM00110706	1	0.8	1.2	0.75	8	2	3.5	0.62	178	60	12	1.5	4000
BWLM00181009	2	1.2	2.0	1.1	8	4	3.5	-	178	60	12	1.5	4000

For More Information:

[Americas - prodinfo_power_americas@yageo.com](mailto:prodinfo_power_americas@yageo.com) | [Europe - prodinfo_power_emea@yageo.com](mailto:prodinfo_power_emea@yageo.com) | [Asia - prodinfo_power_asia@yageo.com](mailto:prodinfo_power_asia@yageo.com)

Performance warranty of products offered on this data sheet is limited to the parameters specified. Data is subject to change without notice. Other brand and product names mentioned herein may be trademarks or registered trademarks of their respective owners. © Copyright, 2022. Pulse Electronics, Inc. All rights reserved.