

Aluminum electrolytic capacitors

Axial-lead and soldering star capacitors

Series/Type: B41691, B41791

Date: December 2016

© EPCOS AG 2016. Reproduction, publication and dissemination of this publication, enclosures hereto and the information contained therein without EPCOS' prior express consent is prohibited.

EPCOS AG is a TDK Group Company.

Applications

- Automotive electronics

Features

- High vibration stability, special design with high vibration stability up to 60 g available upon request
- Long useful life, 10000 h at up to 125 °C
- Low ESR also at rated voltage 63 V DC
- High ripple current capability
- SIKOREL design – storage for up to 15 years at a temperature of up to 35 °C
- RoHS-compatible

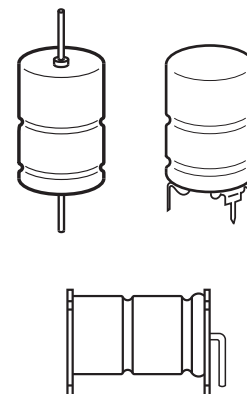

Construction

- Charge/discharge-proof, polar
- Aluminum case with insulating sleeve
- Negative pole connected to case
- Version without insulation available upon request

Terminals

- Axial leads, welded to capacitor case and cover disc
- Soldering star option for upright mounting on PCB
- Alternative axial-lead design with double-sided plates for horizontal mounting available upon request

Taping and packing

- Axial-lead capacitors will be delivered in pallet package
Capacitors with $d \times l \leq 16 \times 39$ mm are also available taped on reel
- Soldering star capacitors are packed in blister trays

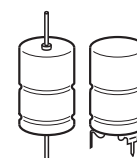

Specifications and characteristics in brief

Rated voltage V_R	25 ... 63 V DC							
Surge voltage V_S	$1.15 \cdot V_R$							
Rated capacitance C_R	220 ... 4000 μF							
Capacitance tolerance	–10/+30% \triangleq Q							
Leakage current I_{leak} (5 min, 20 °C)	$I_{\text{leak}} \leq 0.006 \mu\text{A} \cdot \left(\frac{C_R}{\mu\text{F}} \cdot \frac{V_R}{\text{V}} \right) + 4 \mu\text{A}$							
Self-inductance ESL ¹⁾	Diameter d (mm)	12	14	16	18	20	21	
	Terminals	Length l (mm)						Approx. ESL (nH)
	axial	25	–	22	26	30	–	–
		29	–	–	–	–	38	–
		30	21	24	29	34	–	39
		35	–	–	31	36	–	41
		39	–	–	33	38	–	45
	soldering star	49	–	–	–	–	–	50
		25	–	6	7	8	–	–
		30	6	7	8	10	–	11
35		–	–	9	10.5	–	12	
39		–	–	9	11	–	13	
49	–	–	–	–	–	14		
Useful life ²⁾	Requirements:							
150 °C; V_R ; $0.5 \cdot I_{AC,R}$	> 2000 h	$ \Delta C/C \leq 30\%$ of initial value						
125 °C; V_R ; $I_{AC,max}$	> 4000 h	ESR ≤ 3 times initial specified limit ³⁾						
125 °C; V_R ; $I_{AC,R}$	> 10000 h	$I_{\text{leak}} \leq$ initial specified limit						
105 °C; V_R ; $I_{AC,max}$	> 8000 h							
85 °C; V_R ; $I_{AC,max}$	> 15000 h							
Voltage endurance test	125 °C; V_R							
	5000 h for $V_R \leq 40$ V DC 3000 h for $V_R = 63$ V DC							
Post test requirements	$ \Delta C/C \leq 10\%$ of initial value ESR ≤ 1.3 times initial specified limit ³⁾ $I_{\text{leak}} \leq$ initial specified limit							
Vibration resistance test	To IEC 60068-2-6, test Fc: Frequency range 10 Hz ... 2 kHz, displacement amplitude max. 1.5 mm, acceleration max. 20 g, duration 3×2 h. Capacitor mounted by its wire leads at a distance of (6 ± 1) mm from the case and additionally clamped by the case.							
IEC climatic category	To IEC 60068-1: 55/125/56 (–55 °C/+125 °C/56 days damp heat test)							
Detail specification	Similar to CECC 30301-802							
Sectional specification	IEC 60384-4							

1) If optimum circuit design is used, the values are lower by 30%.

2) Refer to chapter "General technical information, 5 Useful life" on how to interpret useful life.

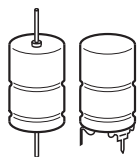
3) ESR_{max} at 100 Hz, 20 °C



B41691, B41791

Low ESR – up to 150 °C

B41691, Axial-lead capacitors

Dimensional drawing

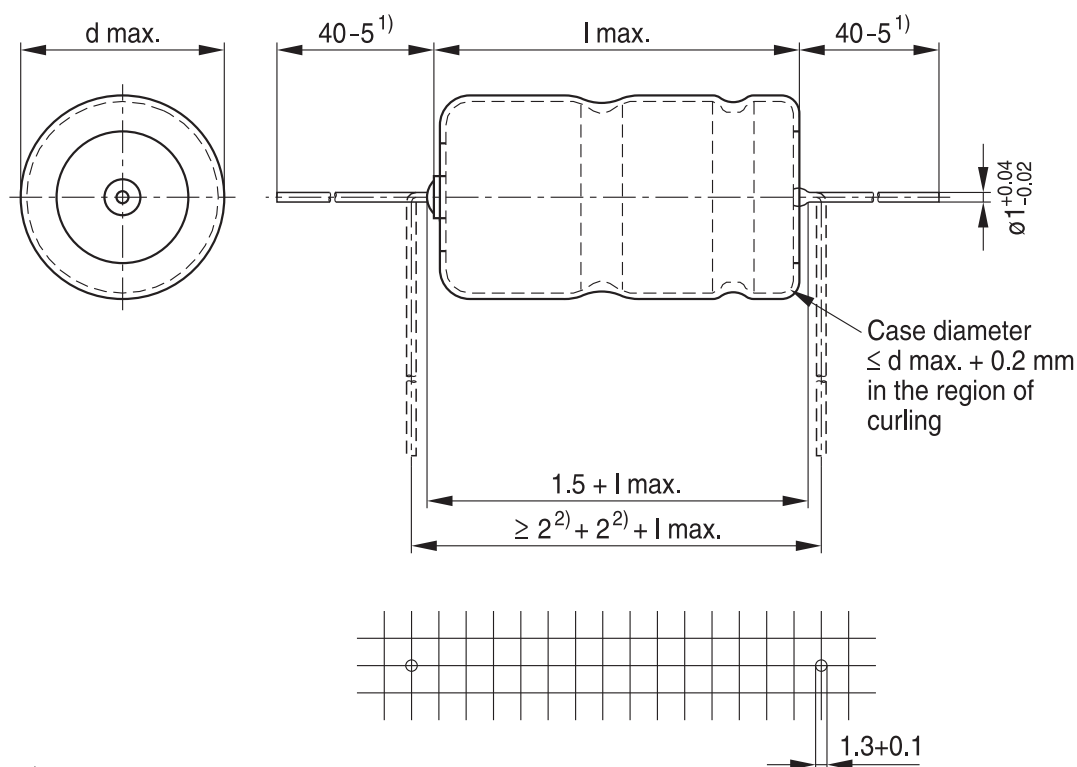

1) For d = 21 mm: 35-5

2) Minimum 2 mm bending distance per wire recommended

KAL1655-Y-E

Dimensions, weights and packing units

d × l mm	d _{max} × l _{max} mm	Approx. weight g	Packing units (pcs.)	
			Pallet	Reel
12 × 30	12.5 × 30.5	5.1	288	450
14 × 25	14.5 × 25.5	5.7	200	350
14 × 30	14.5 × 30.5	6.8	200	350
16 × 25	16.5 × 25.5	7.4	180	250
16 × 30	16.5 × 30.5	8.9	180	250
16 × 35	16.5 × 35.5	10.4	180	250
16 × 39	16.5 × 40	11.7	180	250
18 × 25	18.5 × 25.5	9.3	160	—
18 × 30	18.5 × 30.5	11.1	160	—
18 × 35	18.5 × 35.5	12.8	160	—
18 × 39	18.5 × 40	14.7	160	—
20 × 29	20.5 × 29.5	13.5	140	—
21 × 30	21.5 × 30.5	16.5	140	—
21 × 35	21.5 × 35.5	17.0	140	—
21 × 39	21.5 × 40	20.0	140	—
21 × 49	21.5 × 50	25.0	110	—

B41791, Soldering star capacitors
Dimensional drawings

 Mounting holes $d = 12 \text{ mm} \dots 14 \text{ mm}$

 Mounting holes $d = 16 \text{ mm} \dots 21 \text{ mm}$

Dimensions, weights and packing units

$d \times l$ mm	$d_{\max} \times l_{\max}$ mm	$c \pm 0.1$ mm	$e \pm 0.1$ mm	Approx. weight g	Packing units pcs.
12 × 30	13.5 × 32	12.5	3.0	5.4	480
14 × 25	15.5 × 27	14.5	3.0	6.1	480
14 × 30	15.5 × 32	14.5	3.0	7.2	480
16 × 30	17.5 × 32	16.5	3.0	9.4	300
16 × 25	17.5 × 27	16.5	3.0	7.9	300
16 × 35	17.5 × 37	16.5	3.0	10.9	200
16 × 39	17.5 × 41.5	16.5	3.0	12.2	200
18 × 25	19.5 × 27	18.5	3.0	9.9	300
18 × 30	19.5 × 32	18.5	3.0	11.8	300
18 × 35	19.5 × 37	18.5	3.0	13.2	200
18 × 39	19.5 × 41.5	18.5	3.0	15.4	200
21 × 30	22.5 × 32	21.5	3.5	17.1	468
21 × 35	22.5 × 37	21.5	3.5	18.3	324
21 × 39	22.5 × 41.5	21.5	3.5	21.0	324
21 × 49	22.5 × 51.5	21.5	3.5	26.0	264



B41691, B41791

Low ESR – up to 150 °C

Overview of available types

V_R (V DC)	25	40	63
	Case dimensions $d \times l$ (mm)		
C_R (μF)			
220			12 × 30
240			14 × 25
330	12 × 30	12 × 30	14 × 30
360			16 × 25
430			18 × 25
470	14 × 25	14 × 30	16 × 30
560			16 × 35
620			18 × 30
680		16 × 30 18 × 25	16 × 39
750			18 × 35
820		16 × 35	21 × 30
910			18 × 39
1000	16 × 30 18 × 25	16 × 39 18 × 30	21 × 35
1200		20 × 29	
1300			21 × 39
1500	16 × 39 18 × 30	18 × 39	
1600			21 × 49
1800	20 × 29		
2000	18 × 39		
2200		21 × 39	
2700		21 × 49	
3000	21 × 39		
4000	21 × 49		

Case dimensions and ordering codes

C_R 100 Hz 20 °C μF	Case dimensions $d \times l$ mm	Ordering code Axial pallet	Ordering code Axial reel	Ordering code Soldering star
$V_R = 25 \text{ V DC}$				
330	12 × 30	B41691A5337Q001	B41691A5337Q003	B41791A5337Q001
470	14 × 25	B41691A5477Q001	B41691A5477Q003	B41791A5477Q001
1000	16 × 30	B41691A5108Q001	B41691A5108Q003	B41791A5108Q001
1000	18 × 25	B41691B5108Q001		B41791B5108Q001
1500	16 × 39	B41691A5158Q001	B41691A5158Q003	B41791A5158Q001
1500	18 × 30	B41691B5158Q001		B41791B5158Q001
1800	20 × 29	B41691A5188Q001		
2000	18 × 39	B41691A5208Q001		B41791A5208Q001
3000	21 × 39	B41691A5308Q001		B41791A5308Q001
4000	21 × 49	B41691A5408Q001		B41791A5408Q001
$V_R = 40 \text{ V DC}$				
330	12 × 30	B41691A7337Q001	B41691A7337Q003	B41791A7337Q001
470	14 × 30	B41691A7477Q001	B41691A7477Q003	B41791A7477Q001
680	16 × 30	B41691A7687Q001	B41691A7687Q003	B41791A7687Q001
680	18 × 25	B41691B7687Q001		B41791B7687Q001
820	16 × 35	B41691A7827Q001	B41691A7827Q003	B41791A7827Q001
1000	16 × 39	B41691A7108Q001	B41691A7108Q003	B41791A7108Q001
1000	18 × 30	B41691B7108Q001		B41791B7108Q001
1200	20 × 29	B41691A7128Q001		
1500	18 × 39	B41691A7158Q001		B41791A7158Q001
2200	21 × 39	B41691A7228Q001		B41791A7228Q001
2700	21 × 49	B41691A7278Q001		B41791A7278Q001
$V_R = 63 \text{ V DC}$				
220	12 × 30	B41691C8227Q001	B41691C8227Q003	B41791C8227Q001
240	14 × 25	B41691C8247Q001	B41691C8247Q003	B41791C8247Q001
330	14 × 30	B41691C8337Q001	B41691C8337Q003	B41791C8337Q001
360	16 × 25	B41691C8367Q001	B41691C8367Q003	B41791C8367Q001
430	18 × 25	B41691C8437Q001		B41791C8437Q001
470	16 × 30	B41691C8477Q001	B41691C8477Q003	B41791C8477Q001
560	16 × 35	B41691C8567Q001	B41691C8567Q003	B41791C8567Q001
620	18 × 30	B41691C8627Q001		B41791C8627Q001
680	16 × 39	B41691C8687Q001	B41691C8687Q003	B41791C8687Q001
750	18 × 35	B41691C8757Q001		B41791C8757Q001
820	21 × 30	B41691C8827Q001		B41791C8827Q001
910	18 × 39	B41691C8917Q001		B41791C8917Q001
1000	21 × 35	B41691C8108Q001		B41791C8108Q001
1300	21 × 39	B41691C8138Q001		B41791C8138Q001
1600	21 × 49	B41691C8168Q001		B41791C8168Q001

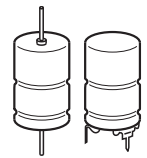

B41691, B41791
Low ESR – up to 150 °C
Technical data

C_R 100 Hz 20 °C μF	Case dimensions $d \times l$ mm	ESR_{max} 100 Hz 20 °C m Ω	ESR_{max} 100 Hz -40 °C m Ω	ESR_{max} 10 kHz 20 °C m Ω	Z_{max} 100 kHz 20 °C m Ω	$I_{\text{AC,max}}$ 10 kHz 105 °C A	$I_{\text{AC,max}}$ 10 kHz 125 °C A	$I_{\text{AC,R}}$ 10 kHz 125 °C A	$I_{\text{AC,max}}$ 10 kHz 150 °C A
$V_R = 25 \text{ V DC}$									
330	12 × 30	290	1600	150	150	4.3	3.4	2.1	1.05
470	14 × 25	210	1200	110	102	4.6	3.7	2.2	1.1
1000	16 × 30	110	550	60	55	6.5	5.2	3.2	1.6
1000	18 × 25	100	550	53	50	7.4	5.9	3.6	1.8
1500	16 × 39	73	370	42	39	9.0	7.2	4.4	2.2
1500	18 × 30	69	370	38	35	9.4	7.5	4.6	2.3
1800	20 × 29	58	300	32	30	10.1	8.1	4.9	2.4
2000	18 × 39	50	270	28	26	12.7	10.2	6.2	3.1
3000	21 × 39	37	180	22	21	14.3	11.5	7.0	3.5
4000	21 × 49	29	135	17	16	18.0	14.5	8.8	4.4
$V_R = 40 \text{ V DC}$									
330	12 × 30	240	1250	115	105	4.8	3.8	2.3	1.15
470	14 × 30	170	900	85	77	5.7	4.6	2.8	1.4
680	16 × 30	120	600	65	60	6.5	5.2	3.1	1.5
680	18 × 25	115	600	60	55	7.2	5.8	3.5	1.7
820	16 × 35	95	500	54	49	7.7	6.2	3.7	1.8
1000	16 × 39	80	410	45	41	8.9	7.2	4.3	2.1
1000	18 × 30	77	410	40	37	9.2	7.4	4.5	2.2
1200	20 × 29	55	320	35	33	10.0	8.0	4.9	2.4
1500	18 × 39	53	270	27	25	12.7	10.2	6.2	3.1
2200	21 × 39	39	185	21	20	14.3	11.5	7.0	3.5
2700	21 × 49	30	150	18	17	17.9	14.4	8.7	4.3
$V_R = 63 \text{ V DC}$									
220	12 × 30	279	925	90	86	5.2	4.0	2.5	1.3
240	14 × 25	263	853	90	85	4.8	3.7	2.3	1.2
330	14 × 30	193	621	67	63	6.0	4.7	2.9	1.5
360	16 × 25	189	576	72	68	5.1	4.0	2.5	1.3
430	18 × 25	146	475	49	47	7.5	5.8	3.7	1.8
470	16 × 30	144	442	55	52	6.5	5.0	3.1	1.6
560	16 × 35	120	370	45	43	7.7	6.0	3.8	1.9
620	18 × 30	103	331	35	33	9.5	7.4	4.6	2.3
680	16 × 39	99.9	306	38	36	8.8	6.8	4.3	2.1
750	18 × 35	84.4	273	29	28	11.2	8.8	5.5	2.7
820	21 × 30	80.6	252	30	28	10.3	8.1	5.1	2.5
910	18 × 39	70.1	226	24	23	12.7	10.0	6.2	3.1
1000	21 × 35	66.1	207	24	23	12.3	9.6	6.0	3.0
1300	21 × 39	52.2	160	20	19	13.9	10.8	6.8	3.4
1600	21 × 49	42.1	130	16	15	17.7	13.8	8.6	4.3

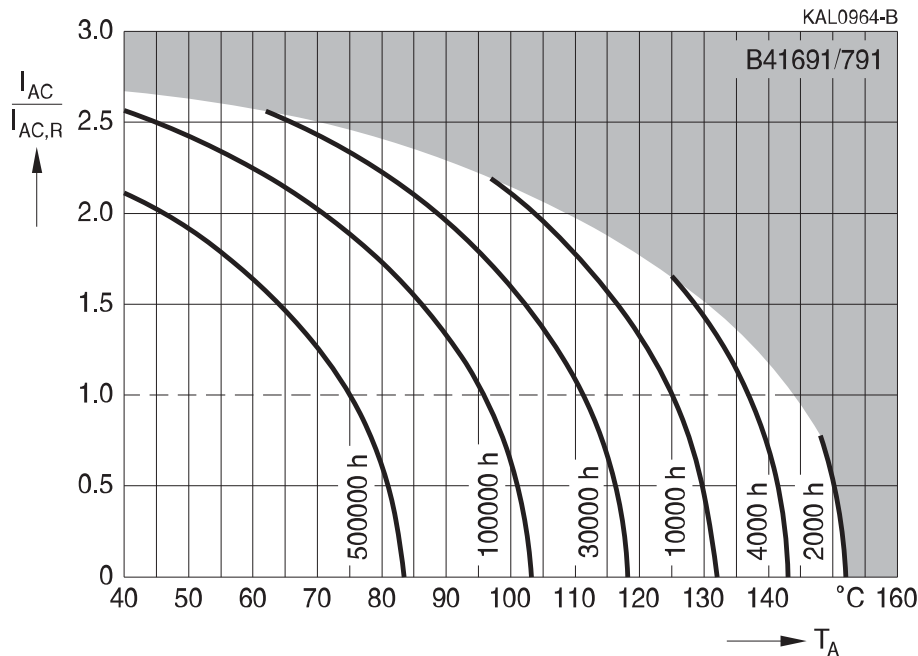

Useful life¹⁾

depending on ambient temperature T_A under ripple current operating conditions at V_R



Useful life¹⁾

depending on case temperature T_C under ripple current operating conditions at V_R

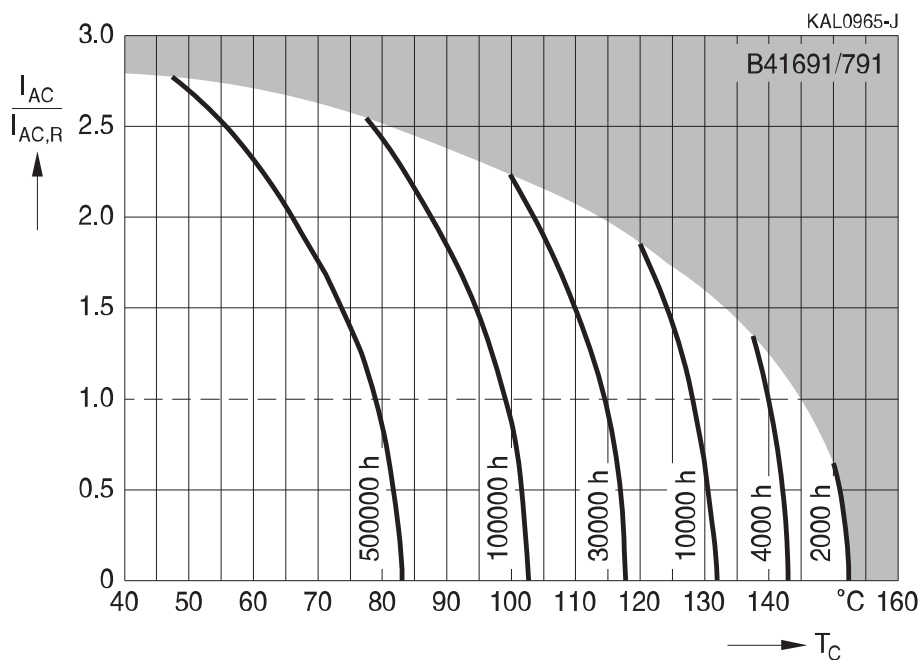

1) Refer to chapter "General technical information, 5 Useful life" on how to interpret useful life.

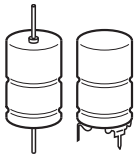

B41691, B41791

Low ESR – up to 150 °C

Frequency factor of permissible ripple current I_{AC} versus frequency f

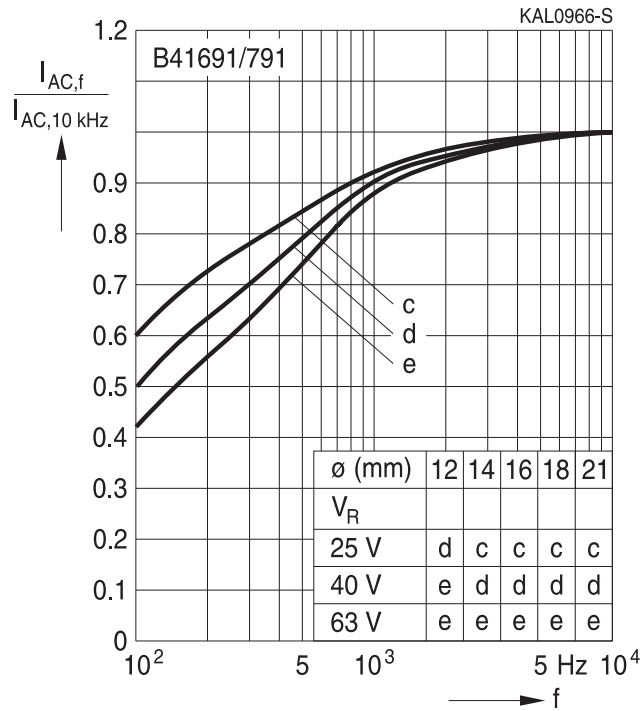

Frequency characteristics of ESR Typical behavior

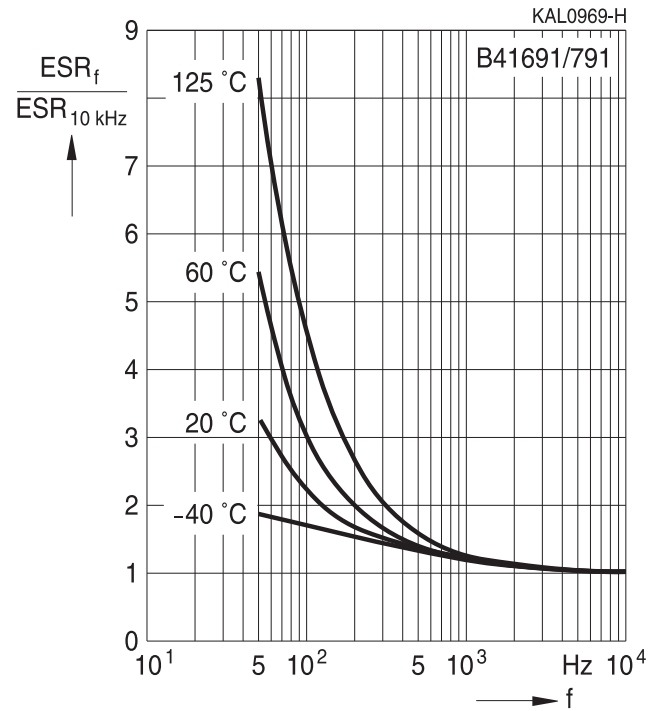

Equivalent series resistance ESR versus frequency f

Typical behavior for 910 μ F/63 V

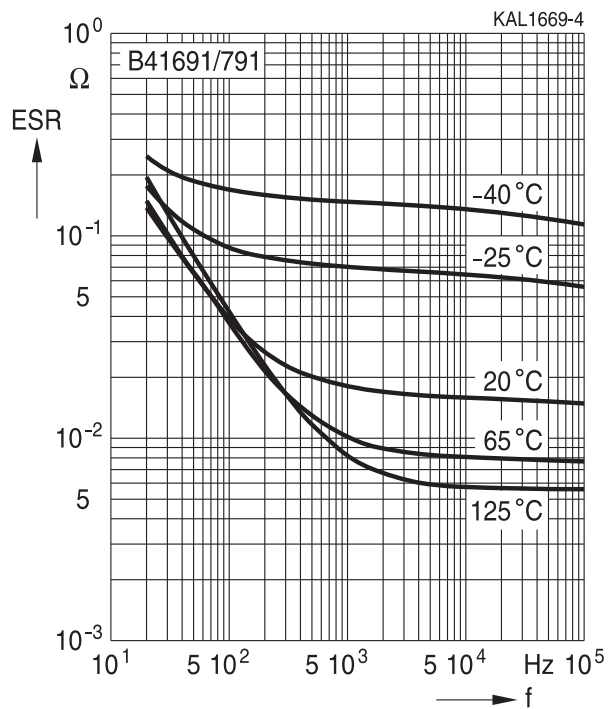

Impedance Z versus frequency f

Typical behavior for 910 μ F/63 V

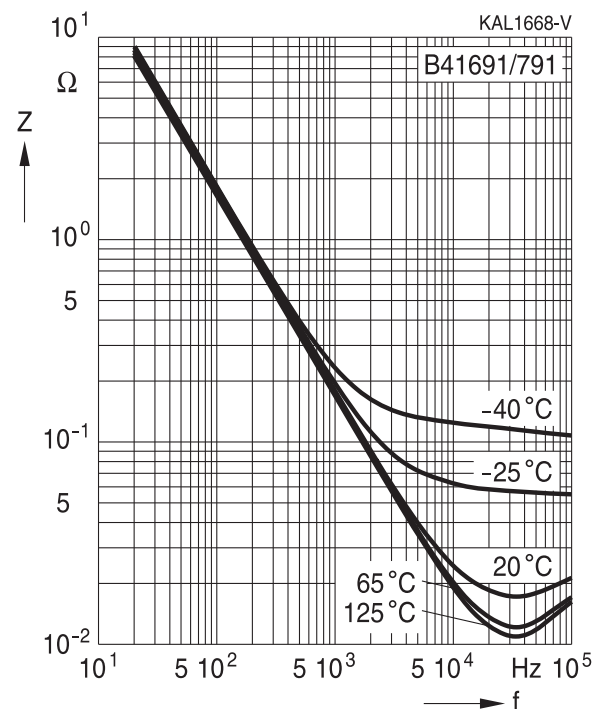

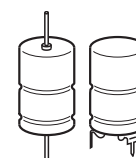

Cautions and warnings

Personal safety

The electrolytes used by EPCOS have been optimized both with a view to the intended application and with regard to health and environmental compatibility. They do not contain any solvents that are detrimental to health, e.g. dimethyl formamide (DMF) or dimethyl acetamide (DMAC).

Furthermore, some of the high-voltage electrolytes used by EPCOS are self-extinguishing.

As far as possible, EPCOS does not use any dangerous chemicals or compounds to produce operating electrolytes, although in exceptional cases, such materials must be used in order to achieve specific physical and electrical properties because no alternative materials are currently known. We do, however, restrict the amount of dangerous materials used in our products to an absolute minimum.

Materials and chemicals used in EPCOS aluminum electrolytic capacitors are continuously adapted in compliance with the EPCOS Corporate Environmental Policy and the latest EU regulations and guidelines such as RoHS, REACH/SVHC, GADSL, and ELV.

MDS (Material Data Sheets) are available on the EPCOS website for all types listed in the data book. MDS for customer specific capacitors are available upon request.

MSDS (Material Safety Data Sheets) are available for all of our electrolytes upon request.

Nevertheless, the following rules should be observed when handling aluminum electrolytic capacitors: No electrolyte should come into contact with eyes or skin. If electrolyte does come into contact with the skin, wash the affected areas immediately with running water. If the eyes are affected, rinse them for 10 minutes with plenty of water. If symptoms persist, seek medical treatment. Avoid inhaling electrolyte vapor or mists. Workplaces and other affected areas should be well ventilated. Clothing that has been contaminated by electrolyte must be changed and rinsed in water.



B41691, B41791

Low ESR – up to 150 °C

Product safety

The table below summarizes the safety instructions that must be observed without fail. A detailed description can be found in the relevant sections of chapter "General technical information".

Topic	Safety information	Reference chapter "General technical information"
Polarity	Make sure that polar capacitors are connected with the right polarity.	1 "Basic construction of aluminum electrolytic capacitors"
Reverse voltage	Voltages of opposite polarity should be prevented by connecting a diode.	3.1.6 "Reverse voltage"
Mounting position of screw-terminal capacitors	Screw terminal capacitors must not be mounted with terminals facing down unless otherwise specified.	11.1. "Mounting positions of capacitors with screw terminals"
Robustness of terminals	The following maximum tightening torques must not be exceeded when connecting screw terminals: M5: 2.5 Nm M6: 4.0 Nm	11.3 "Mounting torques"
Mounting of single-ended capacitors	The internal structure of single-ended capacitors might be damaged if excessive force is applied to the lead wires. Avoid any compressive, tensile or flexural stress. Do not move the capacitor after soldering to PC board. Do not pick up the PC board by the soldered capacitor. Do not insert the capacitor on the PC board with a hole space different to the lead space specified.	11.4 "Mounting considerations for single-ended capacitors"
Soldering	Do not exceed the specified time or temperature limits during soldering.	11.5 "Soldering"
Soldering, cleaning agents	Do not allow halogenated hydrocarbons to come into contact with aluminum electrolytic capacitors.	11.6 "Cleaning agents"
Upper category temperature	Do not exceed the upper category temperature.	7.2 "Maximum permissible operating temperature"
Passive flammability	Avoid external energy, e.g. fire.	8.1 "Passive flammability"



Topic	Safety information	Reference chapter "General technical information"
Active flammability	Avoid overload of the capacitors.	8.2 "Active flammability"
Maintenance	Make periodic inspections of the capacitors. Before the inspection, make sure that the power supply is turned off and carefully discharge the capacitors. Do not apply excessive mechanical stress to the capacitor terminals when mounting.	10 "Maintenance"
Storage	Do not store capacitors at high temperatures or high humidity. Capacitors should be stored at +5 to +35 °C and a relative humidity of ≤ 75%.	7.3 "Shelf life and storage conditions"
		Reference chapter "Capacitors with screw terminals"
Breakdown strength of insulating sleeves	Do not damage the insulating sleeve, especially when ring clips are used for mounting.	"Screw terminals – accessories"

Display of ordering codes for EPCOS products

The ordering code for one and the same product can be represented differently in data sheets, data books, other publications and the website of EPCOS, or in order-related documents such as shipping notes, order confirmations and product labels. The varying representations of the ordering codes are due to different processes employed and do not affect the specifications of the respective products.

Detailed information can be found on the Internet under www.epcos.com/orderingcodes.



B41691, B41791

Low ESR – up to 150 °C

Symbols and terms

Symbol	English	German
C	Capacitance	Kapazität
C_R	Rated capacitance	Nennkapazität
C_S	Series capacitance	Serienkapazität
$C_{S,T}$	Series capacitance at temperature T	Serienkapazität bei Temperatur T
C_f	Capacitance at frequency f	Kapazität bei Frequenz f
d	Case diameter, nominal dimension	Gehäusedurchmesser, Nennmaß
d_{max}	Maximum case diameter	Maximaler Gehäusedurchmesser
ESL	Self-inductance	Eigeninduktivität
ESR	Equivalent series resistance	Ersatzserienwiderstand
ESR_f	Equivalent series resistance at frequency f	Ersatzserienwiderstand bei Frequenz f
ESR_T	Equivalent series resistance at temperature T	Ersatzserienwiderstand bei Temperatur T
f	Frequency	Frequenz
I	Current	Strom
I_{AC}	Alternating current (ripple current)	Wechselstrom
$I_{AC,RMS}$	Root-mean-square value of alternating current	Wechselstrom, Effektivwert
$I_{AC,f}$	Ripple current at frequency f	Wechselstrom bei Frequenz f
$I_{AC,max}$	Maximum permissible ripple current	Maximal zulässiger Wechselstrom
$I_{AC,R}$	Rated ripple current	Nennwechselstrom
I_{leak}	Leakage current	Reststrom
$I_{leak,op}$	Operating leakage current	Betriebsreststrom
l	Case length, nominal dimension	Gehäuselänge, Nennmaß
l_{max}	Maximum case length (without terminals and mounting stud)	Maximale Gehäuselänge (ohne Anschlüsse und Gewindebolzen)
R	Resistance	Widerstand
R_{ins}	Insulation resistance	Isolationswiderstand
R_{symm}	Balancing resistance	Symmetrierwiderstand
T	Temperature	Temperatur
ΔT	Temperature difference	Temperaturdifferenz
T_A	Ambient temperature	Umgebungstemperatur
T_C	Case temperature	Gehäusetemperatur
T_B	Capacitor base temperature	Temperatur des Gehäusebodens
t	Time	Zeit
Δt	Period	Zeitraum
t_b	Service life (operating hours)	Brauchbarkeitsdauer (Betriebszeit)

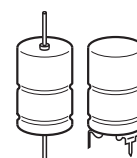

Symbol	English	German
V	Voltage	Spannung
V _F	Forming voltage	Formierspannung
V _{op}	Operating voltage	Betriebsspannung
V _R	Rated voltage, DC voltage	Nennspannung, Gleichspannung
V _S	Surge voltage	Spitzenspannung
X _C	Capacitive reactance	Kapazitiver Blindwiderstand
X _L	Inductive reactance	Induktiver Blindwiderstand
Z	Impedance	Scheinwiderstand
Z _T	Impedance at temperature T	Scheinwiderstand bei Temperatur T
tan δ	Dissipation factor	Verlustfaktor
λ	Failure rate	Ausfallrate
ε ₀	Absolute permittivity	Elektrische Feldkonstante
ε _r	Relative permittivity	Dielektrizitätszahl
ω	Angular velocity; 2 · π · f	Kreisfrequenz; 2 · π · f

Note

All dimensions are given in mm.

Important notes

The following applies to all products named in this publication:

1. Some parts of this publication contain **statements about the suitability of our products for certain areas of application**. These statements are based on our knowledge of typical requirements that are often placed on our products in the areas of application concerned. We nevertheless expressly point out **that such statements cannot be regarded as binding statements about the suitability of our products for a particular customer application**. As a rule we are either unfamiliar with individual customer applications or less familiar with them than the customers themselves. For these reasons, it is always ultimately incumbent on the customer to check and decide whether a product with the properties described in the product specification is suitable for use in a particular customer application.
2. We also point out that **in individual cases, a malfunction of electronic components or failure before the end of their usual service life cannot be completely ruled out in the current state of the art, even if they are operated as specified**. In customer applications requiring a very high level of operational safety and especially in customer applications in which the malfunction or failure of an electronic component could endanger human life or health (e.g. in accident prevention or life-saving systems), it must therefore be ensured by means of suitable design of the customer application or other action taken by the customer (e.g. installation of protective circuitry or redundancy) that no injury or damage is sustained by third parties in the event of malfunction or failure of an electronic component.
3. **The warnings, cautions and product-specific notes must be observed.**
4. In order to satisfy certain technical requirements, **some of the products described in this publication may contain substances subject to restrictions in certain jurisdictions (e.g. because they are classed as hazardous)**. Useful information on this will be found in our Material Data Sheets on the Internet (www.tdk-electronics.tdk.com/material). Should you have any more detailed questions, please contact our sales offices.
5. We constantly strive to improve our products. Consequently, **the products described in this publication may change from time to time**. The same is true of the corresponding product specifications. Please check therefore to what extent product descriptions and specifications contained in this publication are still applicable before or when you place an order.

We also **reserve the right to discontinue production and delivery of products**. Consequently, we cannot guarantee that all products named in this publication will always be available. The aforementioned does not apply in the case of individual agreements deviating from the foregoing for customer-specific products.

6. Unless otherwise agreed in individual contracts, **all orders are subject to our General Terms and Conditions of Supply**.
7. **Our manufacturing sites serving the automotive business apply the IATF 16949 standard**. The IATF certifications confirm our compliance with requirements regarding the quality management system in the automotive industry. Referring to customer requirements and customer specific requirements ("CSR") TDK always has and will continue to have the policy of respecting individual agreements. Even if IATF 16949 may appear to support the acceptance of unilateral requirements, we hereby like to emphasize that **only requirements mutually agreed upon can and will be implemented in our Quality Management System**. For clarification purposes we like to point out that obligations from IATF 16949 shall only become legally binding if individually agreed upon.

Important notes

8. The trade names EPCOS, CeraCharge, CeraDiode, CeraLink, CeraPad, CeraPlas, CSMP, CTVS, DeltaCap, DigiSiMic, ExoCore, FilterCap, FormFit, LeaXield, MiniBlue, MiniCell, MKD, MKK, MotorCap, PCC, PhaseCap, PhaseCube, PhaseMod, PhiCap, PowerHap, PQSine, PQvar, SIFERRIT, SIFI, SIKOREL, SilverCap, SIMDAD, SiMic, SIMID, SineFormer, SIOV, ThermoFuse, WindCap are **trademarks registered or pending** in Europe and in other countries. Further information will be found on the Internet at www.tdk-electronics.tdk.com/trademarks.

Release 2018-10