

High Performance RFI Line Filters

AMI-M11O Series

Metal Enclosure Single Phase Single Stage

AMI Designation	Input/output Style		Current Rating	Inductance	Capacitance		Resistor	Leakage Current @ 120 VAC 60Hz/250 VAC 50Hz	TIL Insertion Loss	Case Style
				mH	Cx	Cy	KΩ			
Available Part Numbers	6.3mm Spade Terminals	Threaded Bolts			nF	pF		mA		
AMI-M11O-1-6-B	1	-	6	1.0	1000	2800	330	0.22/0.36	001	A
AMI-M11OP-1-10-B	1	-	10	1.1	1000	2800	330	0.22/0.36	002	B
AMI-M11O-6-10-B	-	6	10	1.1	1000	2800	330	0.22/0.36	003	C
AMI-M11O-1-20-B	1	-	20	0.9	1000	2800	330	0.22/0.36	004	B
AMI-M11O-6-20-B	-	6	20	0.9	1000	2800	330	0.22/0.36	005	C
AMI-M11O-6-30-B	-	6	30	0.9	1000	2800	330	0.22/0.36	006	C
AMI-M11O-1-6-C	1	-	6	1.0	1000	10000	330	0.75/1.25	007	A
AMI-M11O-1-10-C	1	-	10	1.1	1000	10000	330	0.75/1.25	008	B
AMI-M11O-6-10-C	-	6	10	1.1	1000	10000	330	0.75/1.25	009	C
AMI-M11O-1-20-C	1	-	20	0.9	1000	10000	330	0.75/1.25	010	B
AMI-M11O-6-20-C	-	6	20	0.9	1000	10000	330	0.75/1.25	011	C
AMI-M11O-6-30-C	-	6	30	0.9	1000	10000	330	0.75/1.25	012	C

Electrical Schematic

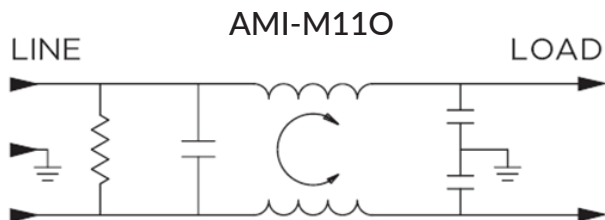

High Performance RFI Line Filters

Specifications:

- Rated Voltage (max): 250 VAC
- Operating Frequency: 50/60 Hz
- Operating Current: 6 to 30 A
- Hi-pot Rating (one minute): Line to Ground: 2250 VDC
Line to Line: 1450 VDC
- Operating Ambient Temperature Range (at rated current I_r): -10°C to $+40^{\circ}\text{C}$. In an ambient temperature (T_a) higher than $+40^{\circ}\text{C}$ the maximum operating current (I_o) is calculated as follows: $I_o = I_r \sqrt{[(85 - T_a)/45]}$

Performance Data Typical Insertion Loss

Measured in closed 50 Ohm system

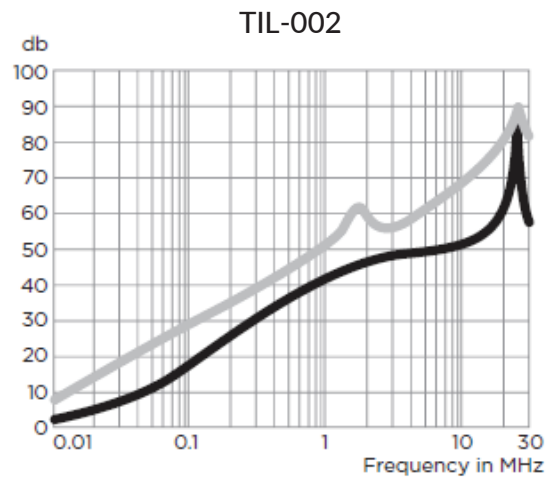
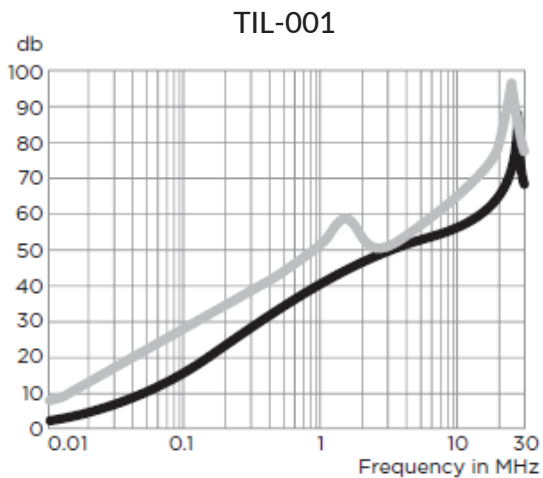

High Performance RFI Line Filters

Performance Data Typical Insertion Loss

Measured in closed 50 Ohm system

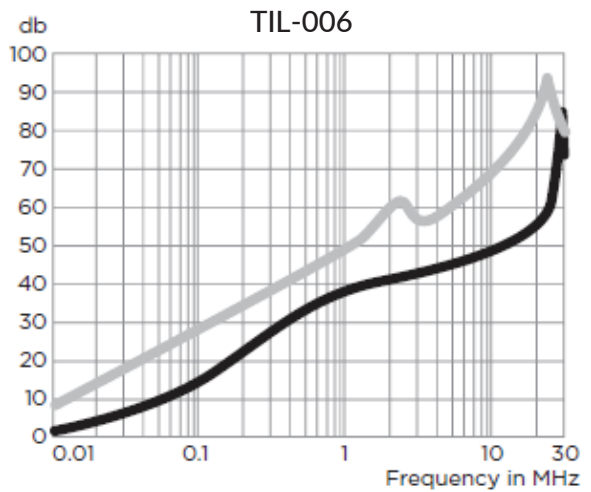
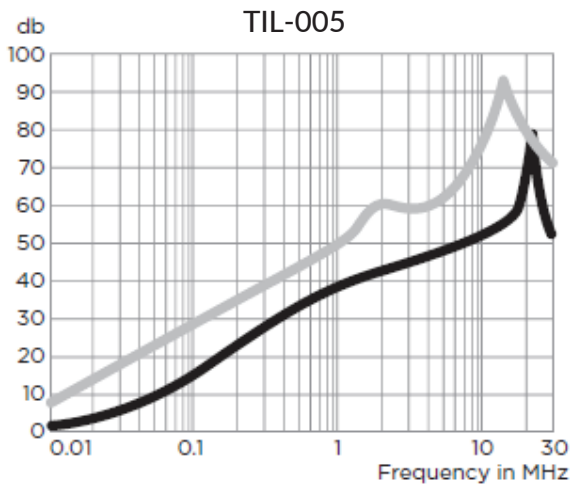
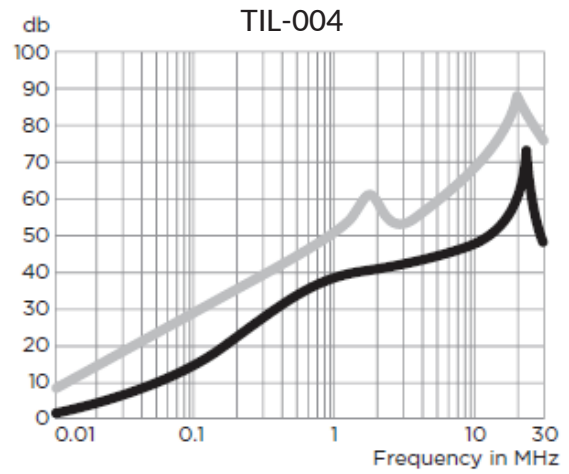
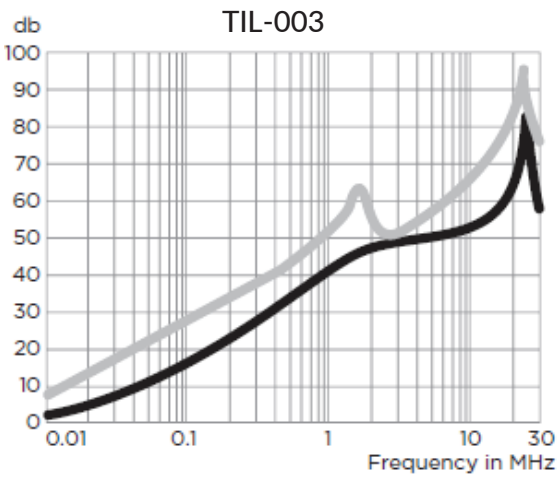

High Performance RFI Line Filters

Performance Data Typical Insertion Loss

Measured in closed 50 Ohm system

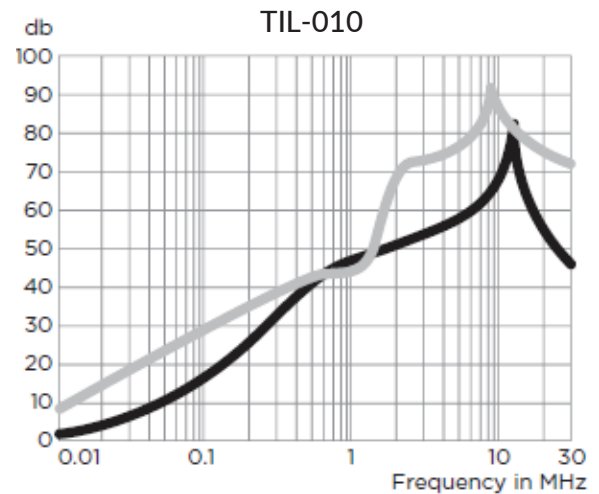
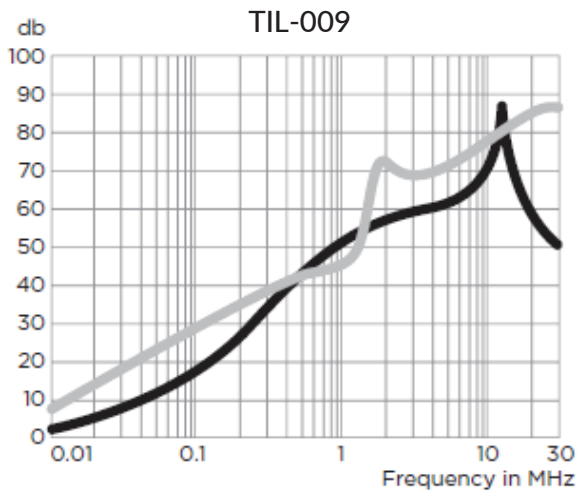
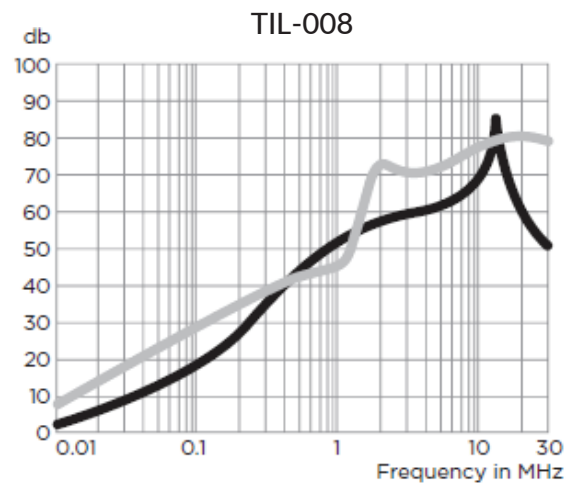
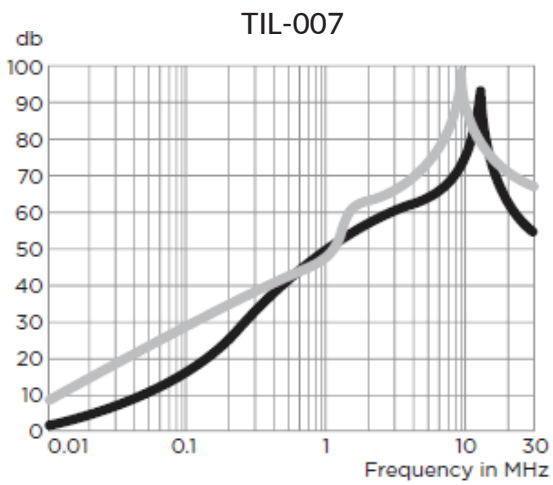

High Performance RFI Line Filters

Performance Data Typical Insertion Loss

Measured in closed 50 Ohm system

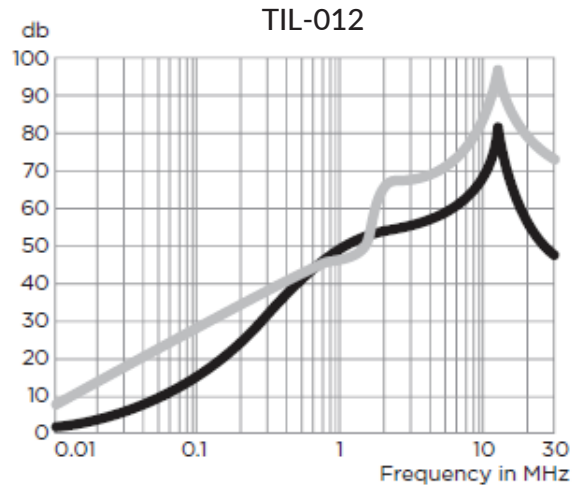
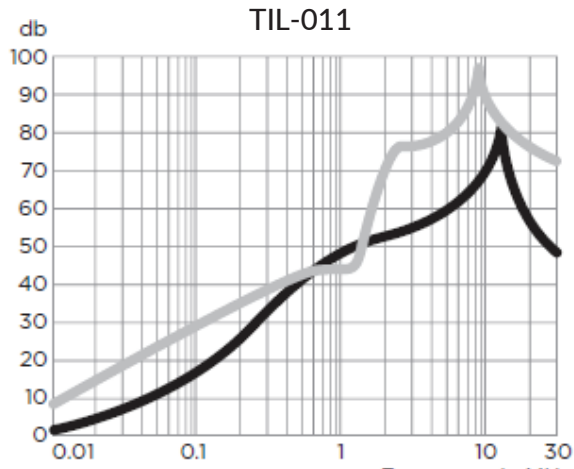

- Common Mode / Asymmetrical (L-G)
- Differential Mode / Symmetrical (L-L)

High Performance RFI Line Filters

Minimum Insertion Loss

Common Mode/Asymmetrical (Line to Ground)

Model Number	Frequency-MHz										
	.01	.05	.1	.15	.5	1	2	5	10	20	30
AMI-M110-1-6-B	3	8	13	17	31	37	40	47	50	58	62
AMI-M110-1-10-B	3	9	15	19	31	39	41	44	47	54	51
AMI-M110-6-10-B	3	9	14	18	31	39	41	44	47	54	54
AMI-M110-1-20-B	3	7	13	15	30	35	37	39	40	46	40
AMI-M110-6-20-B	3	7	13	16	30	35	39	40	44	58	46
AMI-M110-6-30-B	3	7	13	17	30	34	37	40	42	49	58
AMI-M110-1-6-C/D	3	8	14	19	37	47	51	58	66	59	49
AMI-M110-1-10-C/D	3	9	15	21	41	49	50	56	64	54	46
AMI-M110-6-10-C/D	3	9	15	21	39	49	50	56	64	54	44
AMI-M110-1-20-C/D	3	7	14	19	37	45	47	50	60	48	40
AMI-M110-6-20-C/D	3	7	14	19	37	44	49	52	62	48	41
AMI-M-110-6-30-C/D	3	6	13	18	37	45	49	51	60	50	42

High Performance RFI Line Filters

Minimum Insertion Loss

Differential Mode/Symmetrical (Line to Line)

Model Number	Frequency-MHz											
	.01	.03	.05	.1	.15	.5	1	2	5	10	20	30
AMI-M110-1-6-B	5	14	20	25	29	41	49	47	50	60	74	72
AMI-M110-1-10-B	5	15	20	26	29	41	47	50	54	64	74	74
AMI-M110-6-10-B	5	14	20	25	29	41	47	48	50	60	62	64
AMI-M110-1-20-B	5	15	21	26	29	41	45	48	54	63	70	66
AMI-M110-6-20-B	5	15	21	26	29	41	44	48	54	63	70	66
AMI-M110-6-30-B	5	15	20	25	29	40	46	50	50	58	70	70
AMI-M110-1-6-C/D	5	14	20	25	29	40	41	57	66	78	56	62
AMI-M110-1-10-C/D	5	15	21	26	29	39	40	60	64	67	67	64
AMI-M110-6-10-C/D	5	14	20	25	29	39	40	60	64	68	70	64
AMI-M110-1-20-C/D	5	15	20	26	29	40	42	60	68	70	70	67
AMI-M110-6-20-C/D	5	15	21	26	29	39	38	58	68	70	70	66
AMI-M-110-6-30-C/D	5	15	20	25	29	39	39	56	62	70	70	66

Case Styles

STYLE A

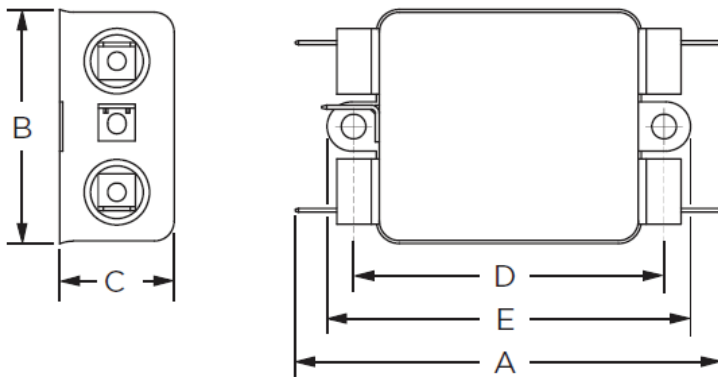

Typical Dimensions:

Line/Load Terminals (4): .250 [6.3] with .07 [1.8] Dia. hole
 Ground Terminal (1): .250 [6.3] with .07 x .16 [1.8 x 3.8] slot
 Mounting Holes (2): .188 [4.75] Dia.

High Performance RFI Line Filters

Case Styles

STYLE B

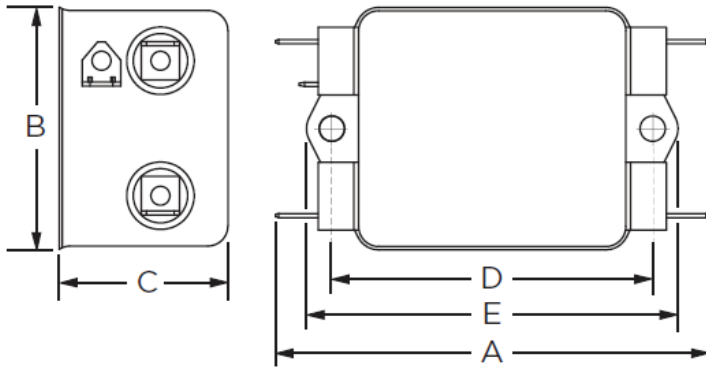

Typical Dimensions:

Line/Load Terminals (4):	.250 [6.3] with .07 [1.8] Dia. hole
Ground Terminal (1):	.250 [6.3] with .07 x .16 [1.8 x 3.8] slot
Mounting Holes (2):	.188 [4.75] Dia.

STYLE C

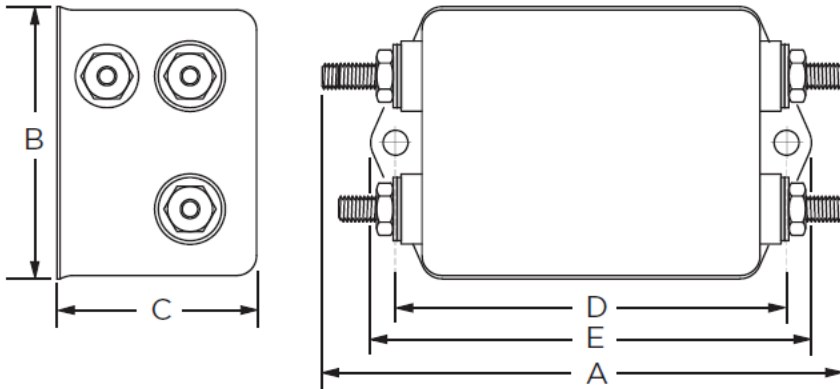

Typical Dimensions:

Terminals (5):	8-32, Torque 18 lbf-in. [2.03 N-m] max. ± 2 [.22]
Mounting Holes (2):	.188 [4.75] Dia.

High Performance RFI Line Filters

Case Dimensions:

Model Number	A max	B max	C max	D $\begin{smallmatrix} \pm .015 \\ \pm .38 \end{smallmatrix}$	E max
AMI-M110-1-6	3.36"/85.34m	1.82"/46.23mm	0.91"/23.11mm	2.375"/60.325mm	2.78"/70.61mm
AMI-M110-1-10	3.36"/85.34m	1.82"/46.23mm	1.28"/32.51mm	2.375"/60.325mm	2.78"/70.61mm
AMI-M110-6-10	3.47"/88.14mm	1.82"/46.23mm	1.53"/38.86mm	2.375"/60.325mm	2.78"/70.61mm
AMI-M110-1-20	3.85"/97.79mm	2.07"/52.58mm	1.31"/33.27mm	2.938"/74.625mm	3.35"/85.09mm
AMI-M110-6-20	4.00"/101.60mm	2.07"/52.58mm	1.53"/38.86mm	2.938"/74.625mm	3.35"/85.09mm
AMI-M110-6-30	4.92"/124.97mm	2.07"/52.58mm	1.53"/38.86mm	3.947"/100.254mm	4.33"/109.98mm