

Power Inductor APSD Series

**Automotive
AEC-Q200**

RoHS Compliant
Halogen Free
REACH Compliant



Power Circuit
Unshield
Wire Wound
Ferrite

Part Numbering

A	PSD	00	030321	1R0	M	00
Grade	Series Name	Control Code	Dimensions Code (mm)	Inductance (uH)	Tolerance	Internal Code
			030321 3.3x3.0x2.1	R47 0.47	K ±10%	
			050432 4.5x4.0x3.2	1R0 1.0	M ±20%	
			060530 5.8x5.2x3.0	101 100	T ±30%	
			060545 5.8x5.2x4.5			
			080735 7.8x7.0x3.5			
			080750 7.8x7.0x5.0			

Please be sure to request approval specifications that provide further details of the products. Kindly note that the content of these specifications are subject to change or may be discontinued without prior notice. This product may not be designed/used in medical or high risk applications without Chilisin approval. Please contact our sales department before ordering.

Power Inductor APSD Series

Automotive
AEC-Q200

APSD00030321 Type

■ Dimensions

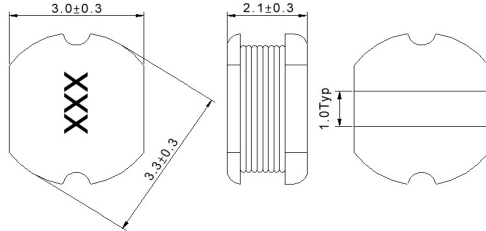

■ Recommended Land Pattern

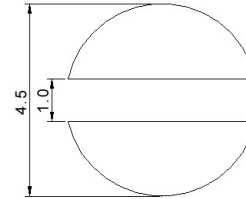

■ Electrical Characteristics

unit:mm

unit:mm

Part No.	Inductance (uH)	Test Freq.	RDC (Ω)Max.	Isat (A)	Irms (A)	Tolerance (±%)	Marking
APSD00030321R82□00	0.82	7.96 MHz,1 V	0.06	2.2	2.53	30	AX
APSD00030321R0□00	1	7.96 MHz,1 V	0.07	2.08	2.39	20	BA
APSD00030321R4□00	1.4	7.96 MHz,1 V	0.09	1.86	2.14	20	BE
APSD00030321R5□00	1.5	7.96 MHz,1 V	0.11	1.8	2.07	20	BF
APSD00030321R8□00	1.8	7.96 MHz,1 V	0.11	1.8	2.07	20	BI
APSD00030321R2□00	2.2	7.96 MHz,1 V	0.13	1.39	1.60	20	CC
APSD00030321R7□00	2.7	7.96 MHz,1 V	0.14	1.32	1.52	20	CH
APSD00030321R3□00	3.3	7.96 MHz,1 V	0.17	1.25	1.44	20	DD
APSD00030321R9□00	3.9	7.96 MHz,1 V	0.19	1.2	1.38	20	DJ
APSD00030321R7□00	4.7	7.96 MHz,1 V	0.21	1.13	1.30	20	EH
APSD00030321R6□00	5.6	7.96 MHz,1 V	0.22	0.91	1.05	20	FG
APSD00030321R8□00	6.8	7.96 MHz,1 V	0.25	0.85	0.98	20	GI
APSD00030321R0□00	7	7.96 MHz,1 V	0.28	0.82	0.94	20	HA
APSD00030321R2□00	8.2	7.96 MHz,1 V	0.28	0.82	0.94	20	IC
APSD00030321100□00	10	2.52 MHz,1 V	0.32	0.74	0.85	10,20	KA
APSD00030321120□00	12	2.52 MHz,1 V	0.35	0.64	0.74	20	QA
APSD00030321150□00	15	2.52 MHz,1 V	0.4	0.6	0.69	20	MA
APSD00030321180□00	18	2.52 MHz,1 V	0.48	0.54	0.62	20	RA
APSD00030321220□00	22	2.52 MHz,1 V	0.58	0.5	0.58	10,20	LA
APSD00030321270□00	27	2.52 MHz,1 V	0.65	0.43	0.49	20	SA
APSD00030321330□00	33	2.52 MHz,1 V	0.8	0.4	0.46	20	NA
APSD00030321390□00	39	2.52 MHz,1 V	0.9	0.37	0.43	20	PA
APSD00030321470□00	47	2.52 MHz,1 V	1.19	0.36	0.41	20	OA
APSD00030321500□00	50	2.52 MHz,1 V	1.22	0.33	0.38	20	TA
APSD00030321560□00	56	2.52 MHz,1 V	1.27	0.31	0.36	20	UA
APSD00030321680□00	68	2.52 MHz,1 V	1.73	0.3	0.35	10,20	VA
APSD00030321750□00	75	2.52 MHz,1 V	1.9	0.29	0.33	20	WA
APSD00030321820□00	82	2.52 MHz,1 V	1.99	0.28	0.32	10,20	XA
APSD00030321101□00	100	1 kHz,1 V	2.52	0.25	0.29	10,20	KB
APSD00030321121□00	120	1 kHz,1 V	2.9	0.2	0.23	10,20	QB
APSD00030321151□00	150	1 kHz,1 V	3.36	0.19	0.22	20	MB
APSD00030321181□00	180	1 kHz,1 V	5.1	0.17	0.20	20	RB
APSD00030321221□00	220	1 kHz,1 V	5.8	0.16	0.18	10,20	LB
APSD00030321271□00	270	1 kHz,1 V	7.8	0.14	0.16	10,20	SB

Note: When ordering, please specify tolerance code. Tolerance: K=±10% / M=±20% / T=±30%

1. Operating temperature range -40°C ~ 125°C (Including self - temperature rise)
2. Isat for Inductance drop 10% from its value without current
3. I rms for a 40°C temperature rise from 25°C ambient.
4. Measure Equipment:
 - L: Agilent E4980 or HP4284A (over 1MHz), HP4285A (under 1MHz)
 - RDC: Chroma 16502
 - Isat: HP4284+42841A or WK3260B+WK3265B
 - I rms: WK3255BQ+ WK3265B (or equivalent)

Please be sure to request approval specifications that provide further details of the products. Kindly note that the content of these specifications are subject to change or may be discontinued without prior notice. This product may not be designed/used in medical or high risk applications without Chilisin approval. Please contact our sales department before ordering.

APSD00030321 Type

Characteristics Graph

Inductance vs. Frequency Charateristics

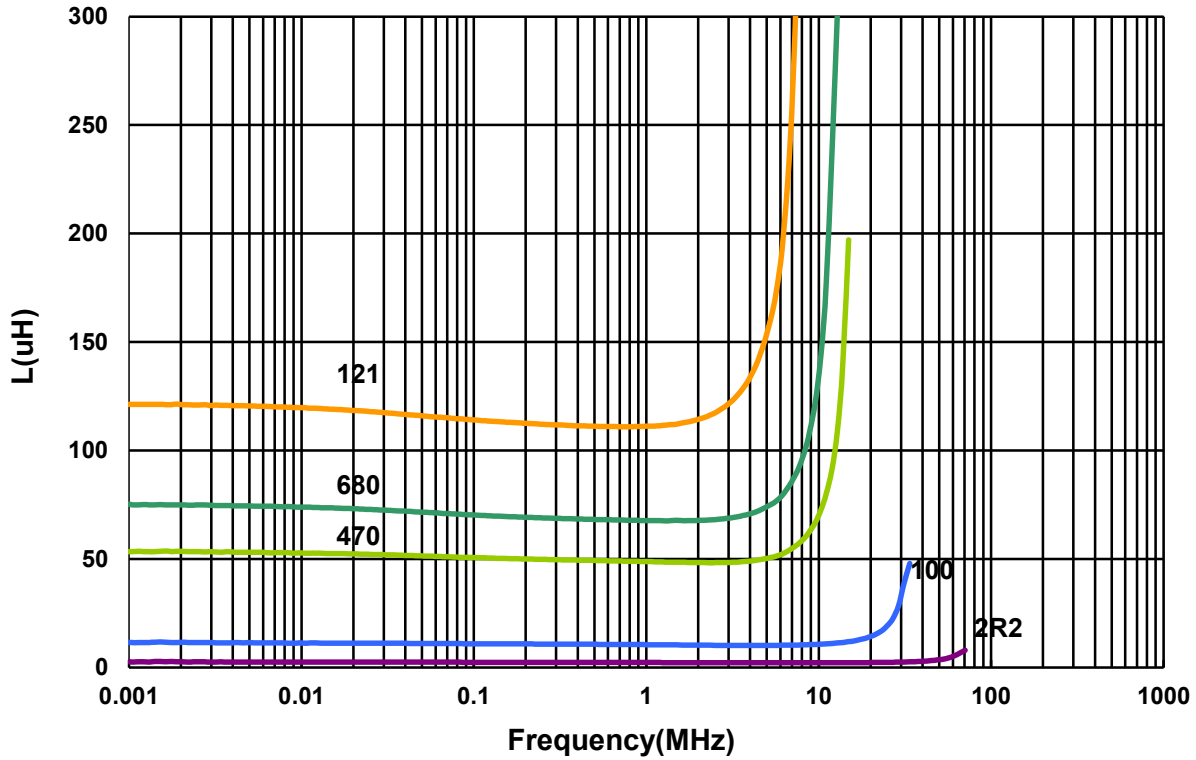

Inductance vs. DC Current

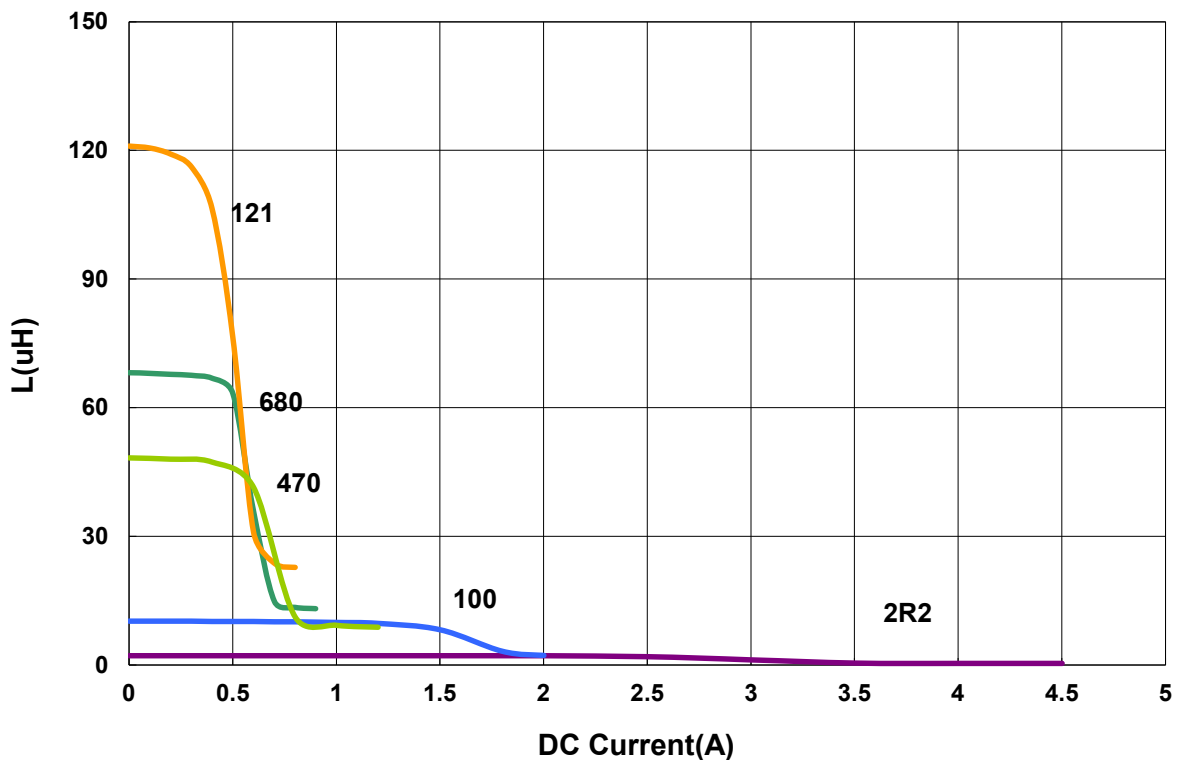

Please be sure to request approval specifications that provide further details of the products. Kindly note that the content of these specifications are subject to change or may be discontinued without prior notice. This product may not be designed/used in medical or high risk applications without Chilisin approval. Please contact our sales department before ordering.

APSD00050432 Type

■ Dimensions

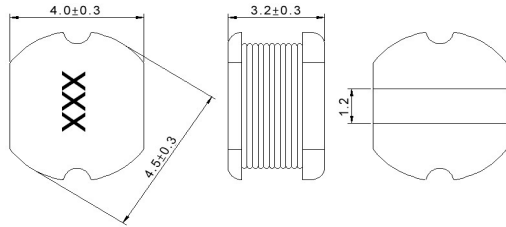

unit:mm

■ Recommended Land Pattern

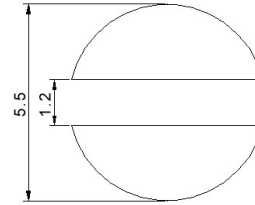

unit:mm

■ Electrical Characteristics

Part No.	Inductance (uH)	Test Freq.	RDC (Ω)Max.	Isat (A)	Tolerance (±%)	Marking
APSD00050432R15□00	0.15	7.96 MHz,1 V	0.0085	7.5	30	R15
APSD000504321R0□00	1	7.96 MHz,1 V	0.033	3.8	10,20	1R0
APSD000504321R2□00	1.2	7.96 MHz,1 V	0.035	3.5	20	1R2
APSD000504321R4□00	1.4	7.96 MHz,1 V	0.038	3.3	20	1R4
APSD000504321R8□00	1.8	7.96 MHz,1 V	0.042	2.91	10,20	1R8
APSD000504322R2□00	2.2	7.96 MHz,1 V	0.047	2.6	10,20	2R2
APSD000504322R7□00	2.7	7.96 MHz,1 V	0.052	2.43	20	2R7
APSD000504323R3□00	3.3	7.96 MHz,1 V	0.058	2.15	10,20	3R3
APSD000504323R9□00	3.9	7.96 MHz,1 V	0.076	1.98	20	3R9
APSD000504324R7□00	4.7	7.96 MHz,1 V	0.094	1.7	10,20	4R7
APSD000504325R6□00	5.6	7.96 MHz,1 V	0.101	1.6	10,20	5R6
APSD000504326R2□00	6.2	7.96 MHz,1 V	0.11	1.5	20	6R2
APSD000504326R8□00	6.8	7.96 MHz,1 V	0.117	1.41	10,20	6R8
APSD000504328R2□00	8.2	7.96 MHz,1 V	0.132	1.26	10,20	8R2
APSD00050432100□00	10	2.52 MHz,1 V	0.182	1.15	10,20	100
APSD00050432120□00	12	2.52 MHz,1 V	0.21	1.05	20	120
APSD00050432150□00	15	2.52 MHz,1 V	0.235	0.92	10,20	150
APSD00050432180□00	18	2.52 MHz,1 V	0.338	0.84	20	180
APSD00050432220□00	22	2.52 MHz,1 V	0.378	0.76	10,20	220
APSD00050432270□00	27	2.52 MHz,1 V	0.522	0.71	20	270
APSD00050432330□00	33	2.52 MHz,1 V	0.54	0.64	10,20	330
APSD00050432390□00	39	2.52 MHz,1 V	0.587	0.59	10,20	390
APSD00050432470□00	47	2.52 MHz,1 V	0.844	0.54	10,20	470
APSD00050432560□00	56	2.52 MHz,1 V	0.937	0.5	10,20	560
APSD00050432680□00	68	2.52 MHz,1 V	1.117	0.46	10,20	680
APSD00050432101□00	100	1 kHz,1 V	2	0.4	10,20	101
APSD00050432121□00	120	1 kHz,1 V	1.8	0.38	10,20	121
APSD00050432151□00	150	1 kHz,1 V	2.8	0.3	10,20	151
APSD00050432181□00	180	1 kHz,1 V	3.2	0.25	10,20	181
APSD00050432221□00	220	1 kHz,1 V	4	0.15	10,20	221
APSD00050432331□00	330	1 kHz,1 V	5.85	0.21	10,20	331

Note: When ordering, please specify tolerance code. Tolerance: K=±10% / M=±20% / T=±30%

1. Operating temperature range -40°C~125°C(Including self - temperature rise)

2. Isat for Inductance drop 10% from its value without current

3. Measure Equipment:

L: Agilent E4980 or HP4284A (over 1MHz), HP4285A (under 1MHz)

RDC: Chroma 16502

Isat: HP4284+42841A or WK3260B+WK3265B

APSD00050432 Type

Characteristics Graph

Inductance vs. Frequency Characteristics

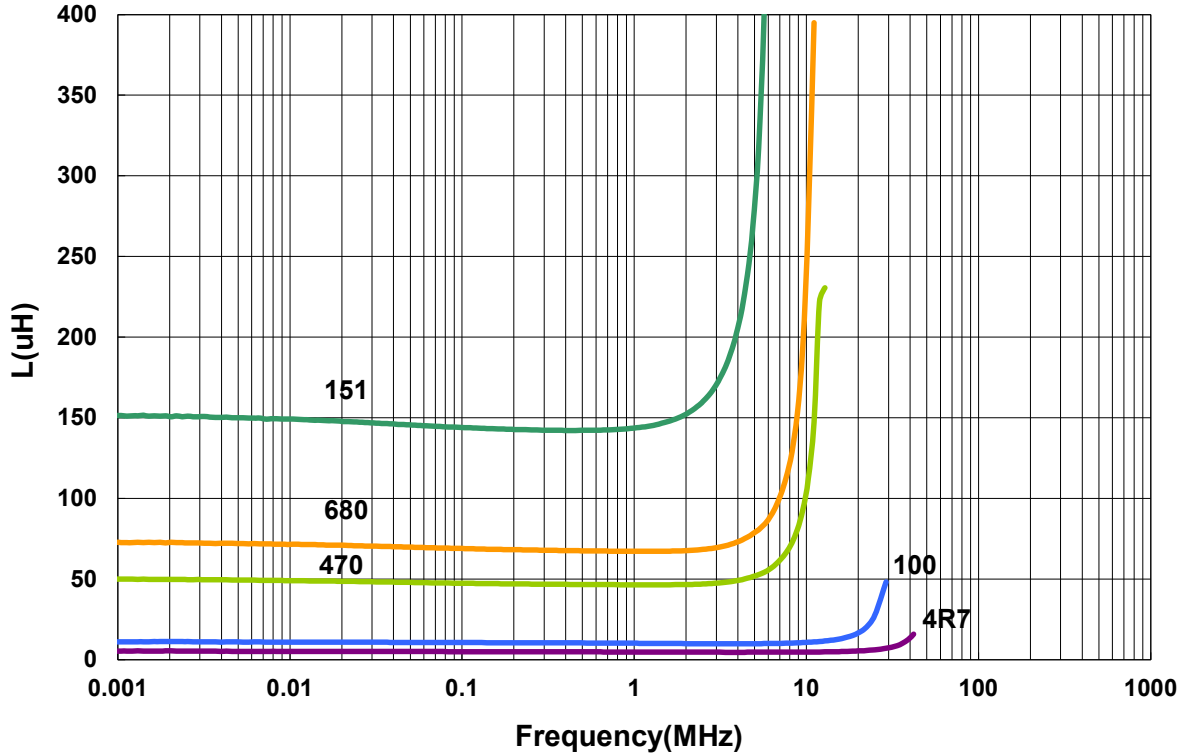

Inductance vs. DC Current

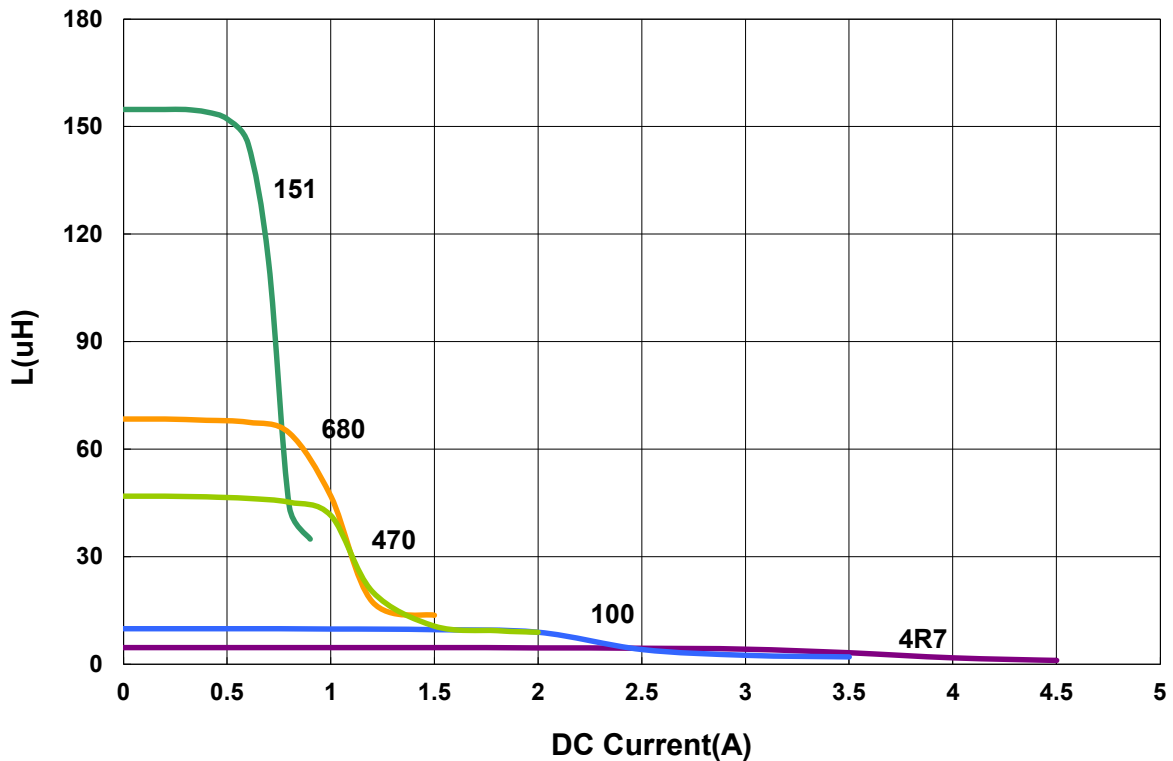

Please be sure to request approval specifications that provide further details of the products. Kindly note that the content of these specifications are subject to change or may be discontinued without prior notice. This product may not be designed/used in medical or high risk applications without Chilisin approval. Please contact our sales department before ordering.

APSD00060530 Type

■ Dimensions

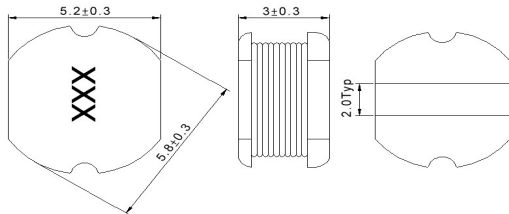

unit:mm

■ Recommended Land Pattern

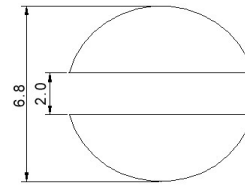

unit:mm

■ Electrical Characteristics

Part No.	Inductance (uH)	Test Freq.	RDC (Ω)Max.	Isat (A)	Tolerance (±%)	Marking
APSD000605301R0□00	1	7.96 MHz,1 V	0.03	4.5	20	1R0
APSD000605301R2□00	1.2	7.96 MHz,1 V	0.03	4.2	20	1R2
APSD000605301R5□00	1.5	7.96 MHz,1 V	0.03	4.1	20	1R5
APSD000605301R8□00	1.8	7.96 MHz,1 V	0.03	3.7	10,20	1R8
APSD000605302R0□00	2	7.96 MHz,1 V	0.03	3.6	20	2R0
APSD000605302R2□00	2.2	7.96 MHz,1 V	0.03	3.5	20	2R2
APSD000605302R7□00	2.7	7.96 MHz,1 V	0.04	3.2	20	2R7
APSD000605303R3□00	3.3	7.96 MHz,1 V	0.05	2.8	10,20	3R3
APSD000605303R9□00	3.9	7.96 MHz,1 V	0.06	2.6	20	3R9
APSD000605304R7□00	4.7	7.96 MHz,1 V	0.07	2.5	10,20	4R7
APSD000605305R6□00	5.6	7.96 MHz,1 V	0.08	2.4	20	5R6
APSD000605306R8□00	6.8	7.96 MHz,1 V	0.09	2.2	20	6R8
APSD000605308R2□00	8.2	7.96 MHz,1 V	0.1	2	20	8R2
APSD00060530100□00	10	2.52 MHz,1 V	0.12	1.8	10,20	100
APSD00060530120□00	12	2.52 MHz,1 V	0.13	1.75	20	120
APSD00060530150□00	15	2.52 MHz,1 V	0.15	1.7	10,20	150
APSD00060530180□00	18	2.52 MHz,1 V	0.22	1.6	10,20	180
APSD00060530220□00	22	2.52 MHz,1 V	0.22	1.5	10,20	220
APSD00060530270□00	27	2.52 MHz,1 V	0.26	1.4	20	270
APSD00060530330□00	33	2.52 MHz,1 V	0.33	1.1	10,20	330
APSD00060530390□00	39	2.52 MHz,1 V	0.42	1	10,20	390
APSD00060530470□00	47	2.52 MHz,1 V	0.5	0.9	10,20	470
APSD00060530560□00	56	2.52 MHz,1 V	0.55	0.85	10,20	560
APSD00060530680□00	68	2.52 MHz,1 V	0.65	0.8	10,20	680
APSD00060530820□00	82	2.52 MHz,1 V	0.8	0.65	10,20	820
APSD00060530101□00	100	1 kHz,1 V	0.9	0.6	10,20	101
APSD00060530121□00	120	1 kHz,1 V	1	0.58	10,20	121
APSD00060530151□00	150	1 kHz,1 V	1.3	0.43	10,20	151
APSD00060530181□00	180	1 kHz,1 V	1.5	0.41	10,20	181
APSD00060530221□00	220	1 kHz,1 V	2	0.38	10,20	221
APSD00060530271□00	270	1 kHz,1 V	2.5	0.35	10,20	271
APSD00060530331□00	330	1 kHz,1 V	3.2	0.28	10,20	331
APSD00060530391□00	390	1 kHz,1 V	3.5	0.26	10,20	391
APSD00060530471□00	470	1 kHz,1 V	4.2	0.2	10,20	471
APSD00060530561□00	560	1 kHz,1 V	4.5	0.19	10,20	561

Note: When ordering, please specify tolerance code. Tolerance: K=±10% / M=±20%

1. Operating temperature range -40°C~125°C(Including self - temperature rise)
2. Isat for Inductance drop 10% from its value without current
3. Measure Equipment:
L: Agilent E4980 or HP4284A (over 1MHz), HP4285A (under 1MHz)
RDC: Chroma 16502

Please be sure to request approval specifications that provide further details of the products. Kindly note that the content of these specifications are subject to change or may be discontinued without prior notice. This product may not be designed/used in medical or high risk applications without Chilisin approval. Please contact our sales department before ordering.

APSD00060530 Type

■ Dimensions

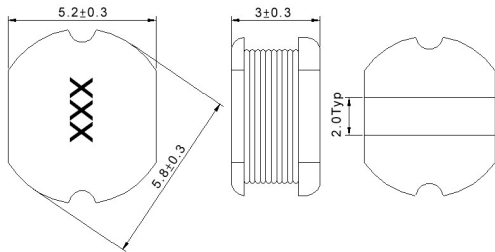

unit:mm

■ Recommended Land Pattern

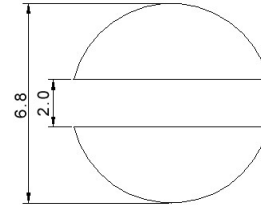

unit:mm

■ Electrical Characteristics

Part No.	Inductance (uH)	Test Freq.	RDC (Ω)Max.	Isat (A)	Tolerance (±%)	Marking
APSD00060530681□00	680	1 kHz,1 V	6.5	0.18	10,20	681
APSD00060530821□00	820	1 kHz,1 V	7.5	0.15	10,20	821
APSD00060530102□00	1000	1 kHz,1 V	8	0.13	10,20	102

Note: When ordering, please specify tolerance code. Tolerance: K=±10% / M=±20%

1. Operating temperature range -40°C~125°C(Including self - temperature rise)
2. Isat for Inductance drop 10% from its value without current
3. Measure Equipment:
L: Agilent E4980 or HP4284A (over 1MHz), HP4285A (under 1MHz)
RDC: Chroma 16502
Isat: HP4284+42841A or WK3260B+WK3265B

APSD00060530 Type

Characteristics Graph

Inductance vs. Frequency Charateristics

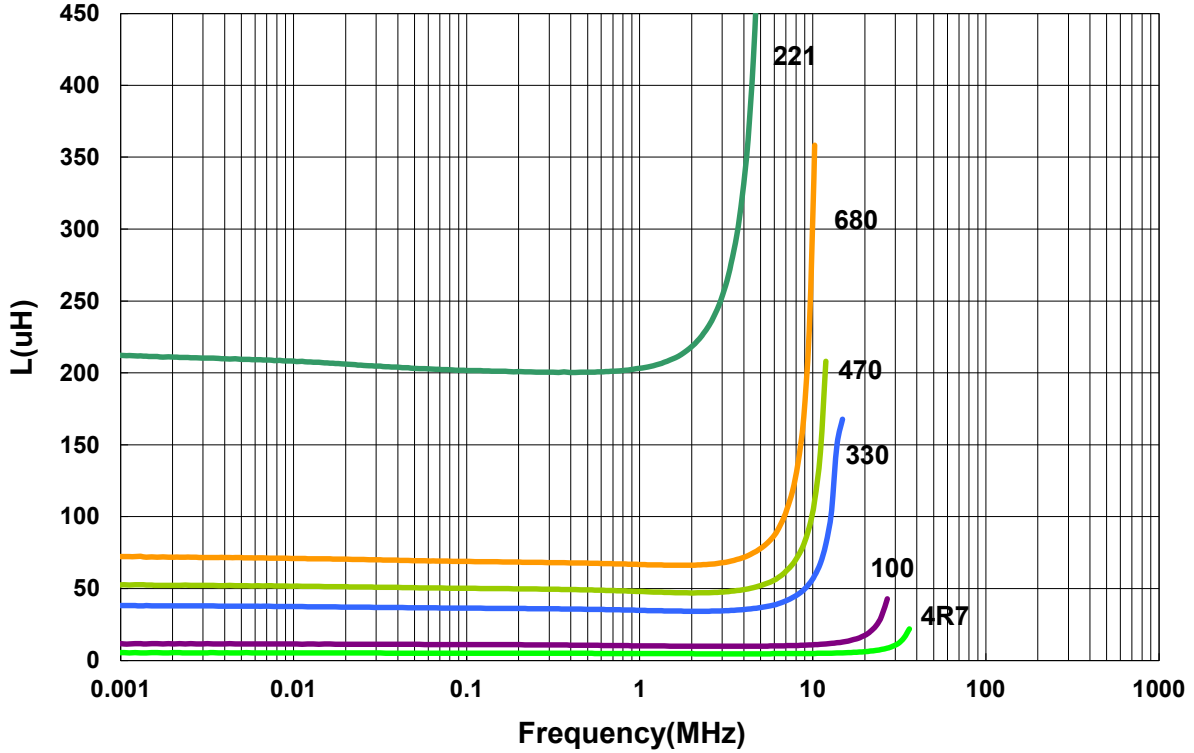

Inductance vs. DC Current

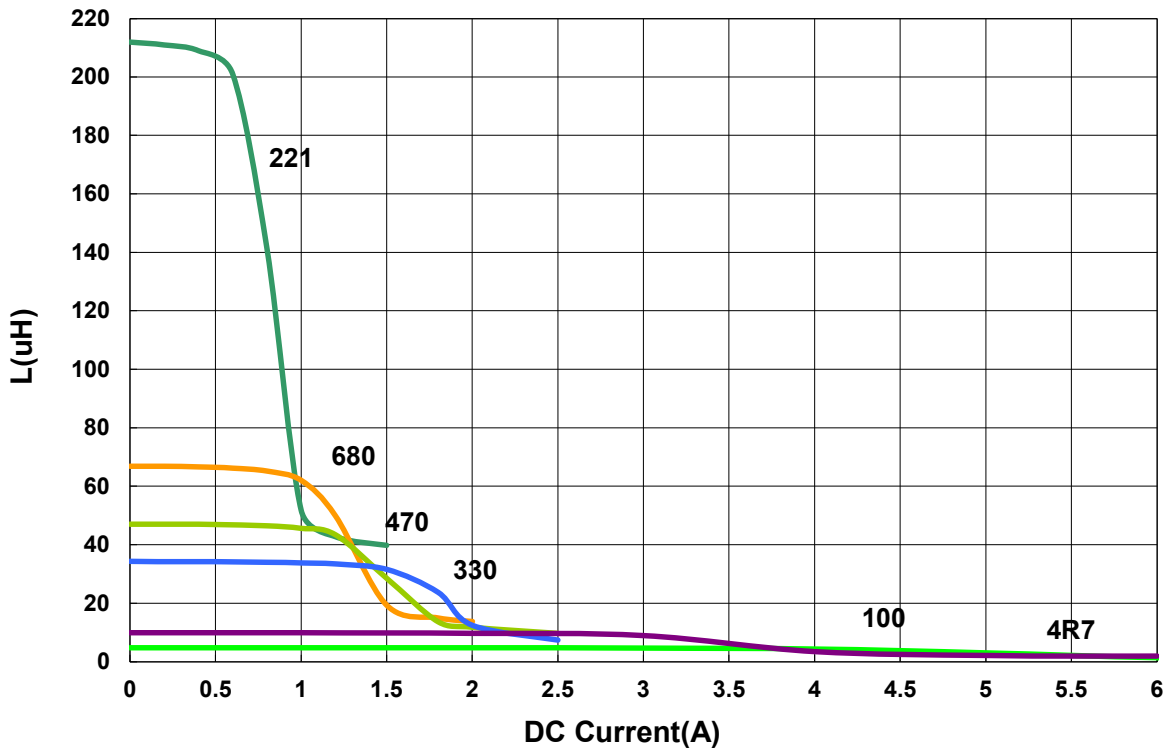

Please be sure to request approval specifications that provide further details of the products. Kindly note that the content of these specifications are subject to change or may be discontinued without prior notice. This product may not be designed/used in medical or high risk applications without Chilisin approval. Please contact our sales department before ordering.

APSD00060545 Type

Dimensions

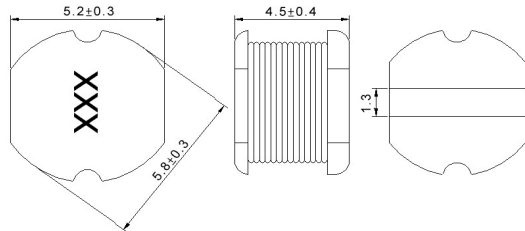

unit:mm

Recommended Land Pattern

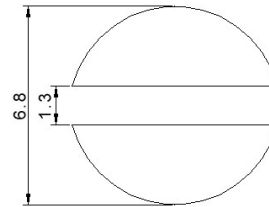

unit:mm

Electrical Characteristics

Part No.	Inductance (uH)	Test Freq.	RDC (Ω)Max.	Isat (A)	Tolerance (±%)	Marking
APSD000605451R8□00	1.8	7.96 MHz,1 V	0.02	3.5	20	1R8
APSD000605452R2□00	2.2	7.96 MHz,1 V	0.023	3.2	20	2R2
APSD000605453R3□00	3.3	7.96 MHz,1 V	0.0314	2.59	10,20	3R3
APSD000605453R5□00	3.5	7.96 MHz,1 V	0.03	2.4	20	3R5
APSD000605454R7□00	4.7	7.96 MHz,1 V	0.0372	2.3	10,20	4R7
APSD000605456R8□00	6.8	7.96 MHz,1 V	0.057	1.8	20	6R8
APSD000605458R2□00	8.2	7.96 MHz,1 V	0.0594	1.7	20	8R2
APSD00060545100□00	10	2.52 MHz,1 V	0.1	1.44	10,20	100
APSD00060545120□00	12	2.52 MHz,1 V	0.12	1.4	20	120
APSD00060545150□00	15	2.52 MHz,1 V	0.14	1.3	10,20	150
APSD00060545180□00	18	2.52 MHz,1 V	0.15	1.23	20	180
APSD00060545220□00	22	2.52 MHz,1 V	0.18	1.11	20	220
APSD00060545270□00	27	2.52 MHz,1 V	0.2	0.97	20	270
APSD00060545330□00	33	2.52 MHz,1 V	0.23	0.88	10,20	330
APSD00060545390□00	39	2.52 MHz,1 V	0.32	0.8	10,20	390
APSD00060545470□00	47	2.52 MHz,1 V	0.37	0.72	10,20	470
APSD00060545560□00	56	2.52 MHz,1 V	0.42	0.68	10,20	560
APSD00060545680□00	68	2.52 MHz,1 V	0.46	0.61	10,20	680
APSD00060545820□00	82	2.52 MHz,1 V	0.6	0.58	10,20	820
APSD00060545101□00	100	1 kHz,1 V	0.7	0.52	10,20	101
APSD00060545121□00	120	1 kHz,1 V	0.93	0.48	10,20	121
APSD00060545151□00	150	1 kHz,1 V	1.1	0.4	10,20	151
APSD00060545181□00	180	1 kHz,1 V	1.38	0.38	10,20	181
APSD00060545221□00	220	1 kHz,1 V	1.57	0.35	10,20	221
APSD00060545271□00	270	1 kHz,1 V	1.85	0.29	10,20	271
APSD00060545331□00	330	1 kHz,1 V	2	0.28	10,20	331
APSD00060545391□00	390	1 kHz,1 V	2.6	0.26	10,20	391
APSD00060545471□00	470	1 kHz,1 V	3	0.12	10,20	471
APSD00060545561□00	560	1 kHz,1 V	4.19	0.1	10,20	561
APSD00060545681□00	680	1 kHz,1 V	4.44	0.08	10,20	681
APSD00060545821□00	820	1 kHz,1 V	5.12	0.05	10,20	821
APSD00060545102□00	1000	1 kHz,1 V	10	0.03	10,20	102

Note: When ordering, please specify tolerance code. Tolerance: K=±10% / M=±20%

- Operating temperature range -40°C~125°C(Including self - temperature rise)
- Isat for Inductance drop 10% from its value without current
- Measure Equipment:
L: Agilent E4980 or HP4284A (over 1MHz), HP4285A (under 1MHz)
RDC: Chroma 16502
Isat: HP4284+42841A or WK3260B+WK3265B

APSD00060545 Type

Characteristics Graph

Inductance vs. Frequency Characteristics

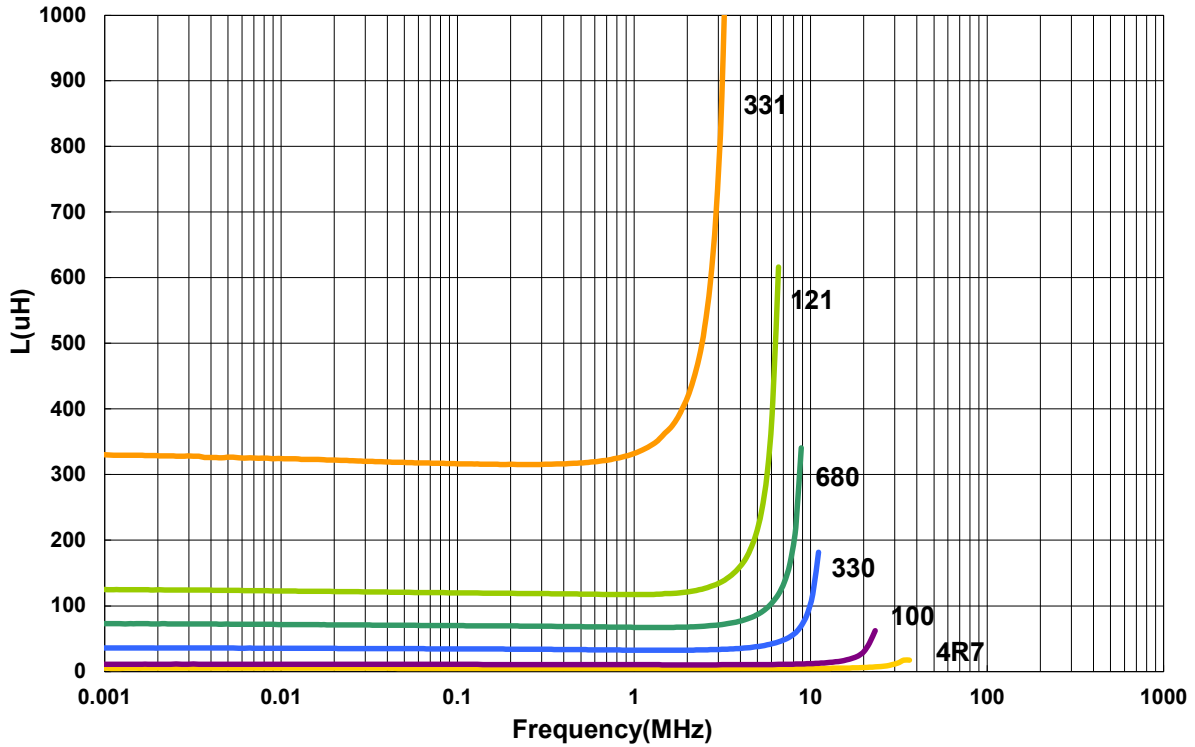

Inductance vs. DC Current

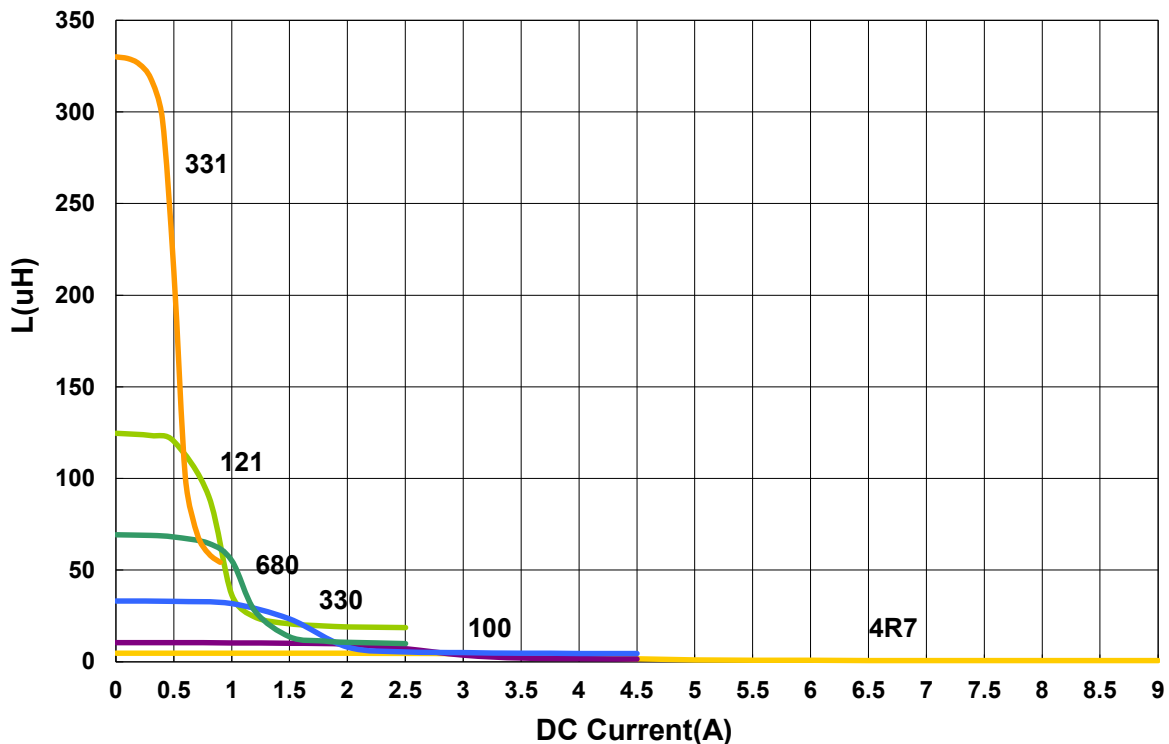

Please be sure to request approval specifications that provide further details of the products. Kindly note that the content of these specifications are subject to change or may be discontinued without prior notice. This product may not be designed/used in medical or high risk applications without Chilisin approval. Please contact our sales department before ordering.

APSD00080735 Type

■ Dimensions

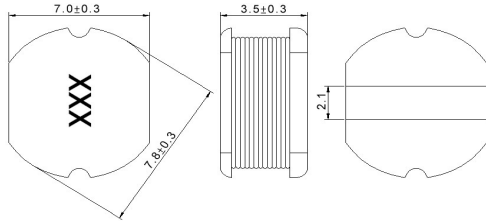

unit:mm

■ Recommended Land Pattern

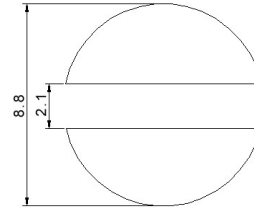

unit:mm

■ Electrical Characteristics

Part No.	Inductance (uH)	Test Freq.	RDC (Ω)Max.	Isat (A)	Tolerance (±%)	Marking
APSD000807352R2□00	2.2	7.96 MHz,1 V	0.03	3.2	20	2R2
APSD000807354R7□00	4.7	2.52 MHz,1 V	0.04	1.6	20	4R7
APSD00080735100□00	10	2.52 MHz,1 V	0.08	1.44	20	100
APSD00080735120□00	12	2.52 MHz,1 V	0.09	1.39	10,20	120
APSD00080735150□00	15	2.52 MHz,1 V	0.1	1.24	10,20	150
APSD00080735180□00	18	2.52 MHz,1 V	0.11	1.12	20	180
APSD00080735220□00	22	2.52 MHz,1 V	0.13	1.07	20	220
APSD00080735270□00	27	2.52 MHz,1 V	0.15	0.94	20	270
APSD00080735330□00	33	2.52 MHz,1 V	0.17	0.85	10,20	330
APSD00080735390□00	39	2.52 MHz,1 V	0.22	0.74	10,20	390
APSD00080735470□00	47	2.52 MHz,1 V	0.25	0.68	10,20	470
APSD00080735560□00	56	2.52 MHz,1 V	0.28	0.64	10,20	560
APSD00080735680□00	68	2.52 MHz,1 V	0.33	0.59	10,20	680
APSD00080735820□00	82	2.52 MHz,1 V	0.41	0.54	10,20	820
APSD00080735101□00	100	1 kHz,1 V	0.48	0.51	10,20	101
APSD00080735121□00	120	1 kHz,1 V	0.54	0.49	10,20	121
APSD00080735151□00	150	1 kHz,1 V	0.75	0.4	10,20	151
APSD00080735181□00	180	1 kHz,1 V	1.02	0.36	10,20	181
APSD00080735221□00	220	1 kHz,1 V	1.2	0.31	10,20	221
APSD00080735271□00	270	1 kHz,1 V	1.31	0.29	10,20	271
APSD00080735331□00	330	1 kHz,1 V	1.5	0.28	10,20	331
APSD00080735561□00	560	1 kHz,1 V	2.5	0.14	10,20	561

Note: When ordering, please specify tolerance code. Tolerance: K=±10% / M=±20%

1. Operating temperature range -40°C~125°C(Including self - temperature rise)
2. Isat for Inductance drop 10% from its value without current
3. Measure Equipment:
L: Agilent E4980 or HP4284A (over 1MHz), HP4285A (under 1MHz)
RDC: Chroma 16502
Isat: HP4284+42841A or WK3260B+WK3265B

APSD00080735 Type

■ **Characteristics Graph**

Inductance vs. Frequency Charateristics

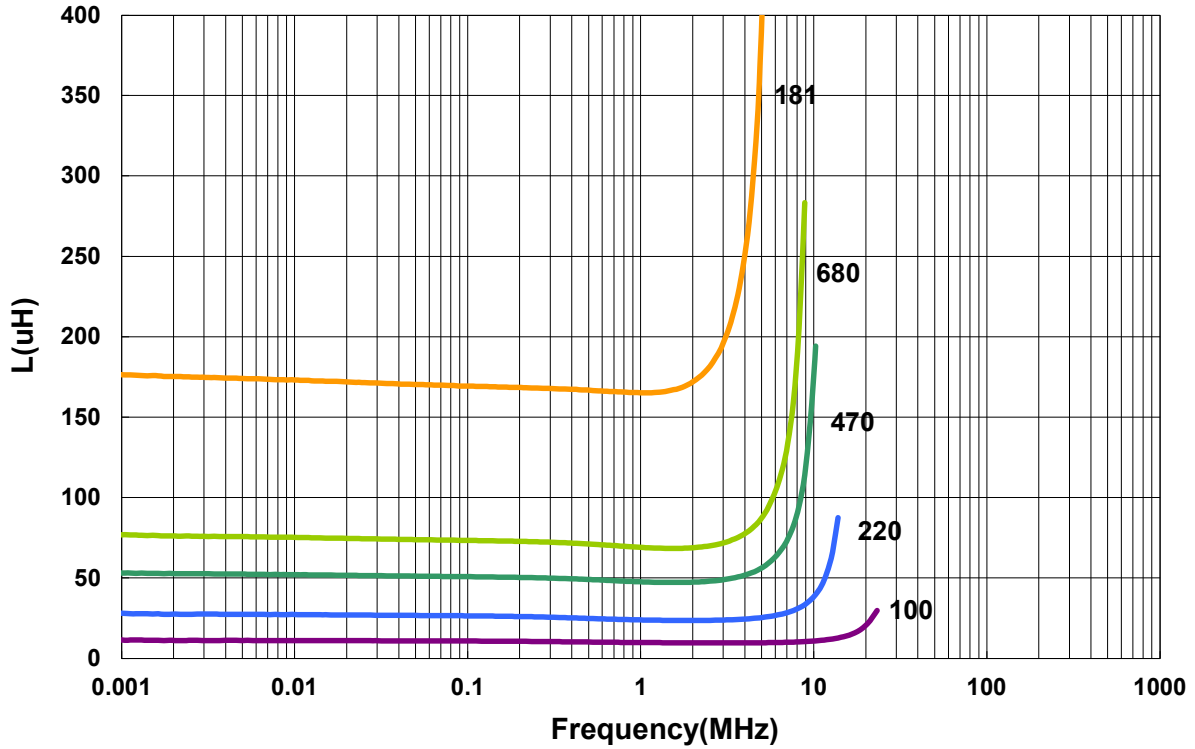

Inductance vs. DC Current

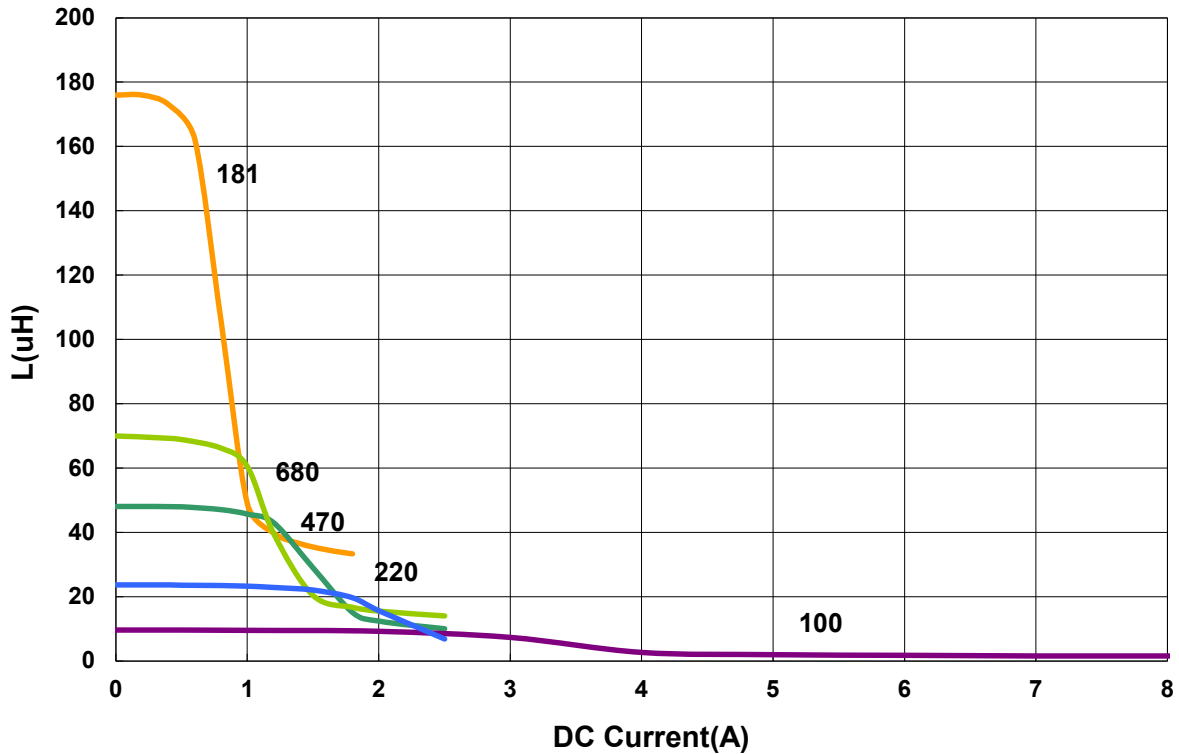

Please be sure to request approval specifications that provide further details of the products. Kindly note that the content of these specifications are subject to change or may be discontinued without prior notice. This product may not be designed/used in medical or high risk applications without Chilisin approval. Please contact our sales department before ordering.

APSD00080750 Type

Dimensions

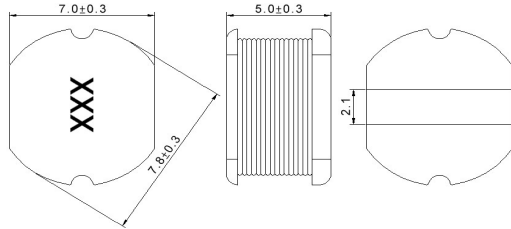

unit:mm

Recommended Land Pattern

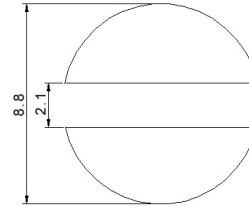

unit:mm

Electrical Characteristics

Part No.	Inductance (uH)	Test Freq.	RDC (Ω)Max.	Isat (A)	Tolerance (±%)	Marking
APSD000807501R4□00	1.4	7.96 MHz,1 V	0.02	3.7	20	1R4
APSD000807501R5□00	1.5	7.96 MHz,1 V	0.02	3.7	20	1R5
APSD000807501R8□00	1.8	7.96 MHz,1 V	0.02	3.7	20	1R8
APSD000807502R2□00	2.2	7.96 MHz,1 V	0.02	3.7	20	2R2
APSD000807502R7□00	2.7	7.96 MHz,1 V	0.02	3.7	20	2R7
APSD000807503R0□00	3	7.96 MHz,1 V	0.025	3.7	20	3R0
APSD000807503R3□00	3.3	7.96 MHz,1 V	0.03	3.7	20	3R3
APSD000807503R6□00	3.6	7.96 MHz,1 V	0.03	3.7	20	3R6
APSD000807503R9□00	3.9	7.96 MHz,1 V	0.03	3.7	20	3R9
APSD000807504R7□00	4.7	7.96 MHz,1 V	0.04	3.5	10,20	4R7
APSD000807505R6□00	5.6	7.96 MHz,1 V	0.04	3.3	20	5R6
APSD000807506R8□00	6.8	7.96 MHz,1 V	0.04	3.1	20	6R8
APSD000807508R2□00	8.2	7.96 MHz,1 V	0.05	2.7	20	8R2
APSD00080750100□00	10	2.52 MHz,1 V	0.07	2.3	10,20	100
APSD00080750120□00	12	2.52 MHz,1 V	0.08	2	20	120
APSD00080750150□00	15	2.52 MHz,1 V	0.09	1.8	10,20	150
APSD00080750180□00	18	2.52 MHz,1 V	0.1	1.6	20	180
APSD00080750220□00	22	2.52 MHz,1 V	0.11	1.5	10,20	220
APSD00080750270□00	27	2.52 MHz,1 V	0.12	1.3	20	270
APSD00080750330□00	33	2.52 MHz,1 V	0.13	1.2	10,20	330
APSD00080750390□00	39	2.52 MHz,1 V	0.16	1.1	10,20	390
APSD00080750470□00	47	2.52 MHz,1 V	0.18	1.1	10,20	470
APSD00080750560□00	56	2.52 MHz,1 V	0.24	0.94	10,20	560
APSD00080750680□00	68	2.52 MHz,1 V	0.28	0.85	10,20	680
APSD00080750820□00	82	2.52 MHz,1 V	0.37	0.78	10,20	820
APSD00080750101□00	100	1 kHz,1 V	0.43	0.72	10,20	101
APSD00080750121□00	120	1 kHz,1 V	0.47	0.66	10,20	121
APSD00080750151□00	150	1 kHz,1 V	0.64	0.58	10,20	151
APSD00080750181□00	180	1 kHz,1 V	0.71	0.51	10,20	181
APSD00080750221□00	220	1 kHz,1 V	0.96	0.49	10,20	221

Note: When ordering, please specify tolerance code. Tolerance: K=±10% / M=±20%

1. Operating temperature range -40°C ~ 125°C (Including self - temperature rise)
2. Isat for Inductance drop 10% from its value without current
3. Measure Equipment:
L: Agilent E4980 or HP4284A (over 1MHz), HP4285A (under 1MHz)
RDC: Chroma 16502
Isat: HP4284+42841A or WK3260B+WK3265B

APSD00080750 Type

■ Dimensions

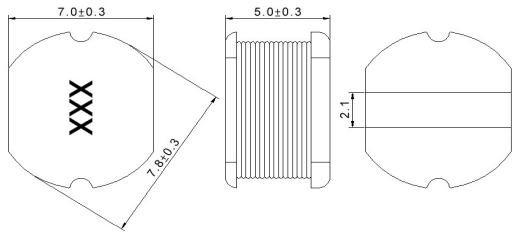

unit:mm

■ Recommended Land Pattern

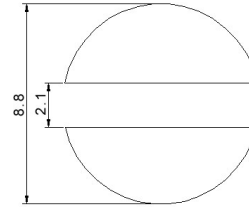

unit:mm

■ Electrical Characteristics

Part No.	Inductance (uH)	Test Freq.	RDC (Ω)Max.	Isat (A)	Tolerance (±%)	Marking
APSD00080750271□00	270	1 kHz,1 V	1.11	0.42	10,20	271
APSD00080750331□00	330	1 kHz,1 V	1.26	0.4	10,20	331
APSD00080750391□00	390	1 kHz,1 V	1.77	0.36	10,20	391
APSD00080750471□00	470	1 kHz,1 V	1.96	0.34	10,20	471
APSD00080750561□00	560	1 kHz,1 V	2.41	0.32	10,20	561
APSD00080750681□00	680	1 kHz,1 V	2.5	0.29	10,20	681
APSD00080750102□00	1000	1 kHz,1 V	2.8	0.19	10,20	102

Note: When ordering, please specify tolerance code. Tolerance: K=±10% / M=±20%

1. Operating temperature range —40°C ~ 125°C (Including self - temperature rise)
2. Isat for Inductance drop 10% from its value without current
3. Measure Equipment:
L: Agilent E4980 or HP4284A (over 1MHz), HP4285A (under 1MHz)
RDC: Chroma 16502
Isat: HP4284+42841A or WK3260B+WK3265B

APSD00080750 Type

Characteristics Graph

Inductance vs. Frequency Charateristics

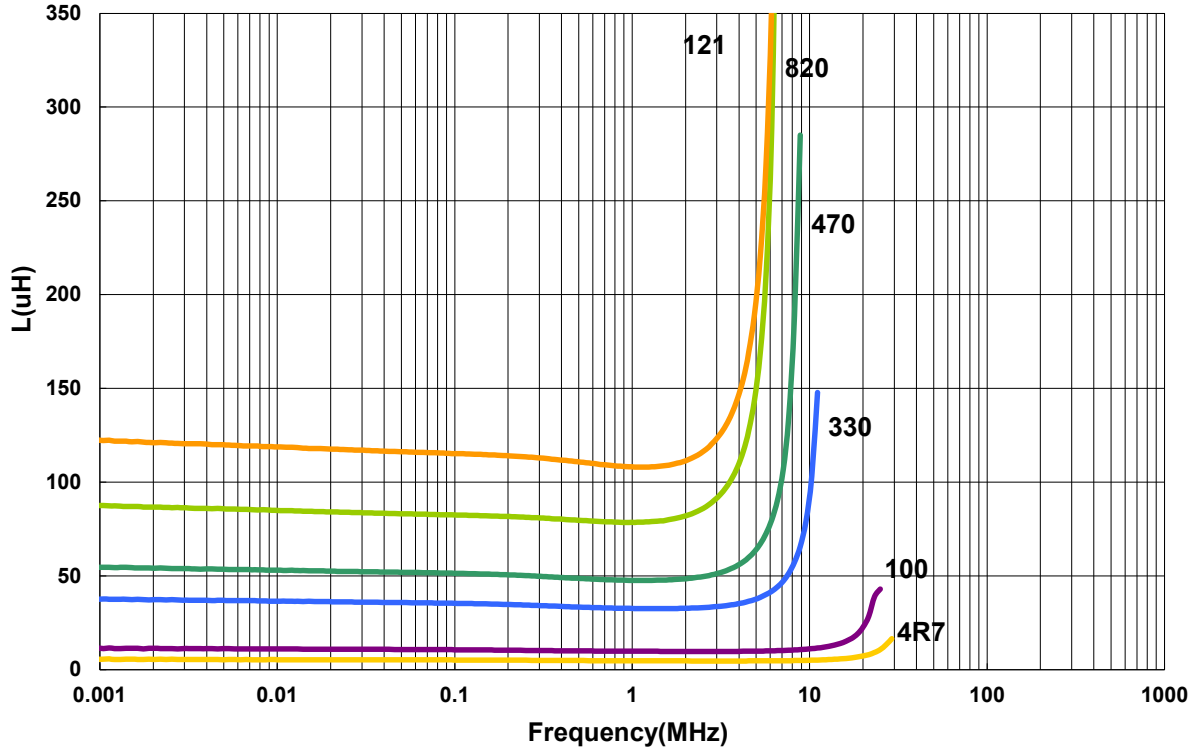

Inductance vs. DC Current

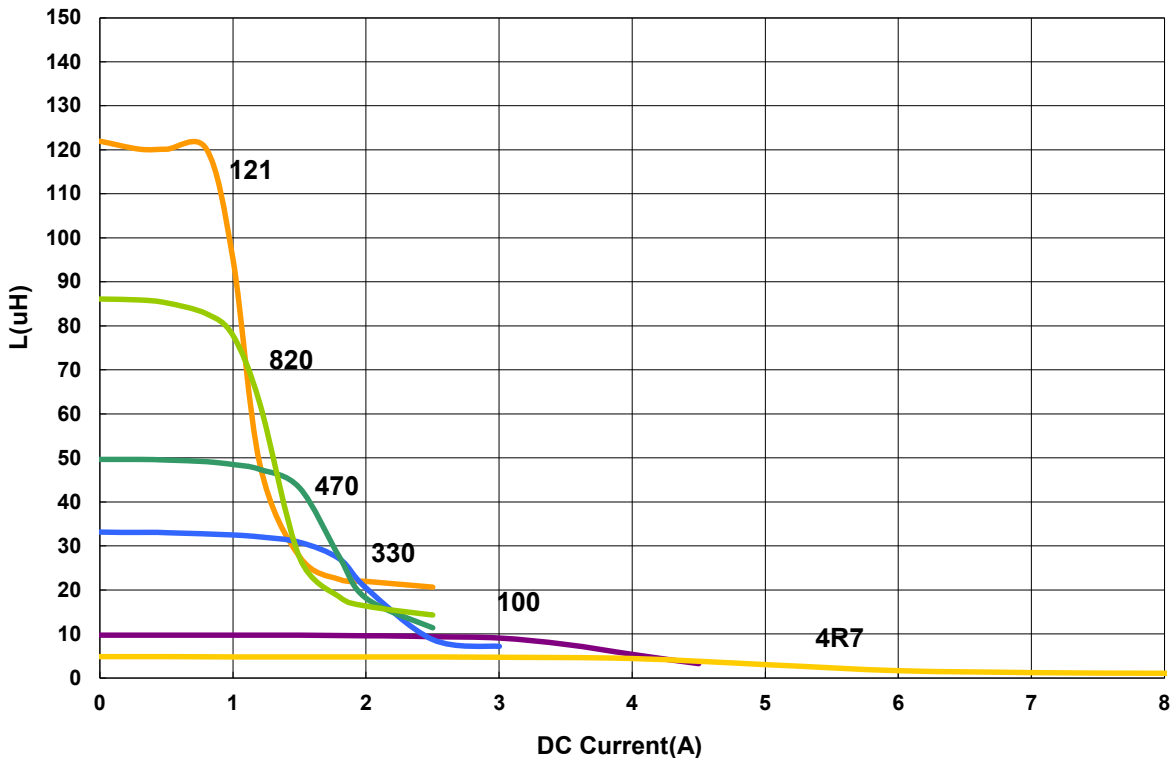

Please be sure to request approval specifications that provide further details of the products. Kindly note that the content of these specifications are subject to change or may be discontinued without prior notice. This product may not be designed/used in medical or high risk applications without Chilisin approval. Please contact our sales department before ordering.

■ Packaging

Tape Dimensions

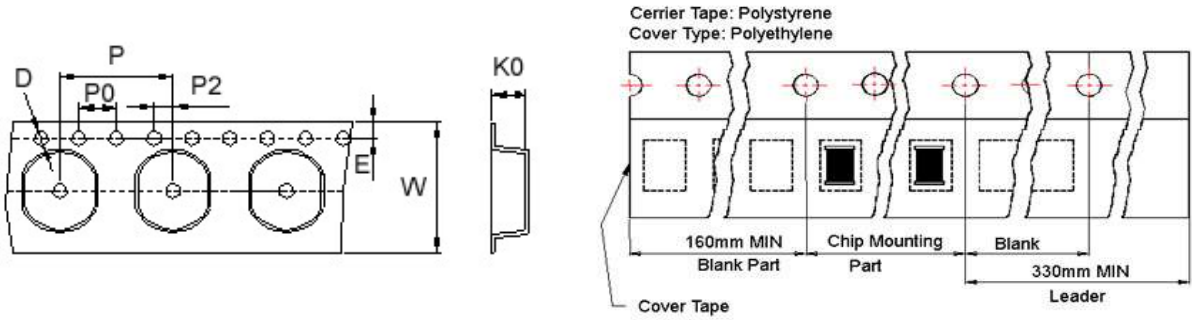

Reel Dimensions

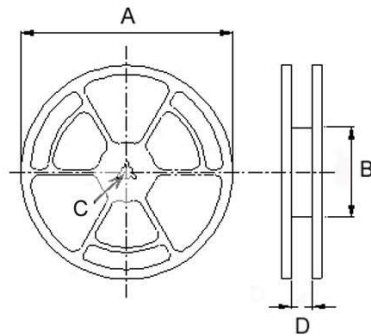

Dimensions in mm

TYPE	Tape Dimensions							Reel Dimensions				Quantity PCS / REEL
	K0	D	E	W	P	P0	P2	A	B	C	D	
APSD00030321	2.5	1.55	1.75	12	8	4	2	330	100	13	13.4	3000
APSD00050432	3.55	1.55	1.75	12	8	4	2	330	100	13	13.4	2000
APSD00060530	3.3	1.5	1.75	16	8	4	2	330	100	13	17.4	2000
APSD00060545	4.8	1.55	1.75	16	8	4	2	330	100	13	17.4	1500
APSD00080735	3.8	1.55	1.75	16	12	4	2	330	100	13	17.4	1000
APSD00080750	5.2	1.55	1.75	16	12	4	2	330	100	13	17.4	700