

Quad Port 10/100BASE-T LAN Transformer for Auto MDI/MDIX Extended Temperature



27.55 x 16.20 x 7.35mm

ALAN-409

RoHS/RoHS II Compliant

FEATURES:

- Meet IEEE802.3 specification
- Extended Temperature (-40°C - +85°C)
- ROHS peak reflow temperature rating 240°C
- 1500Vrms Hi-Pot

APPLICATIONS:

- Designed for most leading PHY IC manufacturers such as Broadcom, Marvell, Micrel, & Microsemi
- 10/100Base-T Ethernet-LAN
- VoIP
- Symmetrical Tx & RX channels for Auto MDI/MDIX capability
- Provides signal conditioning, EMI suppression and signal isolation.
- Hubs/Switches/Routers/Servers/NIC Cards

STANDARD SPECIFICATIONS:

Parameters	Minimum	Typical	Maximum	Units	Notes
Operating Temperature	-40		+85	°C	
Storage Temperature	-40		+85	°C	
Turn Ratio (± 2%)		1CT:1CT			
Inductance (OCL)	350			μH	100KHz/0.1V@8mA
Leakage Inductance (LL)			0.5	μH	100KHz/0.1V
Cw/w		30		pF	100KHz/0.1V
DC Resistance			1.2	Ω	
Insertion Loss			-1.0	dB	0.1-100MHz
Return Loss	-18			dB	2-30MHz
	-14.4				40MHz
	-13.1				50MHz
	-12				60-80MHz
Cross Talk	-55			dB	1MHz
	-40				30MHz
	-35				60MHz
	-30				100MHz
Differential to Common Mode Rejection	-30			dB	1-100MHz
Common Mode Rejection	-35			dB	1-60MHz
	-25				60-200MHz
Hi-Pot	1500Vrms				

OUTLINE DIMENSIONS:

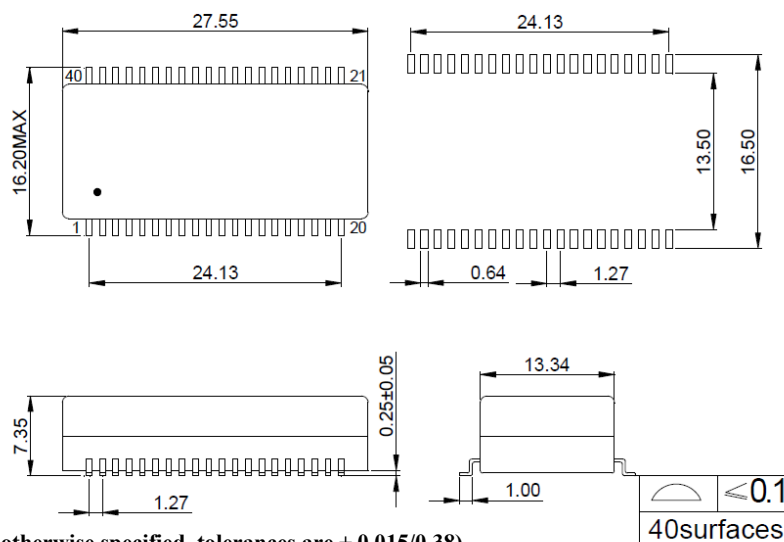

Dimensions: inch/mm (Unless otherwise specified, tolerances are ± 0.015/0.38)

ABRACON IS
ISO9001:2008
CERTIFIED

ABRACON[®]
The Power of Linking Together LLC

2 Faraday, Suite# B | Irvine | CA 92618 Revised: 03.25.15
Ph. 949.546.8000 | Fax. 949.546.8001
Visit www.abracon.com for Terms and Conditions of Sale

Quad Port 10/100BASE-T LAN Transformer for Auto MDI/MDIX Extended Temperature



27.55 x 16.20 x 7.35mm

ALAN-409

RoHS/RoHS II Compliant

SCHEMATICS

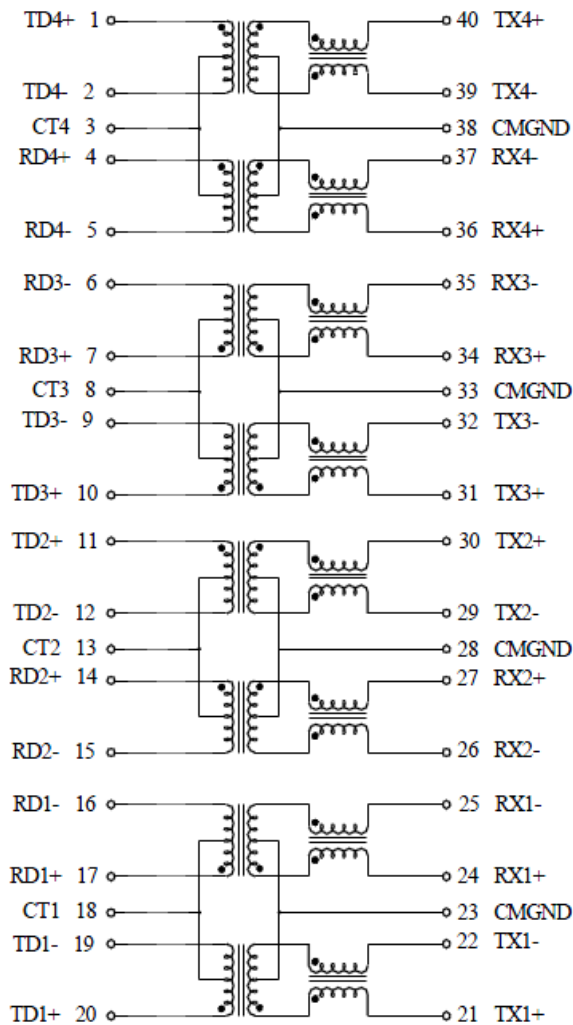

REFLOW PROFILE:

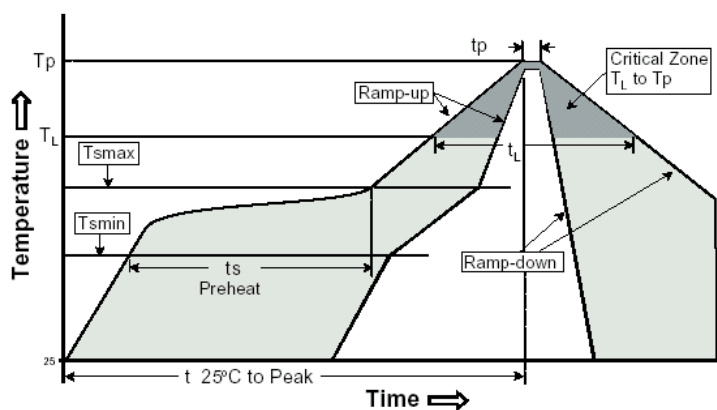

Profile Feature	Pb-Free Assembly
Average Ramp-Up Rate ($T_{s\ max}$ to T_p)	3°C /second max.
Preheat -Temperature Min ($T_{s\ min}$) -Temperature Max ($T_{s\ max}$) -Time ($t_{s\ min}$ to $t_{s\ max}$)	150°C 200°C 60-120 seconds
Time maintained above: -Temperature (T_L) -Time (t_L)	217°C 60-150 seconds
Peak/Classification Temperature (T_p)	240±5°C
Time within 5°C of actual Peak Temperature (t_p)	20-40 seconds
Ramp-Down Rate	6°C /seconds max
Time 25°C to Peak Temperature	8 minutes max.

ABRACON IS
ISO9001:2008
CERTIFIED

ABRACON[®]
The Power of Linking Together LLC

2 Faraday, Suite# B | Irvine | CA 92618 **Revised: 03.25.15**
Ph. 949.546.8000 | Fax. 949.546.8001
Visit www.abracon.com for Terms and Conditions of Sale

Quad Port 10/100BASE-T LAN Transformer for Auto MDI/MDIX Extended Temperature



27.55 x 16.20 x 7.35mm

ALAN-409

RoHS/RoHS II Compliant

TAPE & REEL:

Packing 400 pcs / reel
Weight 2.7 grams / pcs



Mechanicals

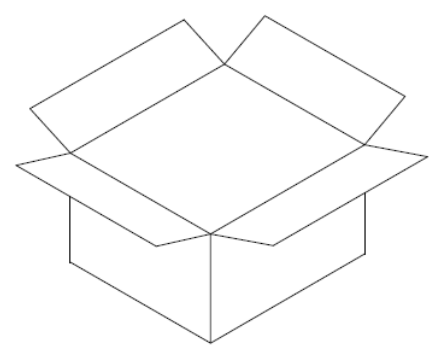
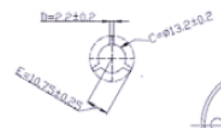
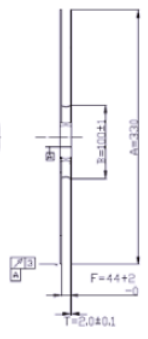
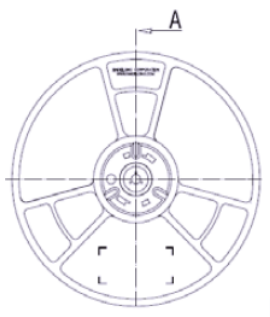
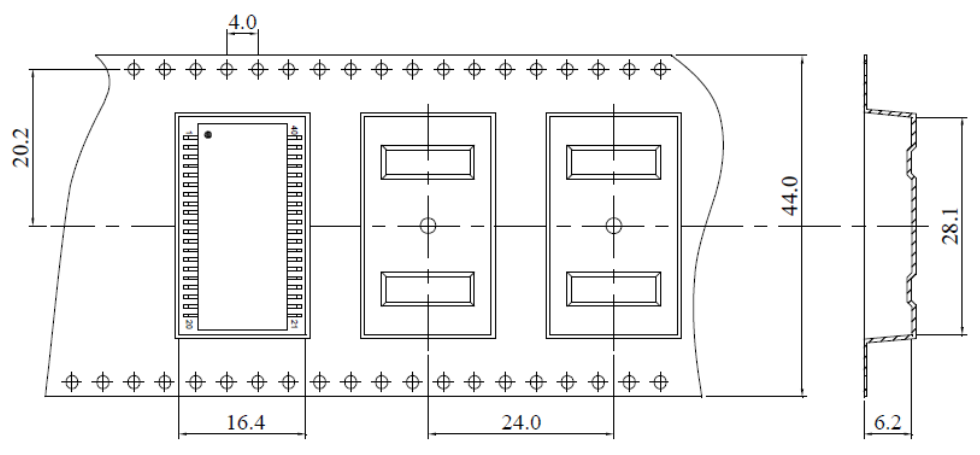

Dimensions: mm

ATTENTION: Abracon Corporation's products are COTS – Commercial-Off-The-Shelf products; suitable for Commercial, Industrial and, where designated, Automotive Applications. Abracon's products are not specifically designed for Military, Aviation, Aerospace, Life-dependant Medical applications or any application requiring high reliability where component failure could result in loss of life and/or property. For applications requiring high reliability and/or presenting an extreme operating environment, written consent and authorization from Abracon Corporation is required. Please contact Abracon Corporation for more information.

ABRACON IS
ISO9001:2008
CERTIFIED



2 Faraday, Suite# B | Irvine | CA 92618 Revised: 03.25.15
Ph. 949.546.8000 | Fax. 949.546.8001
Visit www.abracon.com for Terms and Conditions of Sale