

Automotive Signal Common Mode Chokes



ACMS-Q6527E

Request Samples



Check Inventory



6.5 x 4.5 x 2.7 mm
RoHS/RoHS II Compliant
MSL Level = 1

Features

- AEC-Q200 compliant, Grade 1
- PPAP ready and supported
- Manufactured in TS/IATF 16949 production lines
- Excellent impedance characteristics

Applications

- Differential signal line common mode noise suppression.
- Multimedia devices
- Automotive applications such as ADAS, Infotainment, Sensing, TCU
- Automotive Ethernet

Electrical Specifications

Part Number	Inductance (μH)	Rated Current (A)	DCR (Ω)	Insertion loss (dB) Max		Return Loss (dB) Min		
	Typ.	Max	Max	100 MHz	1-60 MHz	1-10 MHz	30 MHz	60 MHz
ACMS-Q6527E-101	100	0.35	2.0	-3.0	-1.0	-28	-23	-18
	Common Mode Rejection (dB) Min				Differential to Common Mode Rejection (dB) Min			
	1 MHz	10 MHz	60-100 MHz	200-1000 MHz	1-10 MHz	100 MHz	1000 MHz	
	-18	-35	-43	-30	-70	-50	-25	

Rated Current is based on an Irms temperature rise of 40°C.

Inductance Test Condition: 0.1V/100KHz

ACMS-Q6527E is AEC-Q200 Automotive certified.

ACMS-Q6527E Series is RoHS Compliant and Pb free.

Operating Temperature: -40°C to +125°C (Including self-heating)

Storage Temperature (on PCB): -40°C to +125°C.

Storage (in original packaging): <40°C, <60% RH.



5101 Hidden Creek Ln, Spicewood TX 78669
Phone: 512-371-6159 Fax: 512-351-8858
For terms and conditions of sales, please visit:
www.abracon.com

REVISION A 8/25/2023

ABRACON IS
ISO9001-2015
CERTIFIED

Automotive Signal Common Mode Chokes



ACMS-Q6527E

Request Samples



Check Inventory



6.5 x 4.5 x 2.7 mm
 RoHS/RoHS II Compliant
 MSL Level = 1

Mechanical Specifications

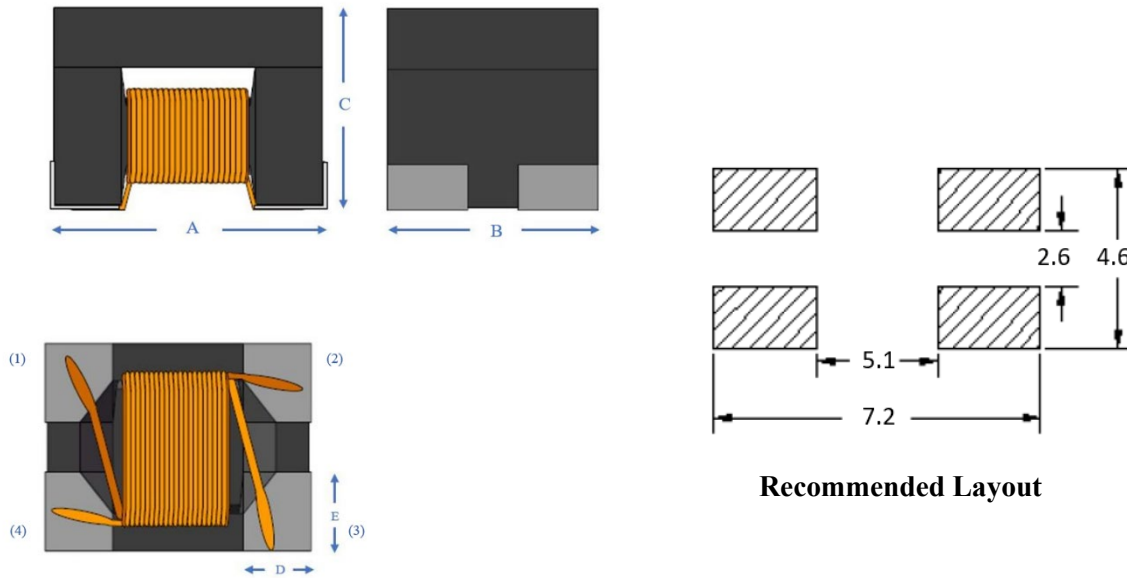

Recommended Layout

A	B	C	D	E
6.5 ±0.3	4.5 ±0.2	2.7 ±0.2	0.88 ±0.2	0.9 ±0.2

Dimensions: mm

Schematic

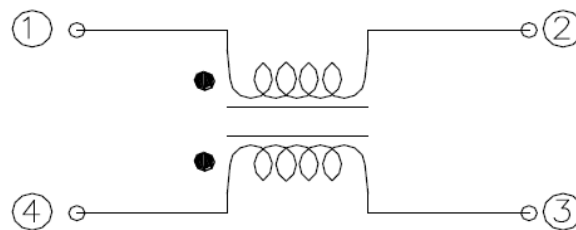

Automotive Signal Common Mode Chokes



ACMS-Q6527E

Request Samples



Check Inventory



6.5 x 4.5 x 2.7 mm
RoHS/RoHS II Compliant
 MSL Level = 1

Materials

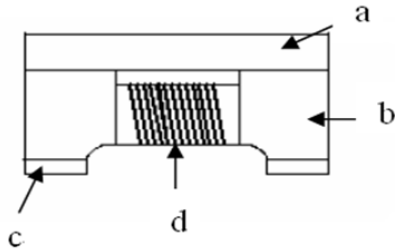

	Description	Specification
a	Upper Plate	Ferrite
b	Core	Ferrite Core
c	Electrode	Ag/Ni/Sn
d	Wire	Enameled Copper Wire

Part Identification

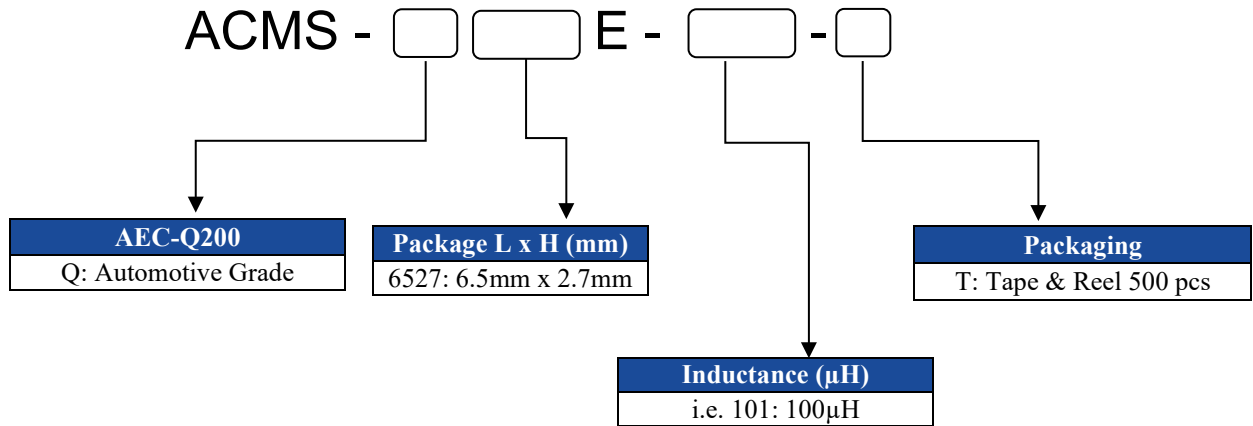

Automotive Signal Common Mode Chokes



ACMS-Q6527E

Request Samples



Check Inventory



6.5 x 4.5 x 2.7 mm
RoHS/RoHS II Compliant
MSL Level = 1

Reflow Profile

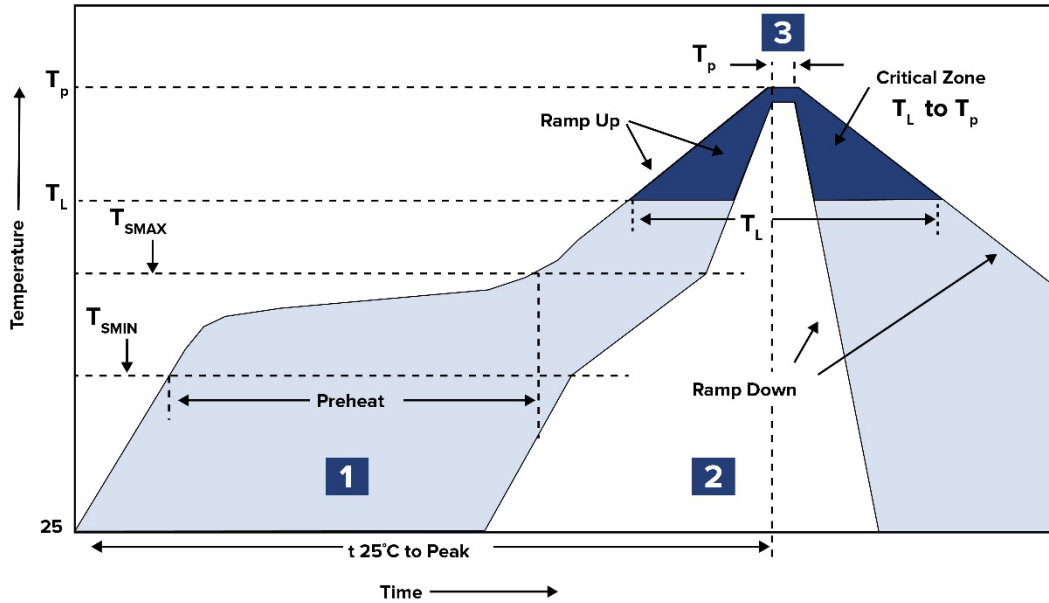

Zone	Description	Temperature	Times
1	Preheat	$T_{SMIN} \sim T_{SMAX}$ 150°C ~ 200°C	60 ~ 180 sec.
2	Reflow	T_L 217°C	60 ~ 150 sec.
3	Peak heat	T_P 250°C ±5°C	10 sec. MAX

Automotive Signal Common Mode Chokes



ACMS-Q6527E

Request Samples



Check Inventory



6.5 x 4.5 x 2.7 mm
RoHS/RoHS II Compliant
MSL Level = 1

Packaging

Tape & Reel: 500pcs/reel

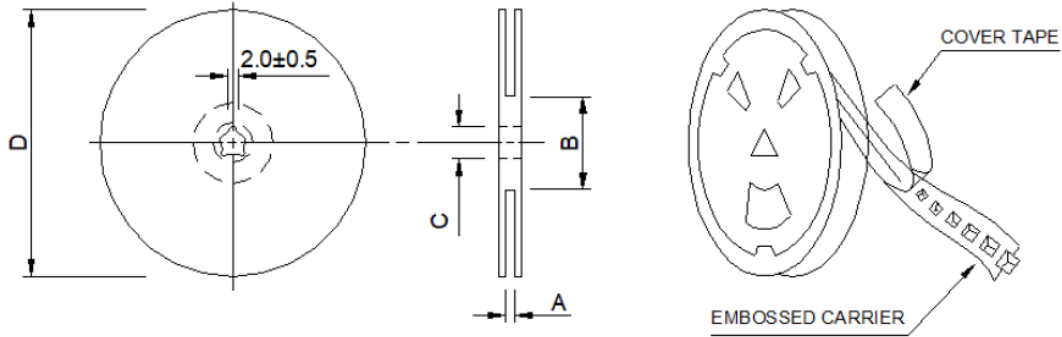

Series	A	B	C	D
ACMS-Q6527E	16.7 ±0.5	60.0 ±2.0	13.5 ±0.5	178 ±2.0

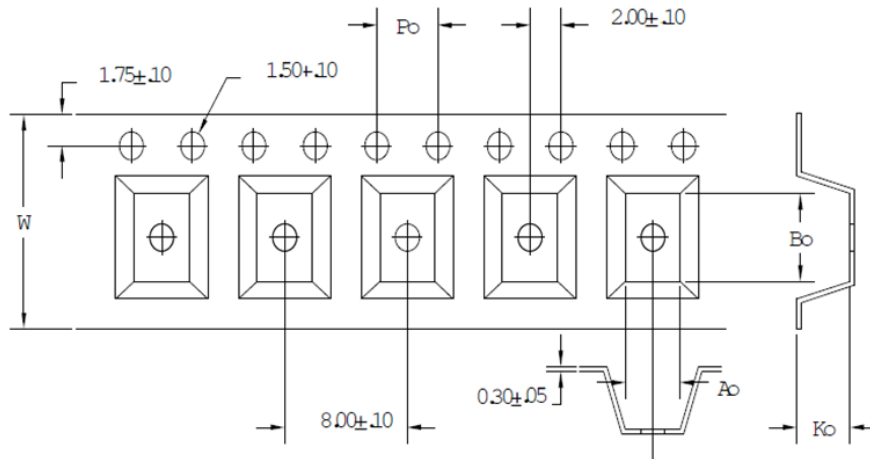

W	P0	Bo	Ao	Ko
16.0 ±0.30	4.0 ±0.10	6.9 ±0.10	4.9 ±0.10	2.9 ±0.10

Dimensions: mm

ATTENTION: Abracon LLC's products are COTS – Commercial-Off-The-Shelf products; suitable for Commercial, Industrial and, where designated, Automotive Applications. Abracon's products are not specifically designed for Military, Aviation, Aerospace, Life-dependent Medical applications or any application requiring high reliability where component failure could result in loss of life and/or property. For applications requiring high reliability and/or presenting an extreme operating environment, written consent and authorization from Abracon LLC is required. Please contact Abracon LLC for more information.



5101 Hidden Creek Ln, Spicewood TX 78669
Phone: 512-371-6159 Fax: 512-351-8858
For terms and conditions of sales, please visit:
www.abracon.com

REVISION A 8/25/2023

ABRACON IS
ISO9001-2015
CERTIFIED