

| DATE | REV | ECN | APP'D. BY |
|---------|-----|-------|-----------|
| 1-7-15 | A7 | 10172 | TRM |
| 3-16-16 | A8 | 10619 | TRM |
| | | | |
| | | | |

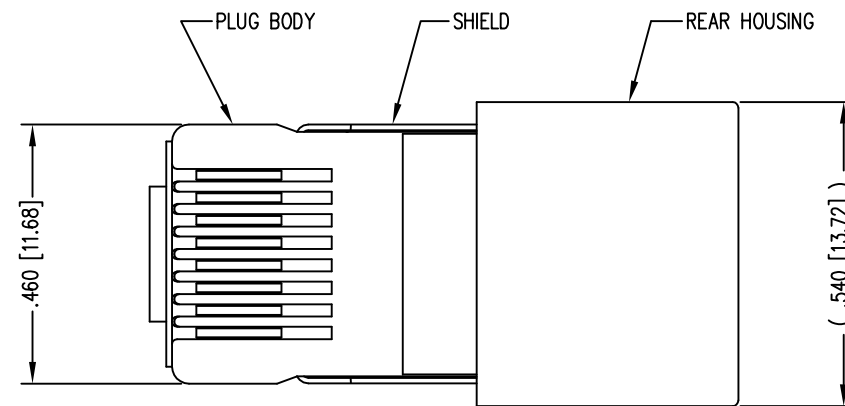

(SHOWN ASSEMBLED)

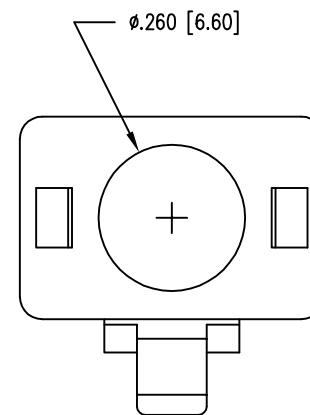
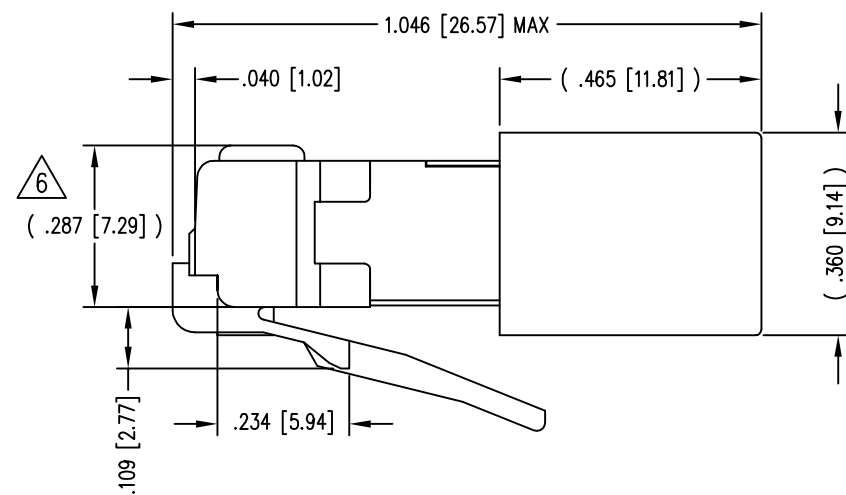
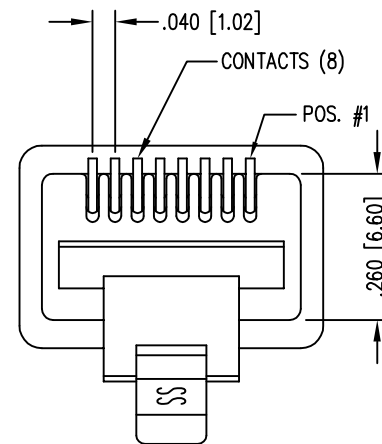

NOTES:

- 1- PLUG KIT CONSISTS OF :
PRE-INSERTED PLUG HOUSING & SHIELD
MANAGEMENT BAR
REAR HOUSING
FERRULE
- 2- MATERIALS :
FRONT HOUSING PLASTIC : CLEAR POLYCARBONATE, UL 94-V0
MANAGEMENT BAR : CLEAR POLYCARBONATE, UL 94-V0
REAR HOUSING PLASTIC : BLACK POLYCARBONATE, UL 94-V0
SHIELD : TIN PLATED BRASS
CONTACTS : PHOSPHOR BRONZE, SELECTIVE GOLD PLATING
FERRULE : NICKEL OR TIN PLATED BRASS
- 3- CONTACTS TERMINATE STRANDED CONDUCTORS UP TO .037 [0.94] OUTSIDE DIAMETER OF INSULATION.
- 4- FOR PLUG SPECIFICATION SEE PRO26-01.
- 5- DIMENSIONS & TOLERANCES COMPLY WITH TIA-1096 STANDARD.
- 6- TERMINATED PLUG HEIGHT: .237 [6.02] ±.005 [0.13] ON CABLE

| | | |
|---------|--------------------------------|--------------------|
| BULK | 50 MICRO-INCHES [1.27um] | 937-SP-360808-A161 |
| PACKAGE | CONTACT PLATING IN MATING AREA | PART NUMBER |

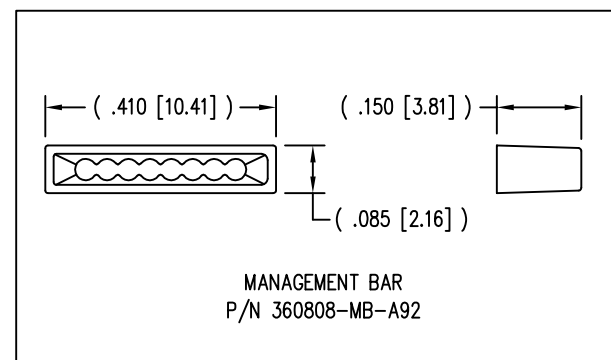
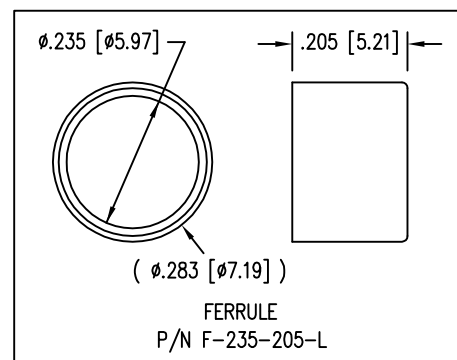

THIRD ANGLE PROJECTION

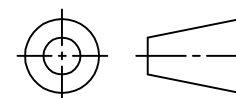

1118 Susquehanna Trail South
Glen Rock, PA 17327-9199
(717) 235-7512

<http://www.stewartconnector.com>

DO NOT SCALE DRAWING
DRAWING IS SUBJECT TO
CHANGE WITHOUT NOTICE

TITLE: 8 POSITION/8 CONDUCTOR STANDARD SHIELDED PLUG ASSEMBLY

DIMENSIONS: INCHES [METRIC]
UNLESS OTHERWISE SPECIFIED
TOLERANCES ARE ±.005 [0.13]
ANGLES ARE ± 1°

THIS DRAWING AND THE SUBJECT MATTER SHOWN THEREON ARE CONFIDENTIAL AND THE PROPRIETARY PROPERTY OF STEWART CONNECTOR AND SHALL NOT BE REPRODUCED, COPIED, OR USED IN ANY MANNER WITHOUT PRIOR WRITTEN CONSENT OF STEWART CONNECTOR. ONE OR MORE U.S. PATENTS MAY APPLY TO THIS PRODUCT. FOR DETAILS, PLEASE VISIT: [HTTP://BELFUSE.COM/STEWART/STEWART_PATENTS/](http://BELFUSE.COM/STEWART/STEWART_PATENTS/)

| | | | |
|----------|----------|------|---------|
| DRN BY: | TRM | DATE | 1-23-03 |
| APPD BY: | RGC | DATE | 1-24-03 |
| DWG NO. | CT360101 | REV. | A8 |

SHEET NO. 1 OF 1

