



Quartz Crystal Specification

IQD Part No. + Packaging: LFX TAL081316Reel

Würth Part No. 830108131601



Description

- Quartz crystal in a ceramic package with a electro beam sealed metal lid.
- Model IQXC-240
- Model Issue number 4

Frequency Parameters

- Frequency 38.40MHz
- Frequency Tolerance ± 7.00 ppm
- Frequency Stability ± 15.00 ppm
- Operating Temperature Range -30.00 to 85.00 °C
- Overtone Order Fundamental

Electrical Parameters

- Load Capacitance (CL) 5.00pF
- Shunt Capacitance (C0) 5pF max
- Drive Level 100 μ W max
- ESR 60.00 Ω max

Environmental Parameters

- Storage Temperature Range: -55 to 125 °C

Compliance

- RoHS Status (2015/863/EU) Compliant
- REACH Status Compliant
- MSL Rating (JDEC-STD-033): Not Applicable

Packaging Details

- Pack Style: Reel Tape & reel in accordance with EIA-481D
Pack Size: 5,000
- *Alternative packing option available*

USEFUL LINKS

Toolbox:

www.we-online.com/toolbox

Product Catalog:

www.we-online.com/products

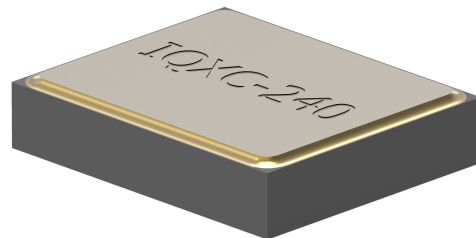

Outline (mm)

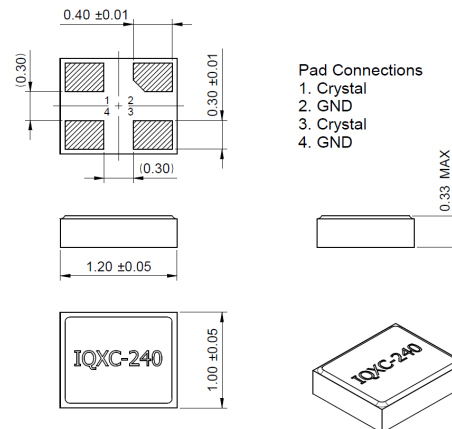

Recommended Solder Pad Layout

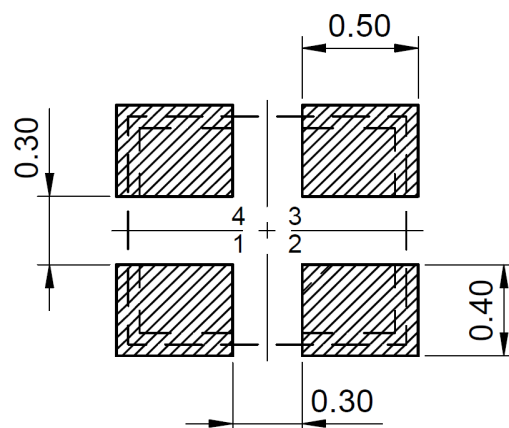

CONTACT INFORMATION:

Würth Elektronik eiSos GmbH & Co. KG
Max-Eyth-Str. 1, 74638 Waldenburg, Germany
Tel: +49(0) 7942 945-0

Email: eiSos@we-online.de
Web: www.we-online.com