

Single Turn Trimmer

Model 72



Features:

- 3/8" square
- Single turn
- Cermet

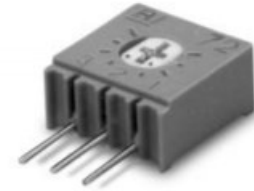

Electrical

Standard Resistance Range, Ohms	10 to 2Meg
Standard Resistance Tolerance	±10% (<100 Ohms = ±20%)
Input Voltage, Maximum	200 Vdc or rms not to exceed power rating
Slider Current, Maximum	100mA or within rated power, whichever is less
Power Rating, Watts	0.5 at 85°C derating to 0 at 125°C
End Resistance, Maximum	2 Ohms
Actual Electrical Travel, Nominal	244°
Dielectric Strength	900 Vrms
Insulation Resistance, Minimum	1,000 Megohms
Resolution	Essentially infinite
Contact Resistance Variation, Maximum	1% or 1 Ohm, whichever is greater

Environmental

Seal	85°C Fluorinert® (No Leaks)
Temperature Coefficient, Maximum	±100ppm/°C
Operating Temperature Range	-55°C to +125°C
Thermal Shock	5 cycles, -55°C to +125°C (1% ΔRT, 1% ΔVR)
Moisture Resistance	Ten 24 hour cycles (1% ΔRT, IR 100 Megohms Min.)
Shock, 6ms Sawtooth	100G's (1% ΔRT, 1% ΔVR)
Vibration	20G's, 10 to 2,000 Hz (1% ΔRT, 1% ΔVR)
High Temperature Exposure	250 hours at 125°C (2% ΔRT, 2% ΔVR)
Rotational Life	200 cycles (3% ΔRT)
Load Life at 0.5 Watts	1,000 hours at 70°C (2% ΔRT)
Resistance to Solder Heat	260°C for 10 sec. (1% ΔRT)

Mechanical

Mechanical Stops	Solid
Torque, Starting Maximum	3 oz.-in. (0.021 N-m)
Weight, Nominal	.027 oz. (0.77 grams)

General Note
TT Electronics reserves the right to make changes in product specification without notice or liability. All information is subject to TT Electronics' own data and is considered accurate at time of going to print.

TT Electronics | BI Technologies
Circulo de la Amistad #102 PIMSA IV Mexicali B.C. Mexico C.P 21210
Ph: + 1 (714) 447-2345
www.ttelectronics.com/bi-technologies

Packaging Information

Standard: Boxes
Capacity = 100 Units

Option: Tubes
All units oriented with #1 pin to same side.

	Pin Style	P, PM	X, XL, XW, RW
Magazine	Width	= 0.47"	0.29"
	Height	= 0.54"	0.76"
	Length	= 20.5"	20.1"
	Capacity	= 50 Units	50 Units

Option: Tape & Reel, Ammo Pack (Available only for 72RW only)
All units oriented with #1 pin to the right of the direction of feed.

	Seat Plane to Centerline of Sprocket Hole	
Tape	Width	= .71" (18.03 mm)
	Sprocket	= Single Hole .50" spacing
	Capacity	= 1,000 Units
	Reel Diameter	= 14" (356mm)
Ammo	Tape Fold	= 12" (305mm)
Box		= 1.8" x 13" x 10" (46mm x 330mm x 254mm)

EXTENDED ROTOR OPTION (Inch/mm)

Available for all Model 72 pin styles:
72PE, 72PLE, 72PME, 72PXE, 72RPXE, 72XE, 72RXE, 72XLE, 72RXLE, 72RWE, 72XWE, 72RXWE

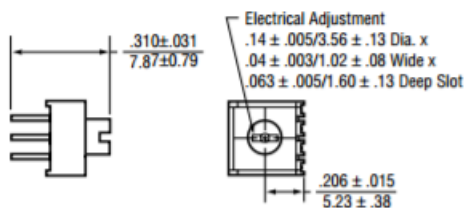

ADJUSTMENT KNOB OPTION (Inch/mm)

Available options:
72XT- Side Adjustment (See 72X for Pin Configuration)
72PT- Top Adjustment (See 72P for Pin Configuration)

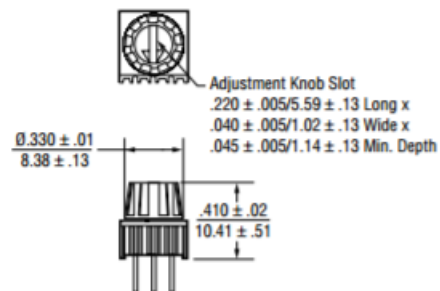

72PT Shown - Dimensions applicable to 72XT

Outline Drawings—Top Adjustment

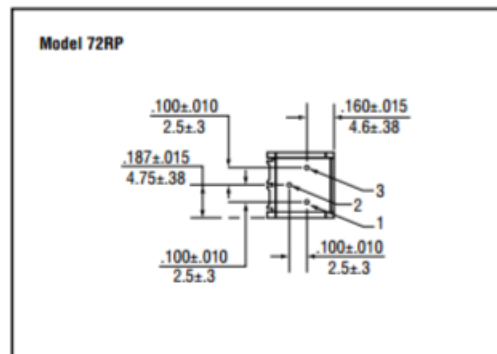
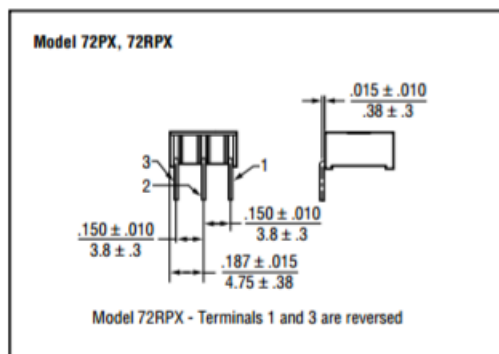
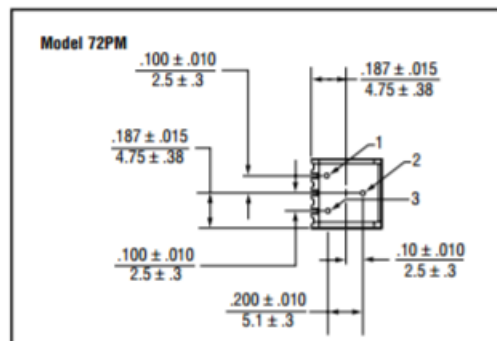
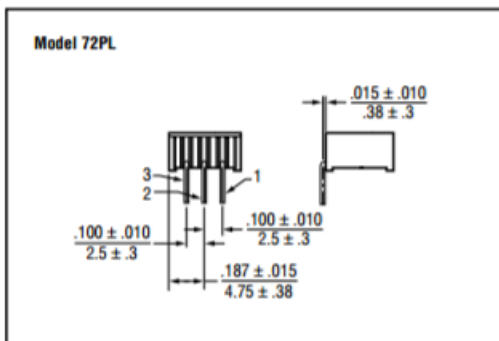
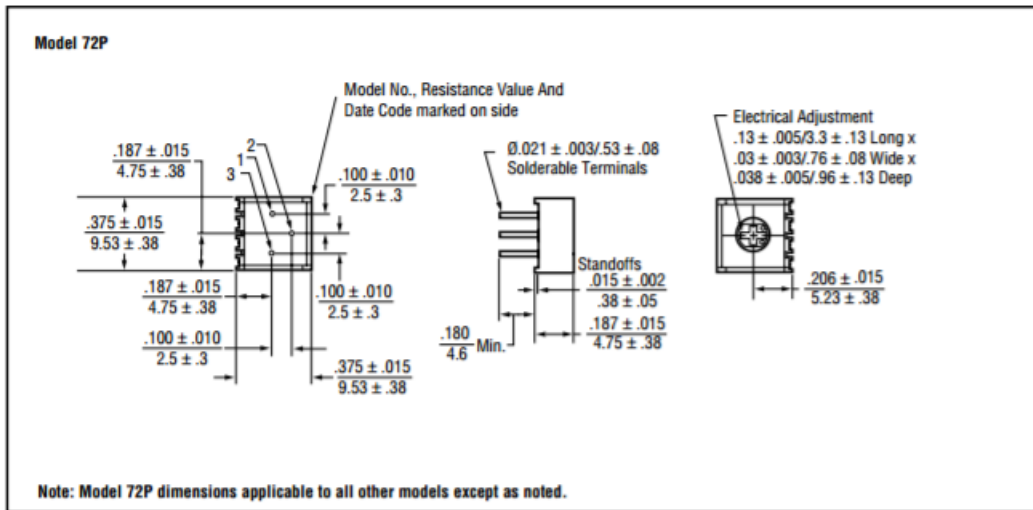

Outline Drawings—Side Adjustment

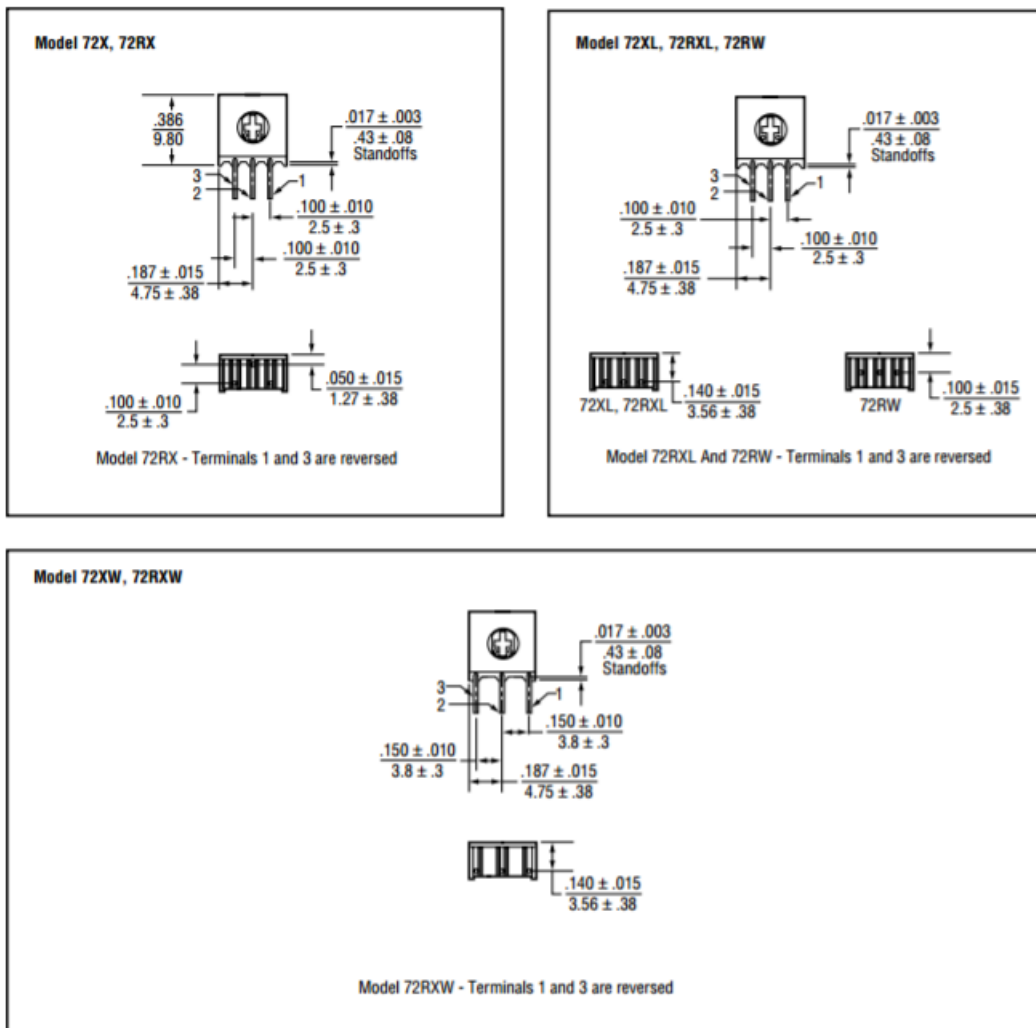

General Note
 TT Electronics reserves the right to make changes in product specification without notice or liability. All information is subject to TT Electronics' own data and is considered accurate at time of going to print.

TT Electronics | BI Technologies
 Circulo de la Amistad #102 PIMSA IV Mexicali B.C. Mexico C.P 21210
 Ph: + 1 (714) 447-2345
www.ttelectronics.com/bi-technologies

Single Turn Trimmer

Model 72



Ordering Information

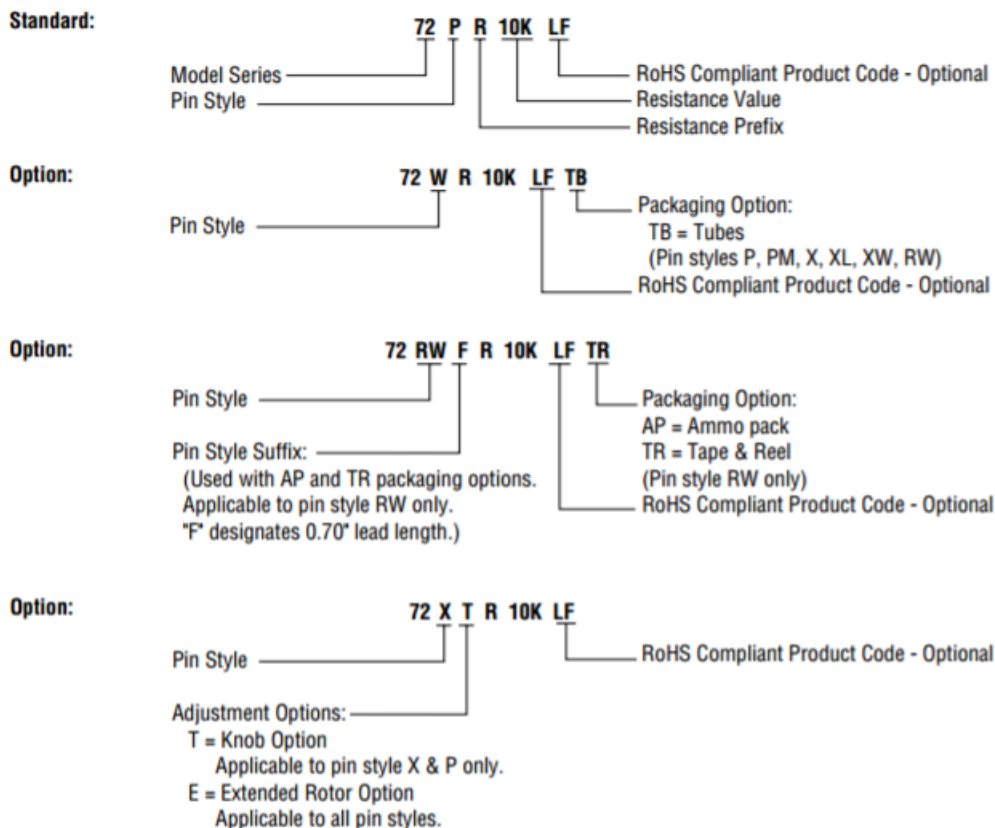

Standard Resistance Values, Ohms

10	100	1K	10K	50K	250K
20	200	2K	20K	100K	500K
50	500	5K	25K	200K	1Meg

Circuit Diagram

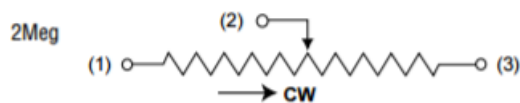

NOTES

Metric equivalents, based on 1 inch = 25.4mm are rounded to the same number of significant figures as in the original English units and are provided for general information only.

Tolerances unless otherwise specified:
 Linear = ± .01 inches (.25mm)
 Angular = ± 2 degrees

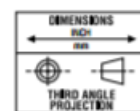

General Note
 TT Electronics reserves the right to make changes in product specification without notice or liability. All information is subject to TT Electronics' own data and is considered accurate at time of going to print.

TT Electronics | BI Technologies
 Circulo de la Amistad #102 PIMSA IV Mexicali B.C. Mexico C.P 21210
 Ph: + 1 (714) 447-2345
 www.ttelectronics.com/bi-technologies