



# 承认书

## SPECIFICATION FOR APPROVAL

客户名称：

Customer

品 名： 色码电感器

Part name Axial color code inductor

规 格： LGA0410- XXX X X XX E

Product SPEC \_\_\_\_\_

版 本 号： V1.4

Version

日 期： 2020/08/11

Date

客户 Customer			制造 Manufacturer		
确认 Approval			确认 Approval		
检验 Inspector	审核 Checker	批准 Approver	拟制 Designer	审核 Checker	批准 Approver
			夏少平	贺义勇	张惠霞



### 1、订货代码 HOW TO ORDER

举例 For example

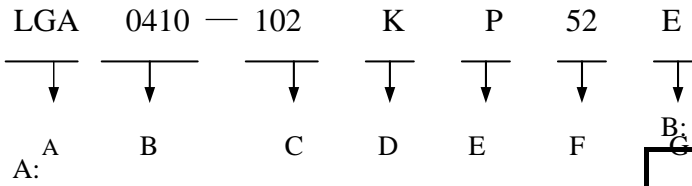

A:

产品类别 Product type
LGA          轴向色码电感器 Axial color code inductor

B:  
C

尺寸 Dimensions (mm)		
类型 Type	外径 $D_{max}$	体长 $L_{max}$
0410	4.0	10.5

C:

标称电感量 Inductance ( $\mu H$ )
<p>前两位数字为有效数字, 后一位数字表示零的个数。 The first two digits are significant, and the third digit is number of zeros. *例如 For example: 100=10 <math>\mu H</math> 101=100 <math>\mu H</math> 5R6=5.6 <math>\mu H</math> R22=0.22 <math>\mu H</math></p>

D:

感量偏差 Tolerance	
J	$\pm 5.0\%$
K	$\pm 10\%$
M	$\pm 20\%$

E:

包装方式 Packaging style		
编带 Tape & reel	P	盒带包装 Ammo
	T	卷带包装 Reel
散包装 Bulk	F	直脚轴向 Axial
	L	直脚成型 Straight lead formed
	V	弯脚成型 Bent lead formed
	VK	弯脚 K 型 Bent lead K formed

F:

引脚形式 Lead configuration		
编带 Tape & reel	26	编带内距: 26mm Tape width:
	52	编带内距: 52mm Tape width:
引脚成型 Formed lead	05	引脚脚距: 5.08mm Formed lead pitch:
	07	引脚脚距: 7.5mm Formed lead pitch:
	10	引脚脚距: 10.0mm Formed lead pitch:
	12	引脚脚距: 12.5mm Formed lead pitch:
	15	引脚脚距: 15.0mm Formed lead pitch:
	17	引脚脚距: 17.5mm Formed lead pitch:
	20	引脚脚距: 20.0mm Formed lead pitch:

G:

备注 Remark	
E	无铅 Lead Free
空格 Blank	含铅 Lead Contained

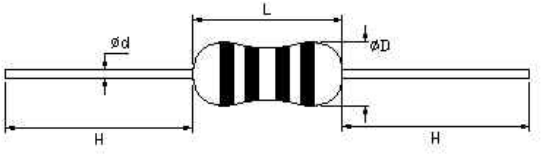
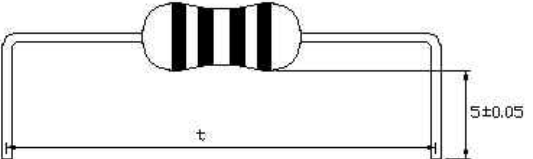
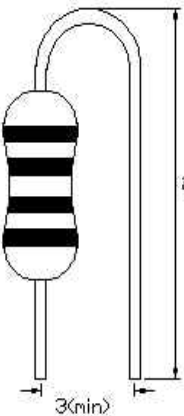
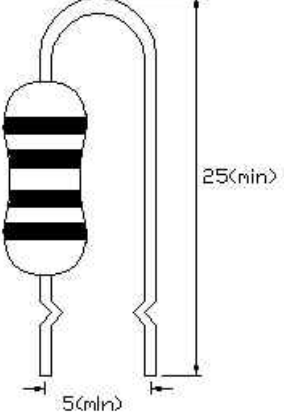

2、外形尺寸 EXTERNAL DIMENSIONS

类型 Type	尺寸 Body size (mm)					 轴向 (Axial)
	$\phi D \leq$	$L \leq$	$t = t_0 \pm 0.6$	$\phi d$	$H \geq$	
LGA0410	4.0	10.5	$t_0 = 15.0;$ $17.5;$ $20.0$	$0.60$ $\pm 0.05$	20	 直脚成型 (L type)
						 弯脚成型 (V type)
						 弯脚 K 型 (VK type)



### 3、色码标记代号 MARKING

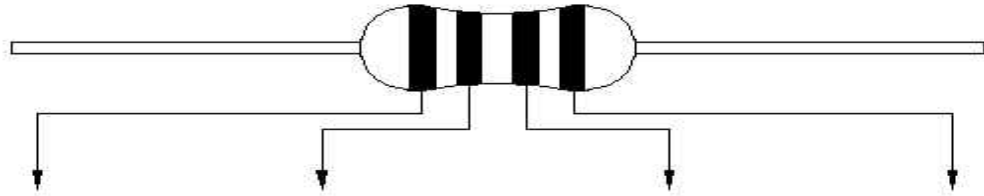

	标称电感量 Nominal inductance ( $\mu$ H )			感量偏差 Tolerance
	第一色环 1 <sup>st</sup> color zone	第二色环 2 <sup>nd</sup> color zone	第三色环 3 <sup>rd</sup> color zone	第四色环 4 <sup>th</sup> color zone
	第一数字 1 <sup>st</sup> digit	第二数字 2 <sup>nd</sup> digit	第三数字 3 <sup>rd</sup> digit	
黑 Black	0	0	$\times 10^0$ (1)	M: $\pm 20\%$
棕 Brown	1	1	$\times 10^1$ (10)	
红 Red	2	2	$\times 10^2$ (100)	
橙 Orange	3	3	$\times 10^3$ (1000)	
黄 Yellow	4	4	$\times 10^4$ (10000)	
绿 Green	5	5	$\times 10^5$ (100000)	
蓝 Blue	6	6		
紫 Purple	7	7		
灰 Gray	8	8		
白 White	9	9		
金 Gold	/	/	$\times 10^{-1}$ (0.1)	J: $\pm 5\%$
银 Silver	/	/	$\times 10^{-2}$ (0.01)	K: $\pm 10\%$

\*例如 e.g. :

标称电感量及偏差为 22 $\mu$ H,  $\pm 5\%$ 的电感器其色码为: 红+红+黑+金;

If nominal inductance & tolerance is 22 $\mu$ H,  $\pm 5\%$ , respectively red+red+black+gold should be marked;

标称电感量及偏差为 1.0 $\mu$ H,  $\pm 10\%$ 的电感器其色码为: 棕+黑+金+银;

If nominal inductance & tolerance is 1.0 $\mu$ H,  $\pm 10\%$ , respectively brown+black+gold+silver should be marked;

标称电感量及偏差为 0.22 $\mu$ H,  $\pm 20\%$ 的电感器其色码为: 红+红+银+黑。

If nominal inductance & tolerance is 0.22 $\mu$ H,  $\pm 20\%$ , respectively red+red+silver+black should be marked.

### 4. 电性能参数及测试条件 ELECTRICAL CHARACTERISTICS & TEST CONDITIONS

#### LGA0410 型电感器电性能参数及测试条件



LGA0410 TYPE INDUCTORS ELECTRICAL CHARACTERISTICS & TEST CONDITIONS

LGA0410 类型 Type	电感量 Inductance ( $\mu$ H)	误差 Tolerance	Q (min)	直流电阻 RDC ( $\Omega$ ) max	测试频率 Test frequency (MHz)	自谐频率 SRF (MHz) min	额定电流 Rated current I <sub>bc</sub> (mA) max
LGA0410-R22	0.22	M: ±20%	45	0.10	25.2	300	1400
LGA0410-R27	0.27		45	0.11		270	1320
LGA0410-R33	0.33		45	0.12		250	1280
LGA0410-R39	0.39		45	0.13		230	1200
LGA0410-R47	0.47		45	0.14		220	1150
LGA0410-R56	0.56		45	0.15		200	1122
LGA0410-R68	0.68		45	0.16		190	1030
LGA0410-R82	0.82		45	0.17		172	980
LGA0410-1R0	1.0		45	0.19		157	920
LGA0410-1R2	1.2		50	0.21		144	880
LGA0410-1R5	1.5	50	0.23	131	830		
LGA0410-1R8	1.8	55	0.25	121	790		
LGA0410-2R2	2.2	55	0.28	110	750		
LGA0410-2R7	2.7	60	0.30	100	720		
LGA0410-3R3	3.3	65	0.34	94	670		
LGA0410-3R9	3.9	65	0.37	65	640		
LGA0410-4R7	4.7	70	0.39	56	620		
LGA0410-5R6	5.6	70	0.43	48	590		
LGA0410-6R8	6.8	75	0.48	37	550		
LGA0410-8R2	8.2	80	0.52	25	530		
LGA0410-100	10	65	0.58	21	500		
LGA0410-120	12	50	0.63	19	480		
LGA0410-150	15	50	0.72	17	460		
LGA0410-180	18	50	0.77	13	430		
LGA0410-220	22	50	0.84	9.6	410		
LGA0410-270	27	55	0.94	7.2	390		
LGA0410-330	33	55	1.03	6.3	370		
LGA0410-390	39	50	1.12	6.3	350		
LGA0410-470	47	45	1.22	6.3	340		
LGA0410-560	56	40	1.34	6.2	320		
LGA0410-680	68	40	1.47	5.7	305		
LGA0410-820	82	35	1.62	5.3	290		
LGA0410-101	100	30	1.80	4.8	275		
LGA0410-121	120	55	3.70	3.8	185		
LGA0410-151	150	45	4.20	3.5	175		
LGA0410-181	180	50	4.60	3.3	165		
LGA0410-221	220	55	5.10	3.0	155		
LGA0410-271	270	65	5.80	2.8	145		
LGA0410-331	330	65	6.40	2.6	137		
LGA0410-391	390	65	7.00	2.4	133		
LGA0410-471	470	60	7.70	2.25	126		
LGA0410-561	560	60	8.50	2.10	120		
LGA0410-681	680	55	9.40	1.95	113		
LGA0410-821	820	55	10.50	1.85	105		
LGA0410-102	1000	50	14.00	1.40	100		
LGA0410-152	1500	45	30.0	0.90	80		
LGA0410-182	1800	40	30.0	0.85	85		
LGA0410-202	2000	40	30.0	0.82	82		
LGA0410-222	2200	40	34.7	0.80	80		
LGA0410-302	3000	40	50.0	0.75	75		
LGA0410-332	3300	40	59.6	0.70	62		
LGA0410-472	4700	40	74.0	0.60	55		
测试仪器 Test equipment	HP4285A (HP4286A, HP4287A)			HP4338B		HM9461	HP42841A
环境温度 Ambient temperature	18~25℃						
环境湿度 Ambient humidity	45%~75%						

# 特殊要求的产品可以根据客户要求生产



The products can be customized according to customer requirement.

**5、可靠性试验项目及要求： ITEM AND REQUIREMENT OF RELIABILITY TEST**

项目 Item	性能要求 Specification	试验条件及方法 Test methods and remarks
1 工作温度范围 Operating temperature range	-25~+105℃	
2 储存温度范围 Storage temperature range	+5~+35℃	
3 外观和外形尺寸 Appearance & dimensions	符合产品规范和公差要求 Conformity to the product specification	目测，精度不低于 0.02 mm 的游标卡尺测量 Eyeball; vernier calliper with precision no lower than 0.02mm
4 L 值、Q 值 Inductance、Q	在规定的允许范围内 Within the specified tolerance	电感量和 Q 值在规定的测试频率下，用 HP4285A 进行测试。 Condition: at specified test frequency. Test equipment: HP4285A
5 直流电阻 DC resistance	在规定的允许范围内 Within the specified tolerance	测试仪器：HP4338B Test equipment: HP4338B
6 自谐振频率 Self-resonance frequency	在规定的允许范围内 Within the specified tolerance	测试仪器：射频/阻抗材料分析仪 HP4291A Test equipment: HP4291A
7 额定电流 Rated current	在规定的允许范围内 Within the specified tolerance	电感值变化 10%、温升 20℃ 以内的最大直流电流。 The maximum DC value having inductance within 10% and temperature increase within 20℃ by the application of DC bias.
8 引出端强度 Terminal strength	外观无可见损伤、引线不断 There shall be no evidence of damage during the test and the lead no breakage.	拉力：沿轴向施加 2.5kgf，持续时间：10s Pull: adding 2.5kgf down axial Duration: 10s 弯折循环：在靠近端子末端将引线弯折 90 度后还原持续 5s，再向反方向重复一次为一个循环。重复 2 次 Bucking cycle: buck lead 90° at the end of closing terminal and then reset keeping 5s, redoing one time at the counter is one cycle. Repeat two times.
9 耐焊接热 Resistance to soldering heat	$\Delta L/L \leq \pm 5\%$ $\Delta Q/Q \leq \pm 20\%$	焊锡温度：270±5℃ 浸锡时间：10±1s 恢复时间：1~2 小时 Tin review: 270±5℃ Duration: 10±1s Recovery: 1~2hours
10 可焊性 Solder ability	引线的表面圆周覆盖率不小于 95% Leads shall be at least 95% areas covered with a new solder coating.	焊锡温度：250±5℃ 浸锡时间：2±0.5s Tin review: 250±5℃ Duration: 2±0.5s
11 标记耐溶剂性 Resistance to solvent	标志无可见损伤 There shall be no evidence of damage	溶剂温度：25±5℃ Solvent temperature: 25±5℃ 将棉球和样品浸在溶剂中 1min，在样品有标志部位用棉球擦 3 次。 There shall be put the cotton ball and sample steep in dissolvent 1min, at sample's notation area brush 10 times, repeat 3 times
12 介质耐压 Dielectric Withstanding Voltage	无弧光、击穿或损伤。 There shall be no arc, breakdown or damage.	在外封和引线间施加直流电压 500V，持续 60 秒。 Apply 500VDC between outer coating and terminal for 60sec.
13 绝缘电阻 Insulation resistance	$IR \geq 100M\Omega$	在外封装和引线间施加直流电压 500V，持续 60 秒。 Apply 500VDC between outer coating and terminal for 60sec.
14 温度特性 Temperature characteristic	$\Delta L/L \leq \pm 5\%$ $\Delta Q/Q \leq \pm 20\%$	以 20℃ 电感量为基准，在 -25℃—+85℃ 测量电感量 Measurement shall be made at an ambient temp of -25℃—+85℃ reference inductance shall be measured at 20℃.
15 高温试验 High temperature life test	$\Delta L/L \leq \pm 10\%$ $\Delta Q/Q \leq \pm 30\%$	温度：85±2℃，试验时间：96 小时 Test temperature: 85±2℃, Time: 96hours

备注：1、如无特别指定时，电性能测试应在常温、常湿中恢复 1~2 小时，然后立即测试。

2、若测试结果有争议时，仲裁试验结果用标准大气条件为：温度：25±1℃，相对湿度 48%~52%，气压：86~106kPa。

Note: 1. In the event of no special requirement, the measurement shall be conducted immediately after a recovery of 1~2 hours under the standard condition.

2. In the event of any dispute, the standard condition for arbitration shall be as follows: 25±1℃ of temperature, 48%~52% RH and 86~106kPa air pressure.



6、包装方式 PACKAGING STYLE

● 编带尺寸 Taping dimensions

单位 UNIT: mm

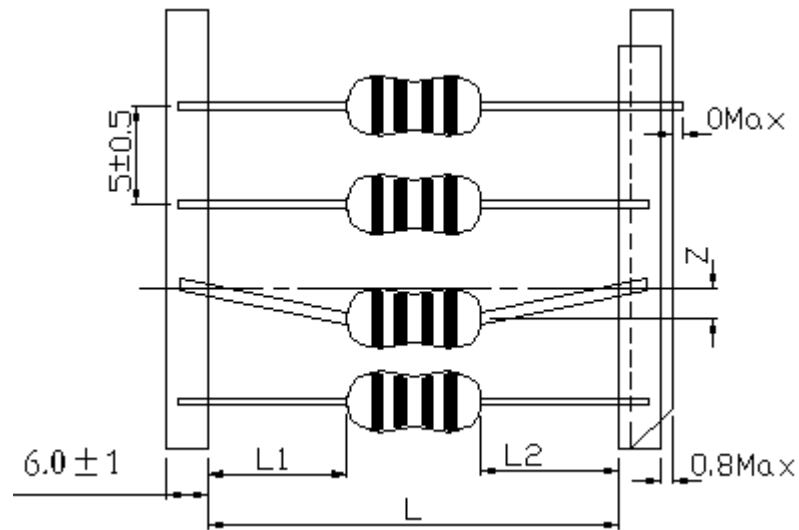

编带方式 Tape style	L	Z	L1-L2
编带内距:26 Tape width	$26 \pm 1.0$	0.8 Max	1.0 Max
编带内距:52 Tape width	$52 \begin{smallmatrix} +2.0 \\ -1.0 \end{smallmatrix}$	1.2 Max	

● 卷带包装尺寸 Tape & reel packaging dimensions

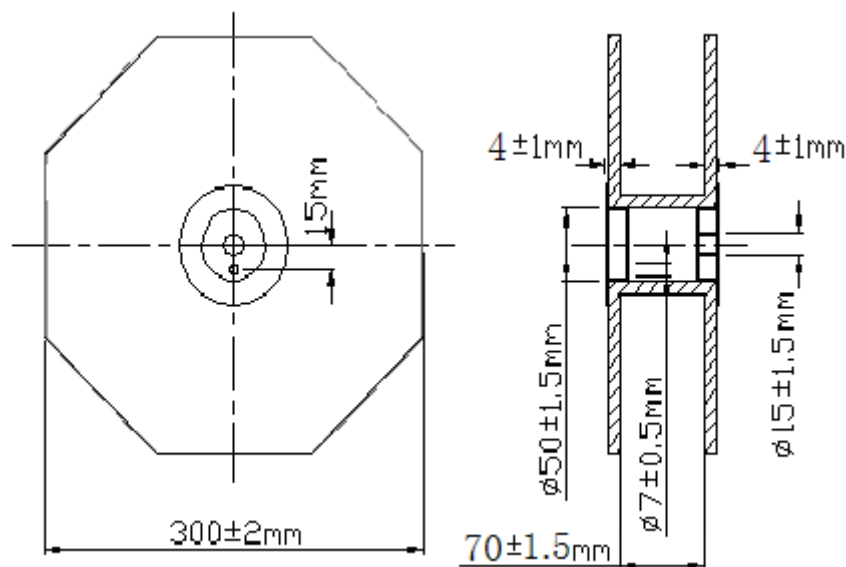

● 盒带包装尺寸 Ammo packaging dimensions

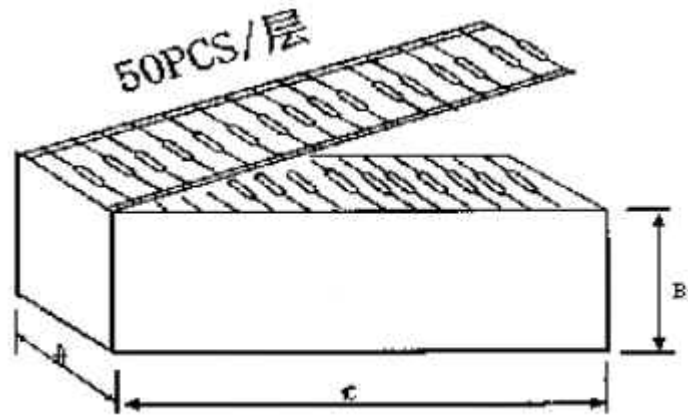

● 包装盒尺寸 Dimensions of box

单位 UNIT: mm

编带类型 Tape type	尺寸 Dimensions (±5mm)		
	A	B	C
52	75	90	256
26	50	110	256

● 包装数量 Packaging quantity

包装方式 Packaging style	盒带包装 Ammo	卷带包装 Tape & reel	散包装 Bulk
包装数量 Quantity	2000	3000	1000

# 可根据用户需求包装

Packaging according to customer's requirement