



TO-92L Plastic-Encapsulate Transistors

TPT5609 TRANSISTOR (NPN)

FEATURES

- Excellent Linearity of Current Gain
- Low saturation voltage
- Complementary to TPT5610

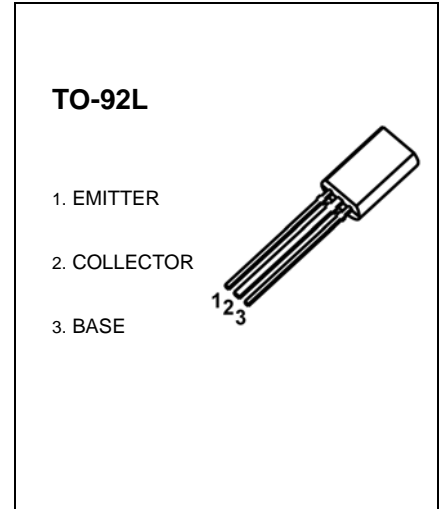

MARKING

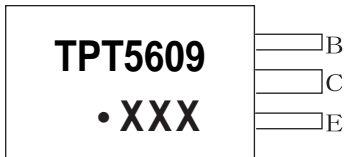

TPT5609=Device code
 Solid dot= Green molding compound device,
 if none, the normal device
 XXX=Code

Equivalent Circuit

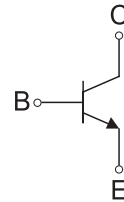

ORDERING INFORMATION

Part Number	Package	Packing Method	Pack Quantity
TPT5609	TO-92L	Bulk	500pcs/Bag
TPT5609-TA	TO-92L	Tape	2000pcs/Box

MAXIMUM RATINGS (T_a=25°C unless otherwise noted)

Symbol	Parameter	Value	Unit
V _{CB0}	Collector- Base Voltage	25	V
V _{CE0}	Collector-Emitter Voltage	20	V
V _{EB0}	Emitter-Base Voltage	5	V
I _C	Collector Current -Continuous	1	A
P _C	Collector Power Dissipation	0.75	W
T _J , T _{stg}	Operation Junction and Storage Temperature Range	-55-150	°C

ELECTRICAL CHARACTERISTICS

$T_a=25^\circ\text{C}$ unless otherwise specified

Parameter	Symbol	Test conditions	Min	Typ	Max	Unit
Collector-base breakdown voltage	$V_{(BR)CBO}$	$I_C=10\mu\text{A}, I_E=0$	25			V
Collector-emitter breakdown voltage	$V_{(BR)CEO}$	$I_C=1\text{mA}, I_B=0$	20			V
Emitter-base breakdown voltage	$V_{(BR)EBO}$	$I_E=10\mu\text{A}, I_C=0$	5			V
Collector cut-off current	I_{CBO}	$V_{CB}=20\text{V}, I_E=0$			1	μA
Emitter cut-off current	I_{EBO}	$V_{EB}=5\text{V}, I_C=0$			1	μA
DC current gain	h_{FE}	$V_{CE}=2\text{V}, I_C=500\text{mA}$	60		240	
Collector-emitter saturation voltage	$V_{CE(sat)}$	$I_C=800\text{mA}, I_B=80\text{mA}$			0.5	V
Base-emitter voltage	V_{BE}	$V_{CE}=2\text{V}, I_C=500\text{mA}$			1	V
Transition frequency	f_T	$V_{CE}=2\text{V}, I_C=500\text{mA}$		190		MHz
Collector output capacitance	C_{ob}	$V_{CB}=10\text{V}, I_E=0, f=1\text{MHz}$		22		pF

CLASSIFICATION OF h_{FE}

Rank	A	B	C
Range	60-120	85-170	120-240

Typical Characteristics

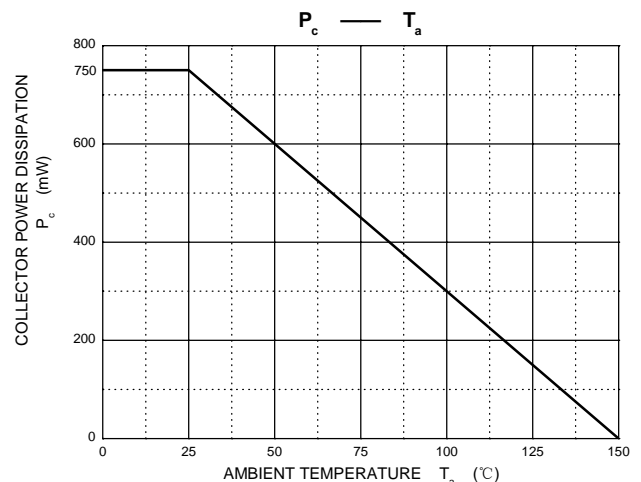
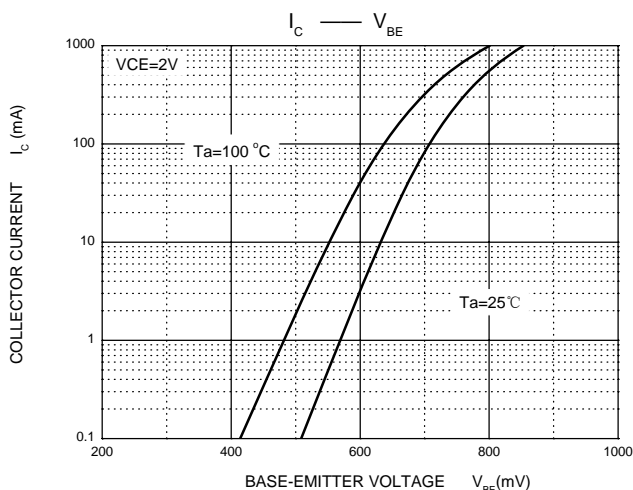
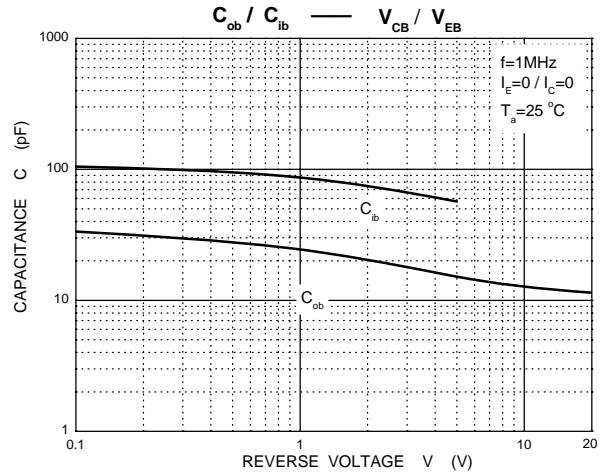
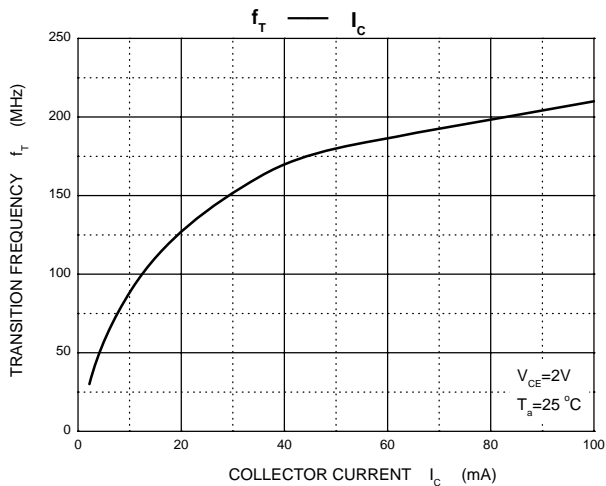
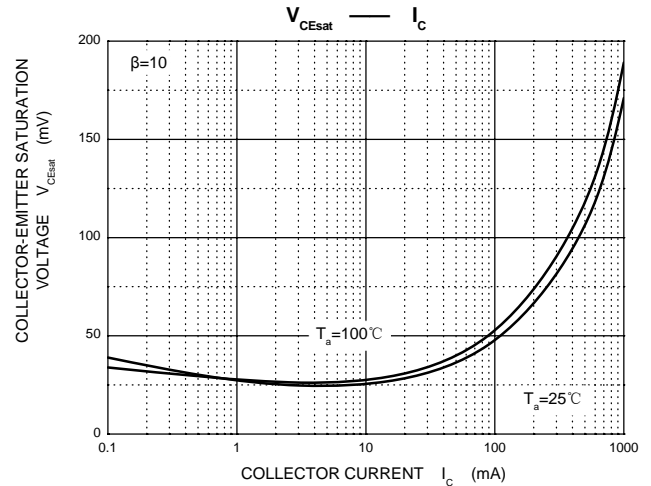
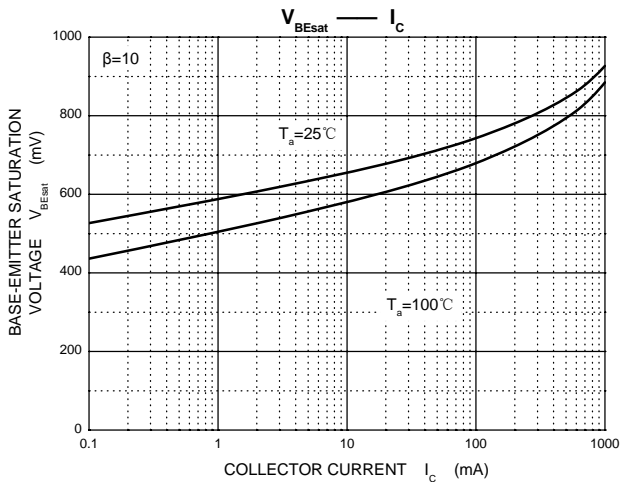
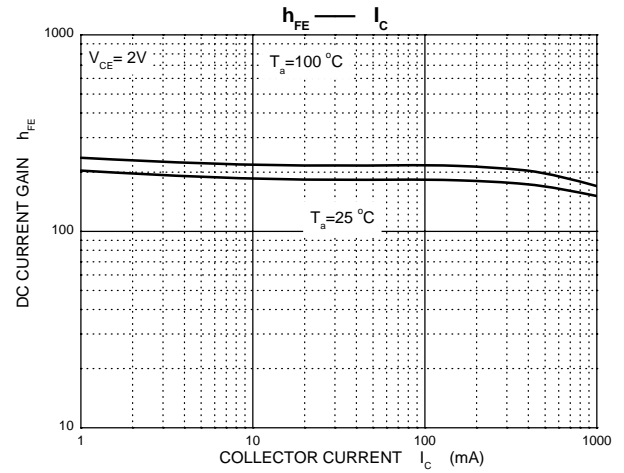
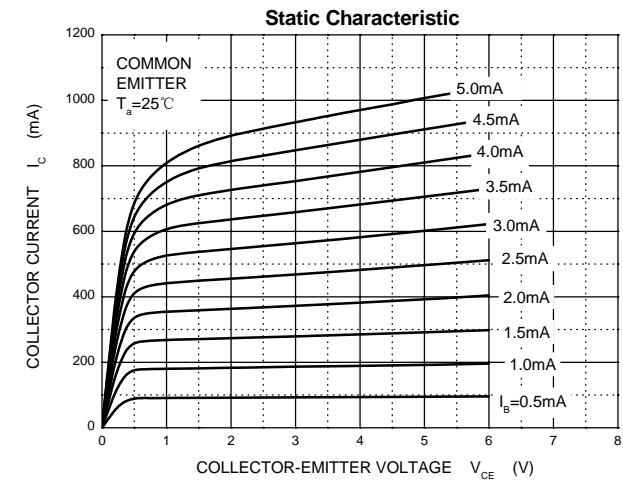

TO-92L Package Outline Dimensions

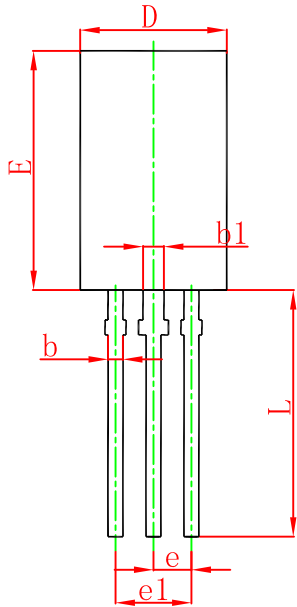
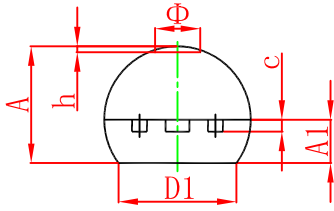

Symbol	Dimensions In Millimeters		Dimensions In Inches	
	Min.	Max.	Min.	Max.
A	3.750	4.050	0.148	0.159
A1	1.280	1.580	0.050	0.062
b	0.380	0.550	0.015	0.022
b1	0.620	0.780	0.024	0.031
c	0.350	0.450	0.014	0.018
D	4.750	5.050	0.187	0.199
D1	4.000		0.157	
E	7.850	8.150	0.309	0.321
e	1.270 TYP.		0.050 TYP.	
e1	2.440	2.640	0.096	0.104
L	13.800	14.200	0.543	0.559
Φ		1.600		0.063
h	0.000	0.300	0.000	0.012

TO-92L Suggested Pad Layout

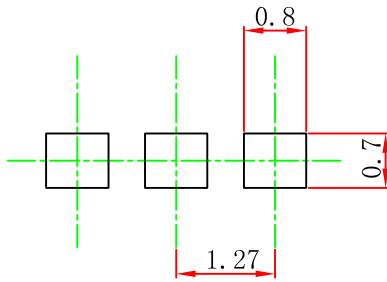

Note:

1. Controlling dimension: in millimeters.
2. General tolerance: ± 0.05 mm.
3. The pad layout is for reference purposes only.

NOTICE

JSCJ reserves the right to make modifications, enhancements, improvements, corrections or other changes without further notice to any product herein. JSCJ does not assume any liability arising out of the application or use of any product described herein.

TO-92L PACKAGE TAPING DIMENSION

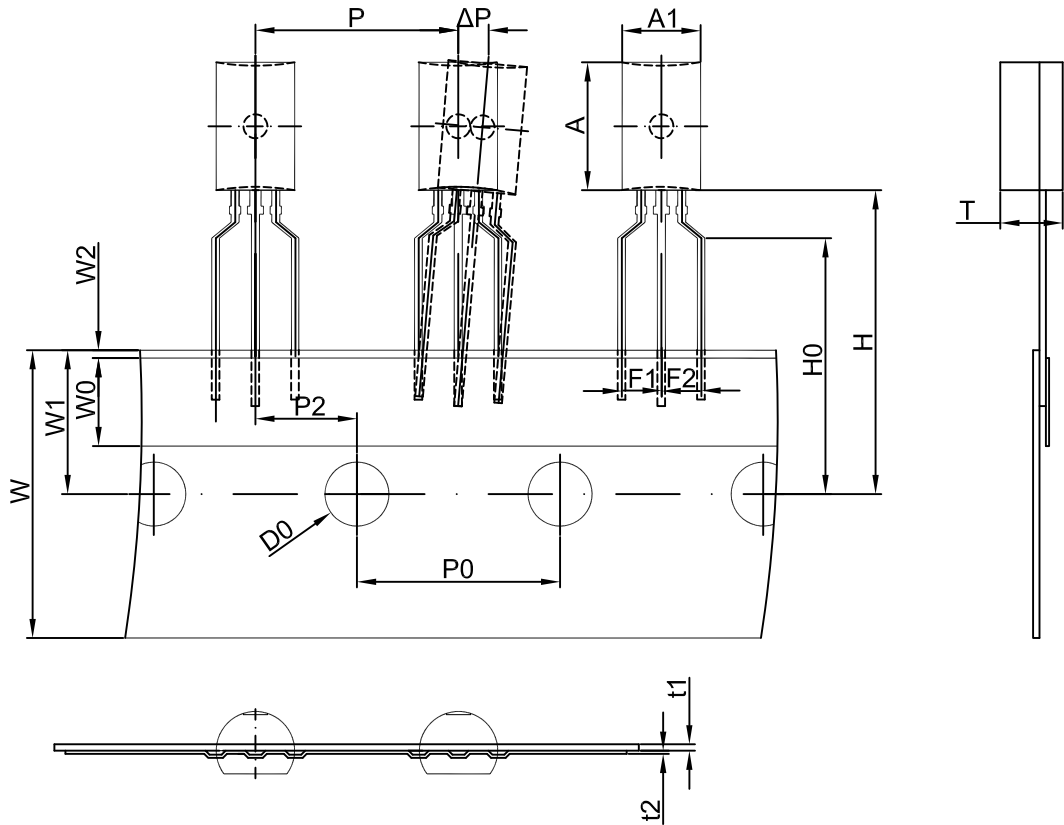

Dimensions are in millimeter

A1	A	T	P	P0	P2	F1	F2	W
4.9	8.0	3.9	12.7	12.7	6.35	2.5	2.5	18.0
W0	W1	W2	H	H0	D0	t1	t2	ΔP
6.0	9.0	1.0	19.0	16.0	4.0	0.4	0.2	0

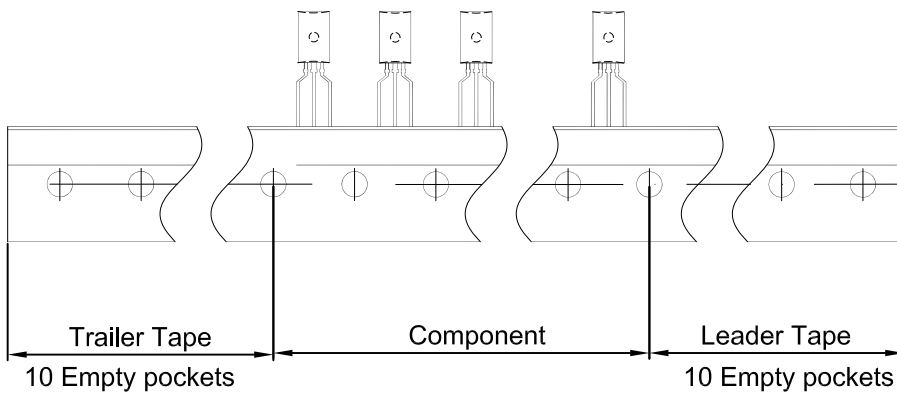

Package	Box	Box Size(mm)	Carton	Carton Size(mm)
TO-92L	2000 pcs	333×203×42	20,000 pcs	493×400×264