



FEATURES

- Collector current $I_C=1.5A$.
- Power amplifier applications.
- Complementary to SS8550W.



SOT-323

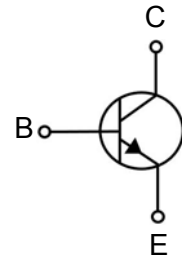

Package Marking and Ordering Information

Product ID	Pack	Marking	Qty(PCS)
SS8050W	SOT-323	Y1	3000

MAXIMUM RATINGS (Ta=25 unless otherwise noted)

Symbol	Parameter	Value	Unit
V_{CBO}	Collector-Base Voltage	40	V
V_{CEO}	Collector-Emitter Voltage	25	V
V_{EBO}	Emitter-Base Voltage	5	V
I_C	Collector Current	1.5	A
P_C	Collector Power Dissipation	250	mW
$R_{\theta JA}$	Thermal Resistance From Junction To Ambient	400	°C/W
T_J, T_{stg}	Operation Junction And Storage Temperature Range	-55~+150	°C

ELECTRICAL CHARACTERISTICS(Ta=25 unless otherwise noted)

Symbol	Parameter	Test conditions	Min	Typ	Max	Unit
$V_{(BR)CBO}$	Collector-base breakdown voltage	$I_C=100\mu A, I_E=0$	40			V
$V_{(BR)CEO}$	Collector-emitter breakdown voltage	$I_C=0.1mA, I_B=0$	25			V
$V_{(BR)EBO}$	Emitter-base breakdown voltage	$I_E=100\mu A, I_C=0$	5			V
I_{CEO}	Collector cut-off current	$V_{CE}=20V, I_E=0$			100	nA
I_{CBO}	Collector cut-off current	$V_{CB}=40V, I_E=0$			100	nA
I_{EBO}	Emitter cut-off current	$V_{EB}=5V, I_C=0$			100	nA
$h_{FE(1)}$	DC current gain(1)	$V_{CE}=1V, I_C=100mA$	120		400	
$h_{FE(2)}$	DC current gain(2)	$V_{CE}=1V, I_C=800mA$	40			
$V_{CE(sat)}$	Collector-emitter saturation voltage	$I_C=800mA, I_B=80mA$			0.5	V
$V_{BE(sat)}$	Base-emitter saturation voltage				1.2	V
f_T	Transition frequency	$V_{CE}=10V, I_C=50mA, f=300MHz$	100			MHz
C_{ob}	Collector output capacitance	$V_{CB}=10V, I_E=0, f=1MHz$			15	pF



Typical Characteristics

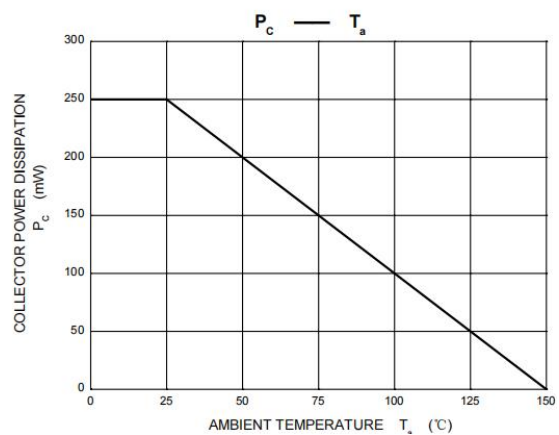
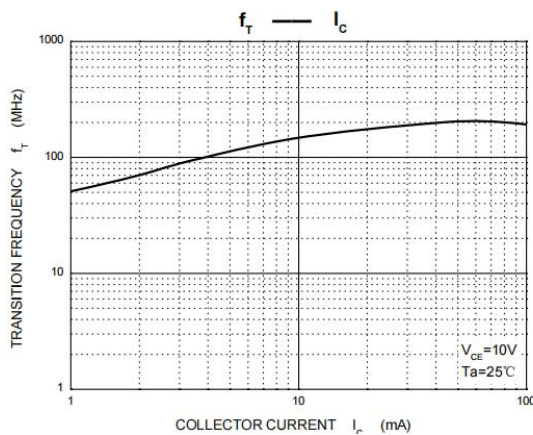
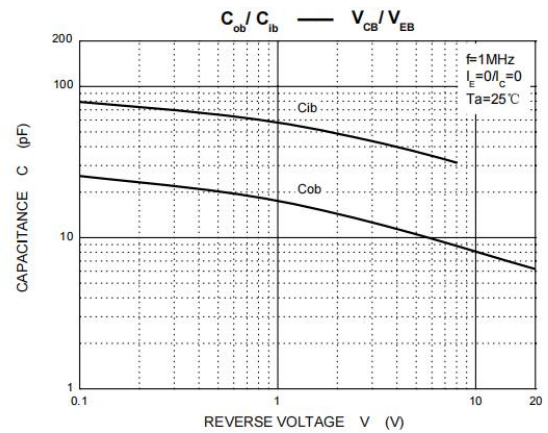
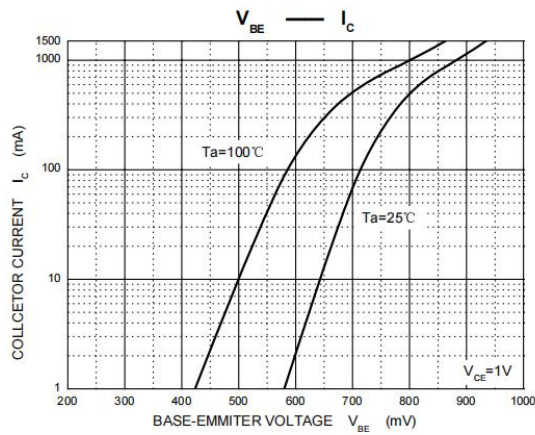
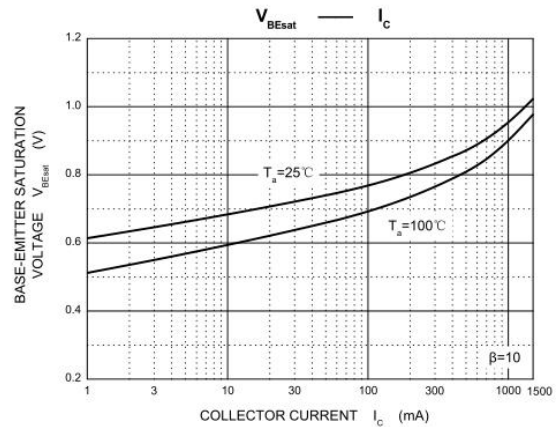
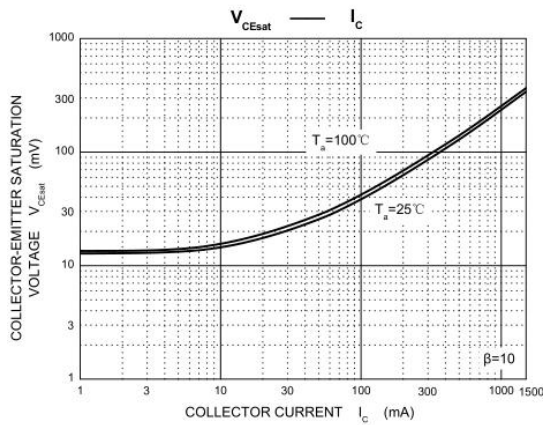
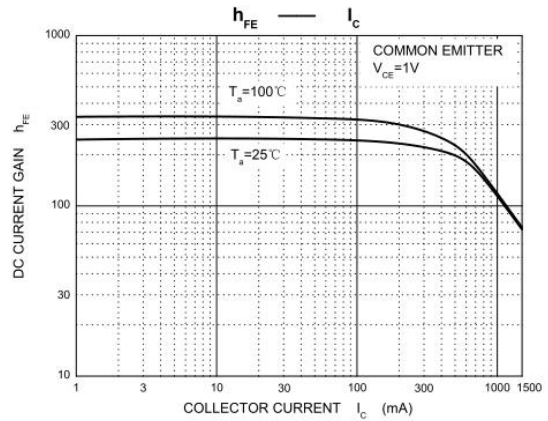
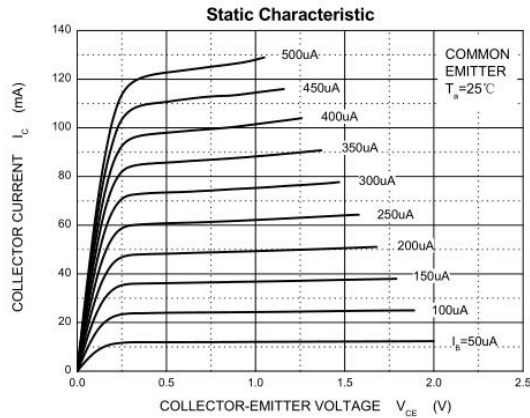



SOT-323 Package Outline Dimensions

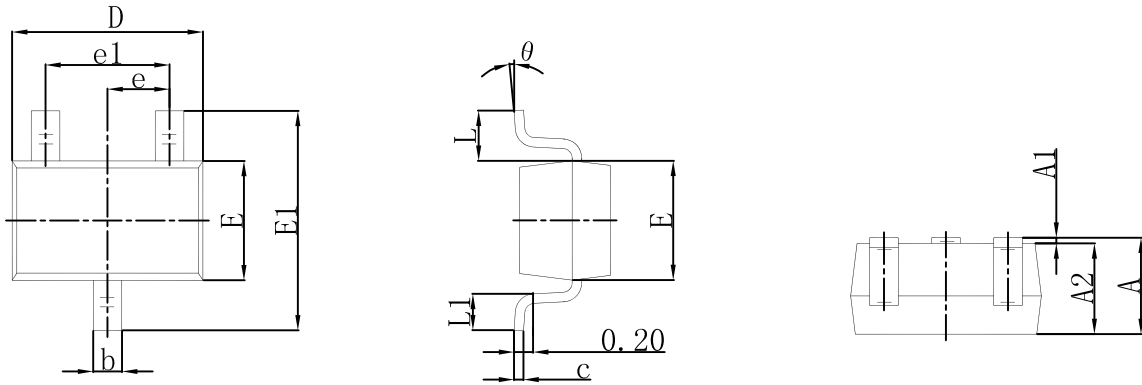

Symbol	Dimensions In Millimeters		Dimensions In Inches	
	Min	Max	Min	Max
A	0.900	1.100	0.035	0.043
A1	0.000	0.100	0.000	0.004
A2	0.900	1.000	0.035	0.039
b	0.200	0.400	0.008	0.016
c	0.080	0.150	0.003	0.006
D	2.000	2.200	0.079	0.087
E	1.150	1.350	0.045	0.053
E1	2.150	2.450	0.085	0.096
e	0.650 TYP		0.026 TYP	
e1	1.200	1.400	0.047	0.055
L	0.525 REF		0.021 REF	
L1	0.260	0.460	0.010	0.018
K	0°	8°	0°	8°



Attention

- Any and all HUA XUAN YANG ELECTRONICS products described or contained herein do not have specifications that can handle applications that require extremely high levels of reliability, such as life-support systems, aircraft's control systems, or other applications whose failure can be reasonably expected to result in serious physical and/or material damage. Consult with your HUA XUAN YANG ELECTRONICS representative nearest you before using any HUA XUAN YANG ELECTRONICS products described or contained herein in such applications.
- HUA XUAN YANG ELECTRONICS assumes no responsibility for equipment failures that result from using products at values that exceed, even momentarily, rated values (such as maximum ratings, operating condition ranges, or other parameters) listed in products specifications of any and all HUA XUAN YANG ELECTRONICS products described or contained herein.
- Specifications of any and all HUA XUAN YANG ELECTRONICS products described or contained herein stipulate the performance, characteristics, and functions of the described products in the independent state, and are not guarantees of the performance, characteristics, and functions of the described products as mounted in the customer's products or equipment. To verify symptoms and states that cannot be evaluated in an independent device, the customer should always evaluate and test devices mounted in the customer's products or equipment.
- HUA XUAN YANG ELECTRONICS CO.,LTD. strives to supply high-quality high-reliability products. However, any and all semiconductor products fail with some probability. It is possible that these probabilistic failures could give rise to accidents or events that could endanger human lives, that could give rise to smoke or fire, or that could cause damage to other property. When designing equipment, adopt safety measures so that these kinds of accidents or events cannot occur. Such measures include but are not limited to protective circuits and error prevention circuits for safe design, redundant design, and structural design.
- In the event that any or all HUA XUAN YANG ELECTRONICS products(including technical data, services) described or contained herein are controlled under any of applicable local export control laws and regulations, such products must not be exported without obtaining the export license from the authorities concerned in accordance with the above law.
- No part of this publication may be reproduced or transmitted in any form or by any means, electronic or mechanical, including photocopying and recording, or any information storage or retrieval system, or otherwise, without the prior written permission of HUA XUAN YANG ELECTRONICS CO.,LTD.
- Information (including circuit diagrams and circuit parameters) herein is for example only ; it is not guaranteed for volume production. HUA XUAN YANG ELECTRONICS believes information herein is accurate and reliable, but no guarantees are made or implied regarding its use or any infringements of intellectual property rights or other rights of third parties.
- Any and all information described or contained herein are subject to change without notice due to product/technology improvement, etc. When designing equipment, refer to the "Delivery Specification" for the HUA XUAN YANG ELECTRONICS product that you intend to use.