

Series 228F

7.4 x 7.0mm Illuminated Tactile Switch

- Surface mount gull-wing terminal or standard through hole configurations
- Compatible with IR reflow, manual soldering
- Single color display during illumination
- Variety of LED color options
- Halogen Free



Ordering Information

Series	Terminal Type	Actuating Direction	Actuation Force	LED Color	LED Type	Packaging
228F	D	S	A	R	B	R

Code	Spec.
D	Standard through hole
M	Surface mount gull wing

Code	Spec.
V	Vertical
*S	Side

*Side actuation is only available with standard through hole terminal

Code	Spec.
A	Amber
B	Blue
G	Pure Green
L	Olive Green
R	Red
W	White
Y	Yellow
BA	Blue & Amber
GA	Pure Green & Amber
LA	Olive Green & Amber
LR	Olive Green & Red
LY	Olive Green & Yellow
RB	Red & Blue
RL	Red & Olive Green
WA	White & Amber
YW	Yellow & Red

Code	Spec.
R	Tape & reel packaging (only available for surface mount gull wing type)
Blank	Tray packaging (only available for side standard through hole type)
B	Tube packaging (only available for vertical standard through hole type)

	228FDV	228FMV	228FDS
A	v	v	v
B	v	v	v
G			v
L	v	v	v
R	v	v	v
W	v	v	v
Y	v	v	v

	228FDV	228FMV	228FDS
BA	v	v	v
GA			v
LA	v	v	
LR			v
LY	v	v	v
RB	v	v	v
RL	v	v	
WA			v
YW	v	v	

Code	Spec.
A	160 gf

Consult CTS if you have demands for specific cap type

Electrical Specifications

Parameter	Conditions & Remarks	Min	Max	Unit
Contact Resistance			100	milliohms
Insulation Resistance	Between insulated terminals	100		megohms
Dielectric Strength	250 VAC between adjacent switches		1	minute
Nonswitching Rating			50 or 12	mA or VDC

Mechanical and Environmental

Soldering	Maximum manual temperature, 350°C for 3 seconds Maximum reflow temperature, 260°C for 5 seconds (vertical standard though hole) Maximum reflow temperature, 255°C for 5 seconds (side standard though hole) Maximum reflow temperature, 260°C for 3 seconds (vertical surface mount)
RoHS	Lead-Free. Fully compliant to RoHS Directive 2011/65/EU
Halogen Free	Halogen Free
Operating Force	160±50 gf
Actuation Life	228FMV/228FDS: 100,000 cycles 228FDV: 500,000 cycles
Actuator Strength	Push: 3 Kgf maximum Pull: 1 Kgf minimum
Travel	0.25 ^{+0.2} _{-0.1} mm
Packaging	Tray packaging for side standard though hole Tube packaging for vertical standard through hole Tape & Reel packaging for vertical surface mount
Operating Temperature Range	-20°C to +70°C
Storage Temperature Range	-30°C to +80°C

Soldering Profile

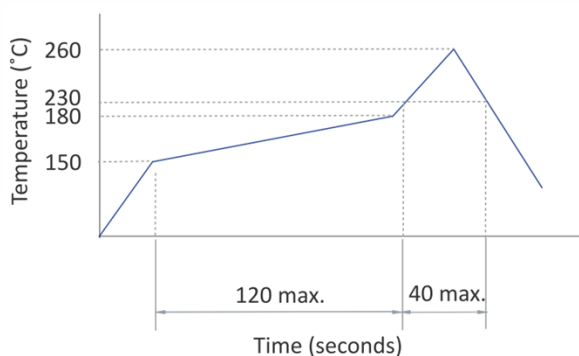

LED Specifications for Vertical Actuation Product

Color	Reversed Voltage (Max)	Reversed Current (Max)	Recommended Operating Current	Forward Voltage at 20mA		Chromaticity Coordinates	
				Nor	Max		
Red	5 Vdc	100 μ A	30 mA	2.1V	2.6V	0.32	0.33
Olive Green	5 Vdc	100 μ A	30 mA	2.0V	2.6V		
Yellow	5 Vdc	100 μ A	30 mA	2.1V	2.6V		
Amber	5 Vdc	100 μ A	30 mA	2.0V	2.6V		
Blue	5 Vdc	100 μ A	30 mA	3.2V	3.6V		
				Forward Voltage at 5mA			
White	5 Vdc	100 μ A	30 mA	2.8V	3.2V		

LED Specifications for Side Actuation Product

Color	Reversed Voltage (Max)	Reversed Current (Max)	Recommended Operating Current	Forward Voltage at 20mA		Chromaticity Coordinates	
				Nor	Max		
Red	5 Vdc	100 μ A	20 mA	2.1V	2.6V	0.284	0.275
Olive Green	5 Vdc	100 μ A	20 mA	2.0V	2.6V		
Yellow	5 Vdc	100 μ A	20 mA	2.1V	2.6V		
Amber	5 Vdc	100 μ A	20 mA	2.0V	2.6V		
Blue	5 Vdc	100 μ A	20 mA	3.2V	3.8V		
Pure Green	5 Vdc	100 μ A	20 mA	3.0V	4.0V		
White	5 Vdc	100 μ A	20 mA	3.2V	3.8V		

Mechanical Specifications
Figure 1 – 228FDV, Standard Though Hole, Vertical Actuation

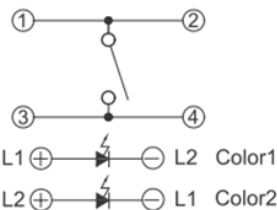
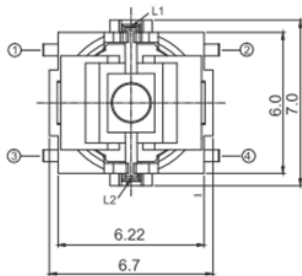

CIRCUIT DIAGRAM

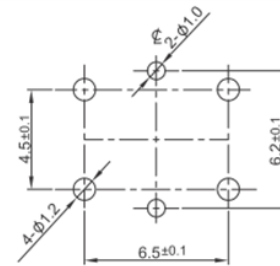

PCB LAYOUT

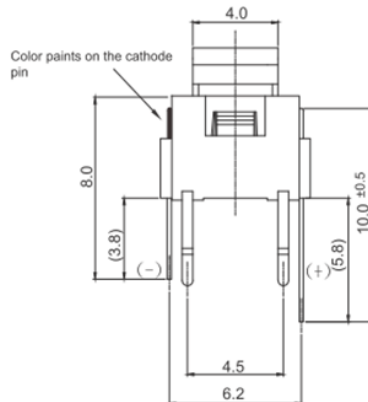
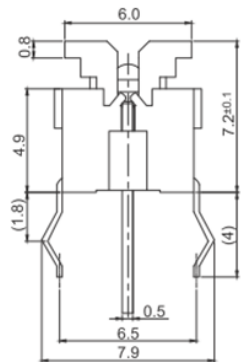

DIMENSION : mm
STANDARD TOLERANCE : ± 0.3

Figure 2 – 228FMV, Surface Mount Gull Wing, Vertical Actuation

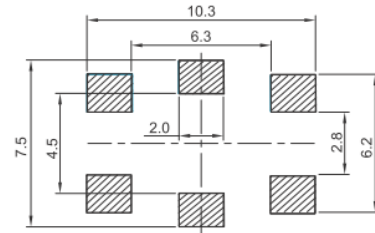
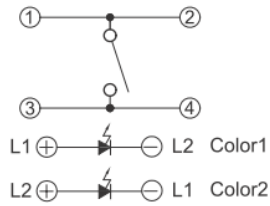
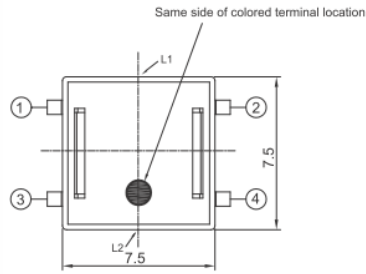

CIRCUIT DIAGRAM

PCB LAYOUT

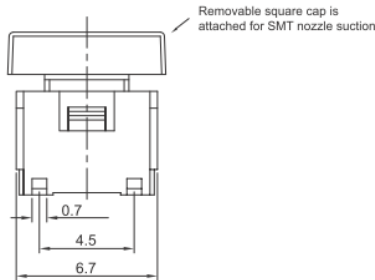
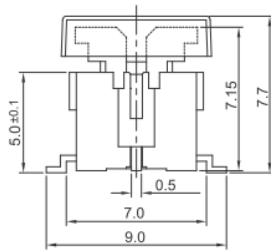

DIMENSION : mm
STANDARD TOLERANCE : ±0.3

Figure 3 – 228FDS, Standard Through Hole, Side Actuation

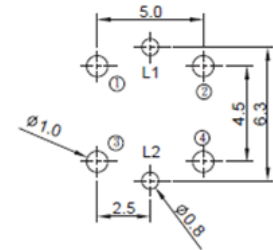
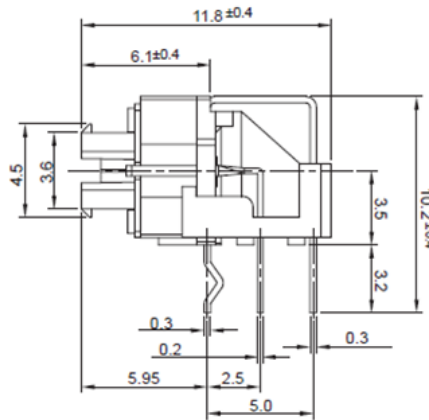
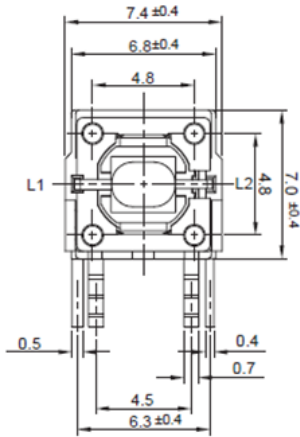

CIRCUIT DIAGRAM

PCB LAYOUT

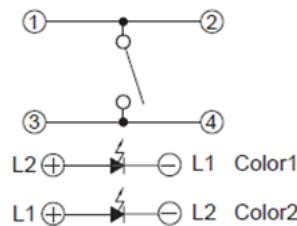
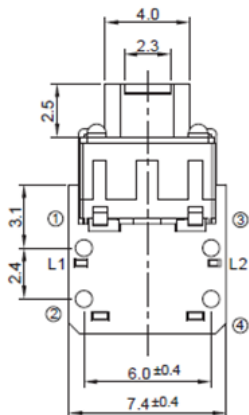

DIMENSION : mm
STANDARD TOLERANCE : ±0.3

Packing: Tape and Reel

Surface Mount Gull Wing, Actuator Height 7.7mm

The packing specifications:

1. Structure and materials:

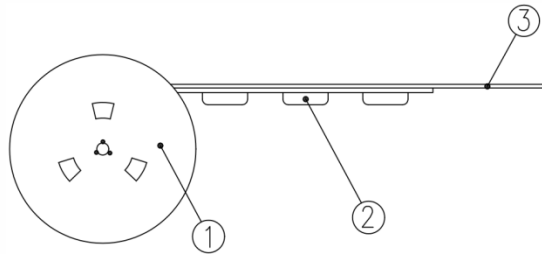

No	PART NAME	MATERIAL
①	REEL	POLYSTYRENE
②	CARRIER TAPE	POLYSTYRENE
③	COVER TAPE	POLYESTER

2. Packing quantity: 500 pcs/reel
3. More than 160mm empty pockets should remain at each end of the carrier tape for each reel. After reel packaging, the end of tape 180mm, shall be empty and the tape edge shall be cut in 45°. The cover tape shall be extended 180±10 mm from the tape edge and fixed with tape.
4. Shortage of less than 2 pcs a reel is acceptable.
5. Stripping strength of cover tape is between 10 gf to 130 gf and stripping angle should be within 165°~180°.
6. The product in the pocket of carrier tape should be placed in a specified correct position.
7. Tape and reel per EIA-481.
8. Dimensions:

