



Series 226B

3.5x2.9mm Compact Tactile Switch

- Surface mount gull-wing terminal configurations
- Compatible with IR reflow and manual soldering



Ordering Information

Series	Terminal Type	Actuating Direction	Actuator Height	Actuator Force	Packaging	Ground Terminal																		
226B	J	V	A	A	R	G																		
	<table border="1"> <thead> <tr> <th>Code</th> <th>Spec.</th> </tr> </thead> <tbody> <tr> <td>J</td> <td>Surface mount J bend</td> </tr> </tbody> </table>	Code	Spec.	J	Surface mount J bend		<table border="1"> <thead> <tr> <th>Code</th> <th>Spec.</th> </tr> </thead> <tbody> <tr> <td>A</td> <td>1.7mm</td> </tr> </tbody> </table>	Code	Spec.	A	1.7mm		<table border="1"> <thead> <tr> <th>Code</th> <th>Spec.</th> </tr> </thead> <tbody> <tr> <td>R</td> <td>Tape & reel packaging</td> </tr> </tbody> </table>	Code	Spec.	R	Tape & reel packaging	<table border="1"> <thead> <tr> <th>Code</th> <th>Spec.</th> </tr> </thead> <tbody> <tr> <td>G</td> <td>With ground terminal</td> </tr> <tr> <td>Blank</td> <td>No ground terminal</td> </tr> </tbody> </table>	Code	Spec.	G	With ground terminal	Blank	No ground terminal
Code	Spec.																							
J	Surface mount J bend																							
Code	Spec.																							
A	1.7mm																							
Code	Spec.																							
R	Tape & reel packaging																							
Code	Spec.																							
G	With ground terminal																							
Blank	No ground terminal																							
		<table border="1"> <thead> <tr> <th>Code</th> <th>Spec.</th> </tr> </thead> <tbody> <tr> <td>V</td> <td>Vertical</td> </tr> </tbody> </table>	Code	Spec.	V	Vertical		<table border="1"> <thead> <tr> <th>Code</th> <th>Spec.</th> </tr> </thead> <tbody> <tr> <td>A</td> <td>100 gf, black</td> </tr> <tr> <td>B</td> <td>160 gf, gray</td> </tr> <tr> <td>C</td> <td>200 gf, white</td> </tr> <tr> <td>D</td> <td>350 gf, blue</td> </tr> <tr> <td>E</td> <td>500 gf, brown</td> </tr> </tbody> </table>	Code	Spec.	A	100 gf, black	B	160 gf, gray	C	200 gf, white	D	350 gf, blue	E	500 gf, brown				
Code	Spec.																							
V	Vertical																							
Code	Spec.																							
A	100 gf, black																							
B	160 gf, gray																							
C	200 gf, white																							
D	350 gf, blue																							
E	500 gf, brown																							

Notes: Contact CTS for other common features not listed.

Electrical Specifications

Parameter	Conditions & Remarks	Min	Max	Unit
Contact Resistance			100	milliohms
Insulation Resistance	Between insulated terminals	100		Megohms
Dielectric Strength	1 minute between adjacent switches		250	VAC
Nonswitching Rating			50 or 12	mA or VDC

Mechanical and Environmental

Soldering	Maximum reflow temperature, 260°C for 5 seconds Maximum manual temperature, 350°C for 3 seconds
RoHS	Lead-Free. Fully compliant to RoHS Directive 2011/65/EU
Operating Force	100±50 gf 160±50 gf 200±50 gf 350±100 gf 500±100 gf
Actuation Life	100 gf: 1,000,000 cycles 160 gf: 200,000 cycles 200 gf: 200,000 cycles 350 gf: 200,000 cycles 500 gf: 100,000 cycles
Actuator Strength	3 Kgf maximum
Travel	0.15±0.1 mm
Packaging	Standard tape and reel packaging
Operating Temperature Range	-40°C to +85°C
Storage Temperature Range	-40°C to +85°C

Soldering Profile

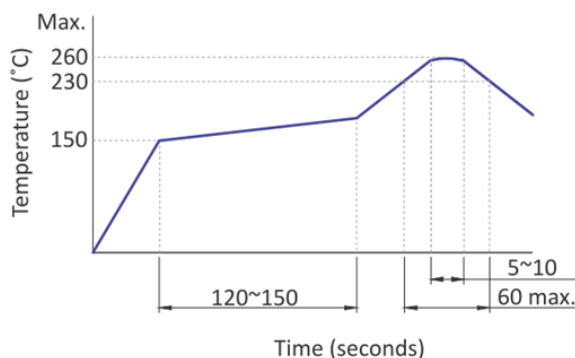

Mechanical Specifications

Figure 1 –226BJ... Surface Mount J Bend, Without Ground Terminal

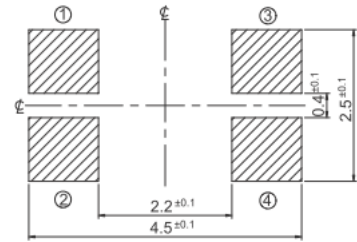
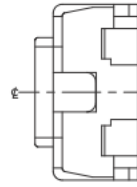
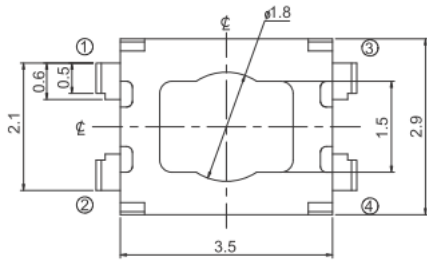

CIRCUIT DIAGRAM

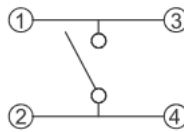

PCB LAYOUT

DIMENSION : mm
STANDARD TOLERANCE :
.X (1 PLACE) : ±0.20

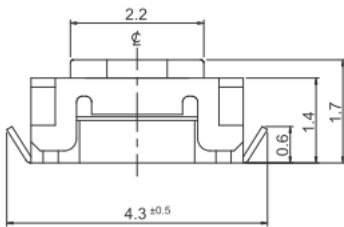
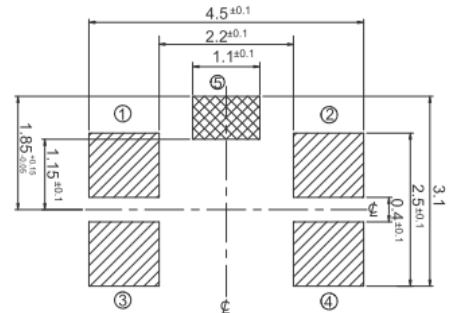
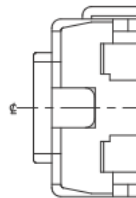
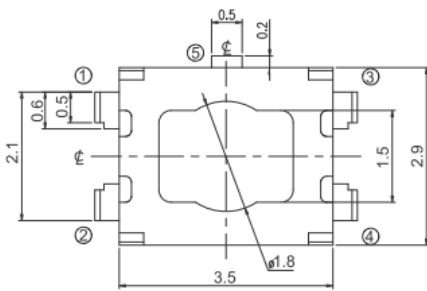
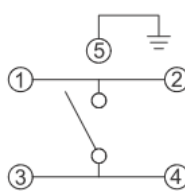

Figure 2 –226BJ...G Surface Mount J Bend, With Ground Terminal



CIRCUIT DIAGRAM



PCB LAYOUT

DIMENSION : mm
STANDARD TOLERANCE :
.X (1 PLACE) : ±0.20

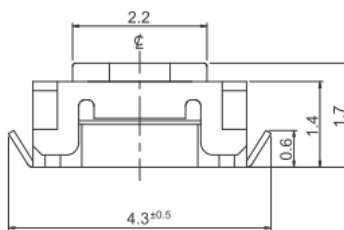

Packing: Tape and Reel

Surface Mount J Bend

The packing specifications :

Structure and materials :

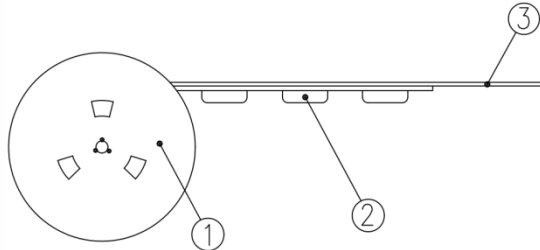

③	COVER TAPE	POLYESTER
②	CARRIER TAPE	POLYSTYRENE
①	REEL	POLYSTYRENE
NO.	PARTS NAME	MATERIALS

1. Packing quantity : 4,000 pcs/reel
2. More than 10 empty pockets should remain at each end of the carrier tape for each reel.
3. Shortage less than 10 pcs a reel is acceptable but no more than 3 consecutive empty pockets are allowed.
4. Stripping strength of cover tape is between 10 gf to 70 gf and stripping angle should be within 165°~180°.
5. The product in the pocket of carrier tape should be placed in a specified correct position.
6. Tape and reel per EIA-481
7. Dimensions :

