

SPECIFICATIONS

Current Rating: 3Amps
 Insulation Resistance: 1000MΩ Min
 Contact Resistance: 20mΩ Max
 Withstanding Voltage: AC 1000V
 Operation Temperature: -40° to +105°
 Contact Material: Brass
 Insulator Material: Polyester (UL 94V-0)
 Contact plating: Gold Flash
 Standard: PA6T
 Max. Processing Temp: 240° C for 30-60 seconds
 (260° C for 10 seconds)

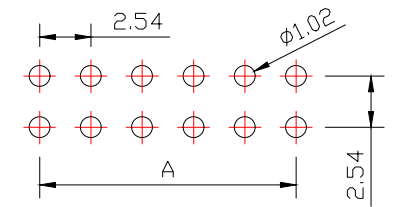

RECOMMEND P. C. B LAYOUT
 PCB TOLERANCE: ±0.05 (TOP VIEW)

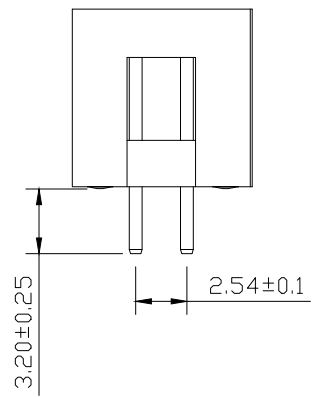
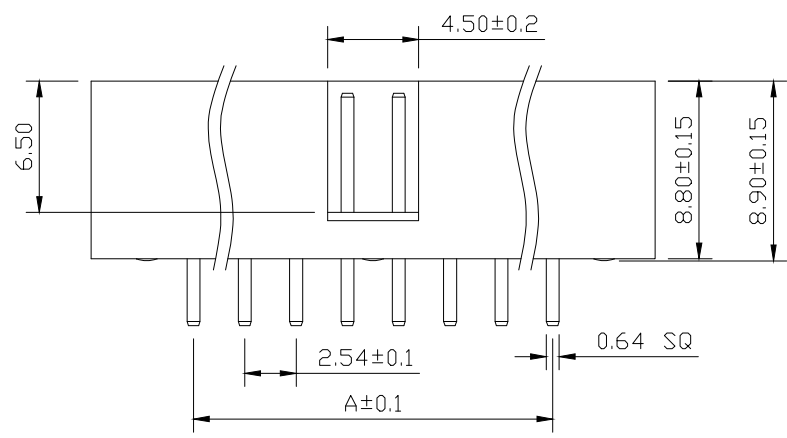
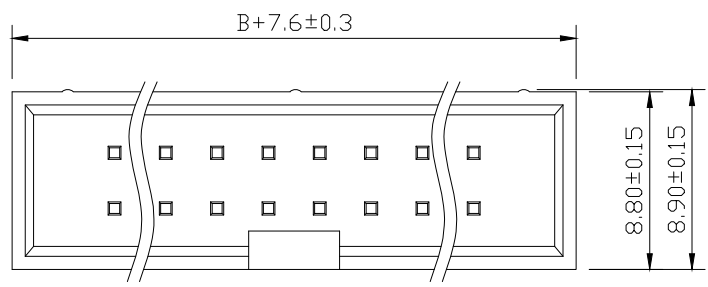
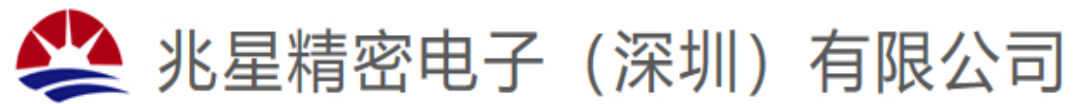

No. of	DIM. A	DIM. B	No. of	DIM. A	DIM. B	No. of	DIM. A	DIM. B
6	5.08	7.62	20	22.86	25.40	36	43.18	45.72
8	7.62	10.16	24	27.94	30.48	40	48.26	50.80
10	10.16	12.70	26	30.48	33.02	44	53.34	55.88
12	12.70	15.24	28	33.02	35.56	50	60.96	63.50
14	15.24	17.78	30	35.56	38.10	60	73.66	76.20
16	17.78	20.32	32	38.10	40.64	64	78.74	81.28
18	20.32	22.86	34	40.64	43.18			

UNLESS OTHERWISE SPECIFIED TOLERANCE
 X : ±0.30 X° : ±5°
 X.X : ±0.25 X.X° : ±1°
 X.XX : ±0.20 X.XX° : ±0.5°

DRAWN NAME: 2.54DC3-NPin H8.9 180度 PC3.2 L11.5 6T
 SIZE: A4 SCALE: N:1 PROUCT NO.: ZX-1DC2.54-2-10PZZ
 REV: A UNIT: mm PROJECT: PAGE: 1/1

CHECKED: / / / APPROVED: / / /