

MSKSEMI 美森科

SEMICONDUCTOR



ESD



TVS



TSS



MOV



GDT



PLED

MMBTA92-MS



Product specification

TRANSISTOR (PNP)

FEATURES

- High voltage transistor

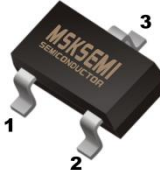
Reference News

PACKAGE OUTLINE	MARKING
 <p>1. BASE 2. EMITTER 3. COLLECTOR</p>	
SOT-23	

MAXIMUM RATINGS (Ta=25°C unless otherwise noted)

Symbol	Parameter	Value	Unit
V _{CB0}	Collector-Base Voltage	-300	V
V _{CEO}	Collector-Emitter Voltage	-300	V
V _{EBO}	Emitter-Base Voltage	-5	V
I _c	Collector Current -Continuous	-200	mA
I _{CM}	Collector Current -Pulsed	-500	mA
P _c	Collector Power Dissipation	300	mW
T _j	Junction Temperature	150	°C
T _{stg}	Storage Temperature	-55-150	°C
R _{θJA}	Thermal Resistance from Junction to Ambient	417	°C/W

ELECTRICAL CHARACTERISTICS (Ta=25°C unless otherwise specified)

Parameter	Symbol	Test conditions	Min	Max	Unit
Collector-base breakdown voltage	V _{(BR)CBO}	I _c = -100μA, I _E =0	-300		V
Collector-emitter breakdown voltage	V _{(BR)CEO}	I _c = -1mA, I _B =0	-300		V
Emitter-base breakdown voltage	V _{(BR)EBO}	I _E = -100μA, I _C =0	-5		V
Collector cut-off current	I _{CBO}	V _{CB} =-200V, I _E =0		-0.25	μA
Emitter cut-off current	I _{EBO}	V _{EB} = -5V, I _C =0		-0.1	μA
DC current gain	h _{FE(1)}	V _{CE} = -10V, I _C = -1mA	60		
	h _{FE(2)}	V _{CE} = -10V, I _C =-10mA	100	200	
	h _{FE(3)}	V _{CE} = -10V, I _C =-30mA	60		
Collector-emitter saturation voltage	V _{CE(sat)}	I _C =-20mA, I _B = -2mA		-0.2	V
Base-emitter saturation voltage	V _{BE(sat)}	I _C = -20mA, I _B = -2mA		-0.9	V
Transition frequency	f _T	V _{CE} =-20V, I _C = -10mA f=30MHz	50		MHz

Typical Characteristics

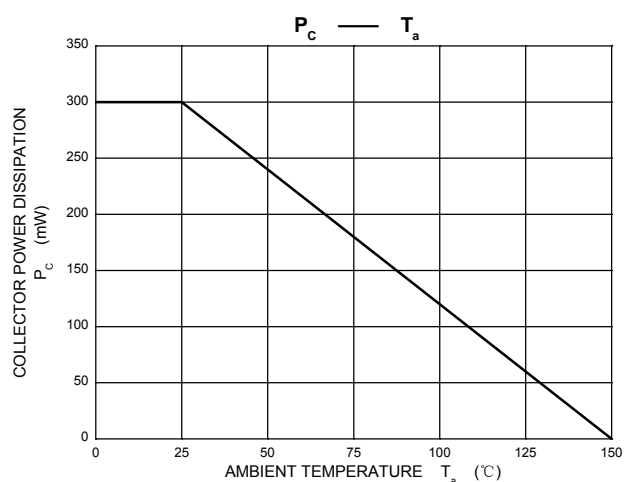
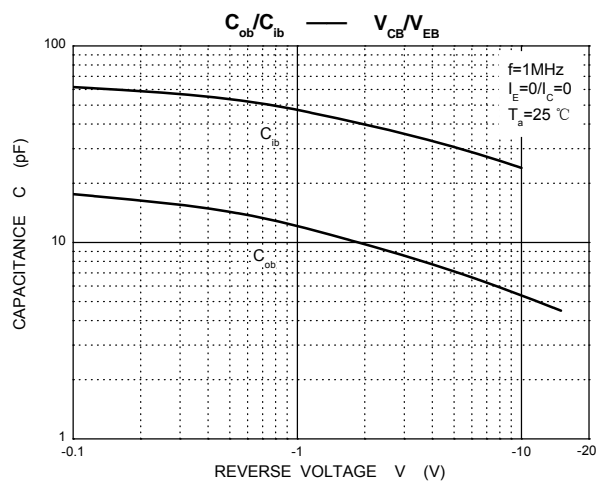
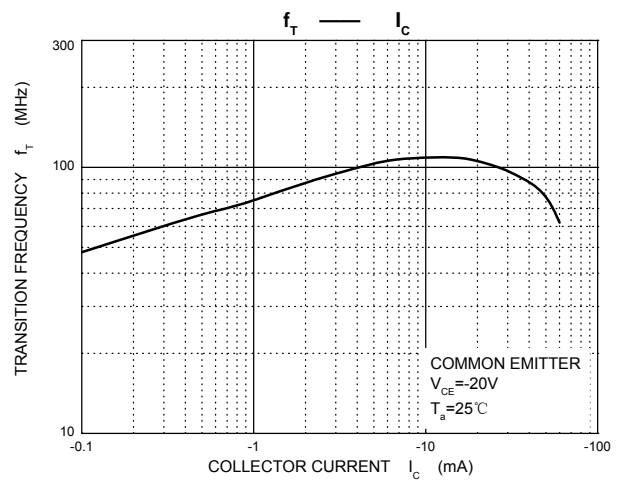
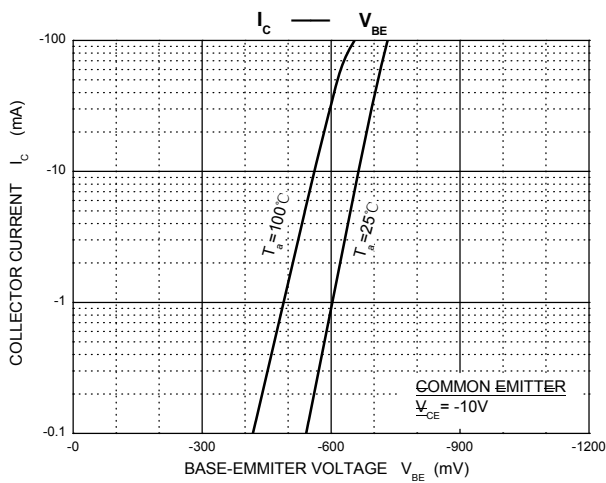
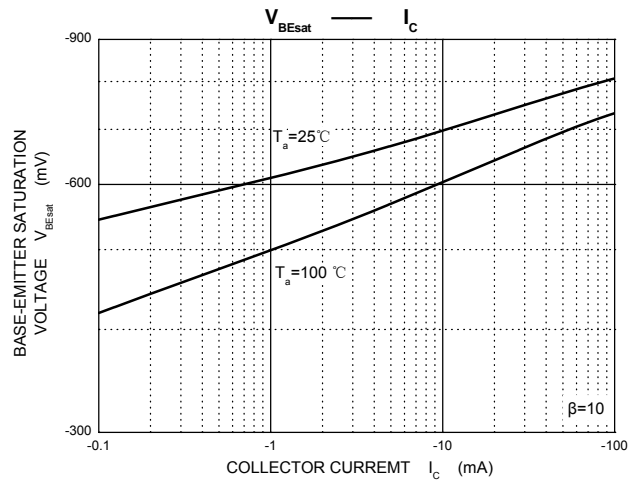
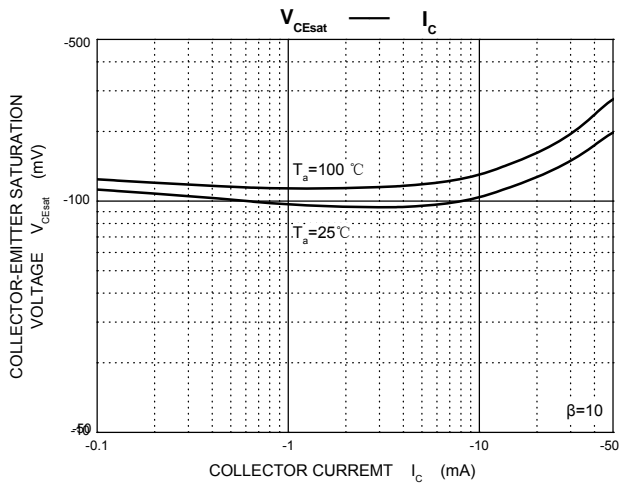
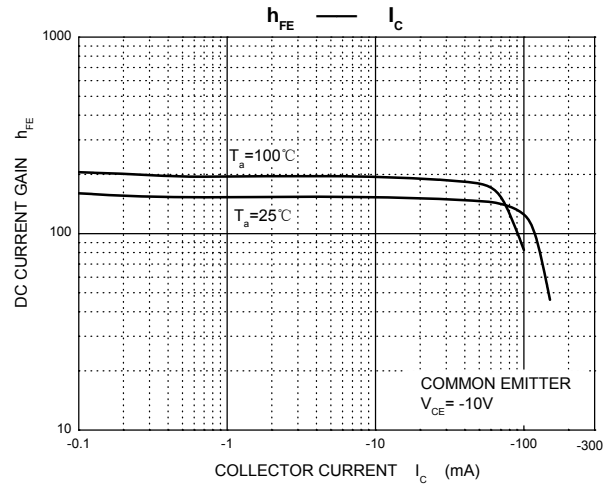
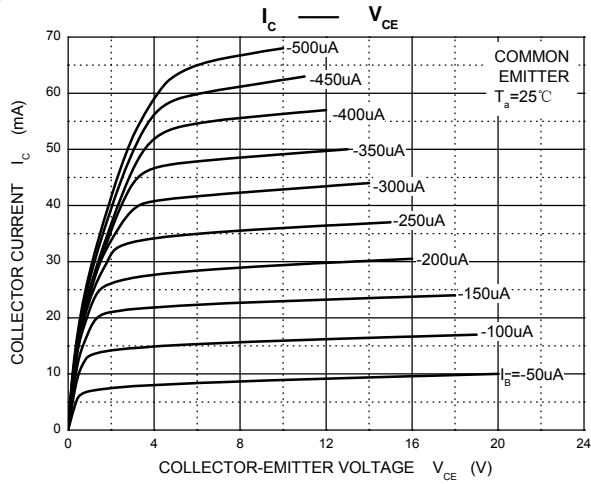

PACKAGE MECHANICAL DATA

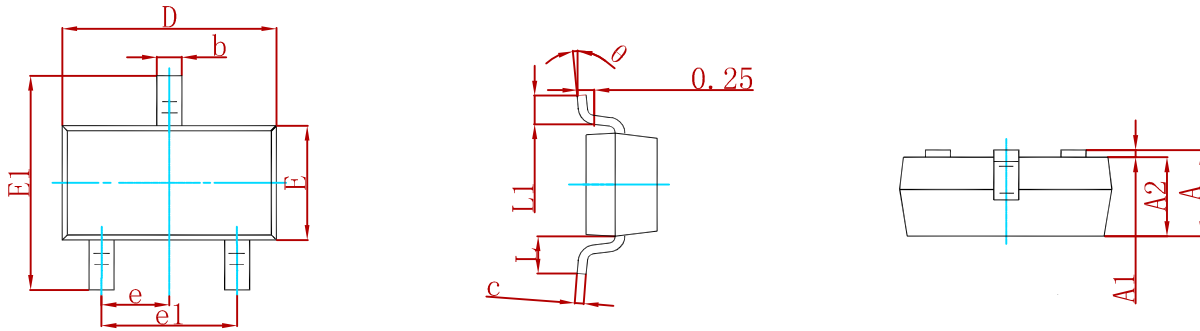

Symbol	Dimensions In Millimeters		Dimensions In Inches	
	Min	Max	Min	Max
A	0.900	1.150	0.035	0.045
A1	0.000	0.100	0.000	0.004
A2	0.900	1.050	0.035	0.041
b	0.300	0.500	0.012	0.020
c	0.080	0.150	0.003	0.006
D	2.800	3.000	0.110	0.118
E	1.200	1.400	0.047	0.055
E1	2.250	2.550	0.089	0.100
e	0.950 TYP		0.037 TYP	
e1	1.800	2.000	0.071	0.079
L	0.550 REF		0.022 REF	
L1	0.300	0.500	0.012	0.020
θ	0°	8°	0°	8°

Suggested Pad Layout

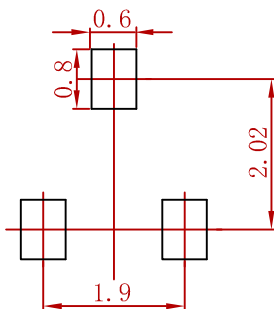

Note:
 1. Controlling dimension: in millimeters.
 2. General tolerance: ± 0.05mm.
 3. The pad layout is for reference purposes only.

REEL SPECIFICATION

P/N	PKG	QTY
MMBTA92-MS	SOT-23	3000

Attention

- Any and all MSKSEMI Semiconductor products described or contained herein do not have specifications that can handle applications that require extremely high levels of reliability, such as life-support systems, aircraft's control systems, or other applications whose failure can be reasonably expected to result in serious physical and/or material damage. Consult with your MSKSEMI Semiconductor representative nearest you before using any MSKSEMI Semiconductor products described or contained herein in such applications.
- MSKSEMI Semiconductor assumes no responsibility for equipment failures that result from using products at values that exceed, even momentarily, rated values (such as maximum ratings, operating condition ranges, or other parameters) listed in products specifications of any and all MSKSEMI Semiconductor products described or contained herein.
- Specifications of any and all MSKSEMI Semiconductor products described or contained herein stipulate the performance, characteristics, and functions of the described products in the independent state, and are not guarantees of the performance, characteristics, and functions of the described products as mounted in the customer's products or equipment. To verify symptoms and states that cannot be evaluated in an independent device, the customer should always evaluate and test devices mounted in the customer's products or equipment.
- MSKSEMI Semiconductor strives to supply high-quality high-reliability products. However, any and all semiconductor products fail with some probability. It is possible that these probabilistic failures could give rise to accidents or events that could endanger human lives, that could give rise to smoke or fire, or that could cause damage to other property. When designing equipment, adopt safety measures so that these kinds of accidents or events cannot occur. Such measures include but are not limited to protective circuits and error prevention circuits for safe design, redundant design, and structural design.
- In the event that any or all MSKSEMI Semiconductor products (including technical data, services) described or contained herein are controlled under any of applicable local export control laws and regulations, such products must not be exported without obtaining the export license from the authorities concerned in accordance with the above law.
- No part of this publication may be reproduced or transmitted in any form or by any means, electronic or mechanical, including photocopying and recording, or any information storage or retrieval system, or otherwise, without the prior written permission of MSKSEMI Semiconductor.
- Information (including circuit diagrams and circuit parameters) herein is for example only ; it is not guaranteed for volume production. MSKSEMI Semiconductor believes information herein is accurate and reliable, but no guarantees are made or implied regarding its use or any infringement of intellectual property rights or other rights of third parties.
- Any and all information described or contained herein are subject to change without notice due to product/technology improvement, etc. When designing equipment, refer to the "Delivery Specification" for the MSKSEMI Semiconductor product that you intend to use.