

REV.	Q'TY	ECN. NO.	APR.	DATE

序号	品名	材质
1	0.5插拔卧式下接胶芯(H2.0)	LCP UL94V-0 本色
2	0.5插拔卧式下接端子(H2.0)	铜合金/表面镀锡
3	0.5插拔卧式下接后盖(H2.0)	LCP UL94V-0 黑色
4	0.5插拔卧式下接焊片(H2.0)	铜合金/表面镀锡

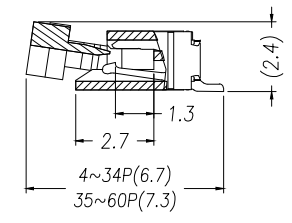
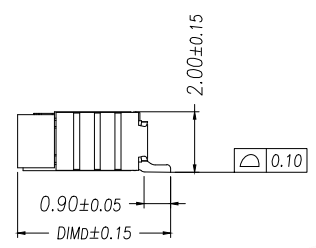
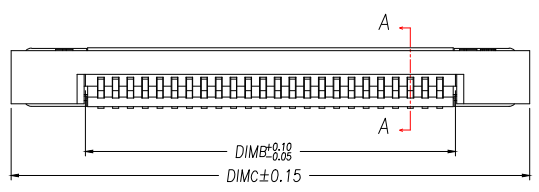
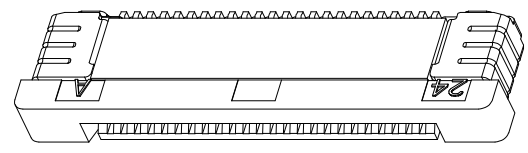
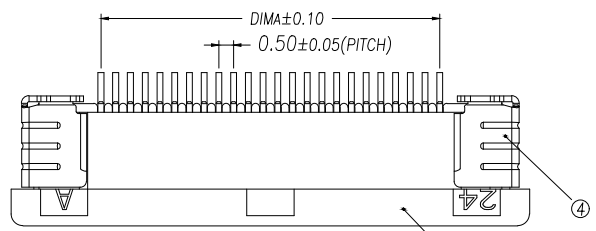

技术指标(Technical Index):

1. 塑件表面应光洁、无毛边、无明显收缩、缺陷、裂纹等现象。  
(The surface of the plastic parts should be smooth, no rough edges, no obvious shrinkage, defects, cracks and other phenomena.)
2. 温度范围(Temperature range): -25° C~+85° C.
3. 额定电压(Rated voltage): 50V, AC/DC(=等效).
4. 接触电阻(Contact resistance): ≤0.03Ω.
5. 绝缘电阻(Insulation resistance): ≥500MΩ.

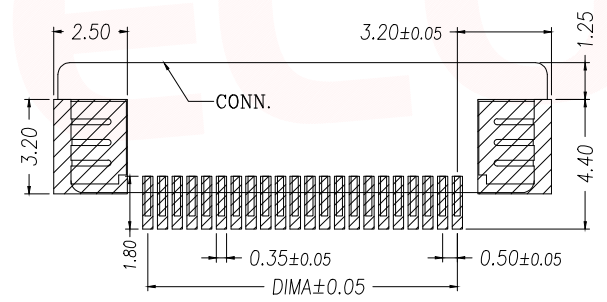
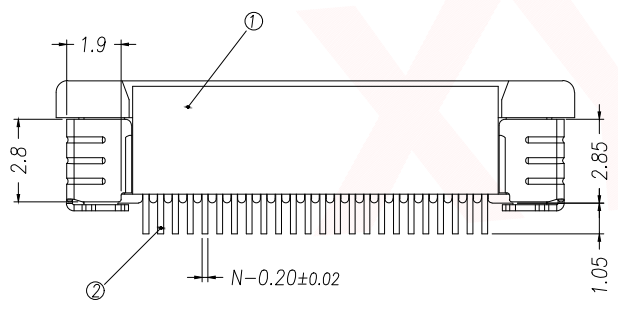

适用线路板(PCB LAYOUT)

Part No	Pin	A	B	C	D	
FPC03-X0.5-4AH2.0	4	1.50	2.56	7.60	5.20	
FPC03-X0.5-5AH2.0	5	2.00	3.06	8.10		
FPC03-X0.5-6AH2.0	6	2.50	3.56	8.60		
FPC03-X0.5-7AH2.0	7	3.00	4.06	9.10		
FPC03-X0.5-8AH2.0	8	3.50	4.56	9.60		
FPC03-X0.5-9AH2.0	9	4.00	5.06	10.10		
FPC03-X0.5-10AH2.0	10	4.50	5.56	10.60		
FPC03-X0.5-11AH2.0	11	5.00	6.06	11.10		
FPC03-X0.5-12AH2.0	12	5.50	6.56	11.60		
.....	.....	.....	.....	.....		
FPC03-X0.5-34AH2.0	34	16.50	17.56	22.60		5.75
FPC03-X0.5-35AH2.0	35	17.00	18.06	23.10		
FPC03-X0.5-36AH2.0	36	17.50	18.56	23.60		
.....	.....	.....	.....	.....		
FPC03-X0.5-60AH2.0	60	(60-1)*0.5	(60+1)*0.5+0.06	(60+11)*0.5+0.1		

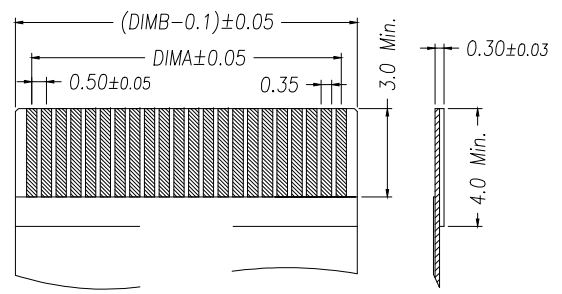

适用扁平线(Applicable Flat Cable)

DIMENSION IN mm		<p>厦门市辛译精密电子有限公司 Xiamen XinYi Xyecom Electronics Co.,Ltd</p>			
TOLERANCE UNLESS OTHERWISE SPECIFIED					
.X±0.35	X.*±5°	APR.	Alex	TITLE: 0.5 Pitch 插拔式下接 H2.0	
.XX±0.25	.X*±3°	CHK.	Jack	DWG NO. FPC03-X0.5-NAH2.0	
.XXX±0.15	.XX*±1°	DRA.	Can	PROJ.  CUSTOMER DRAWING	
		SIZE	A4	SCALE	1:1
		SHEET	1/1	REV.	A