

Specification of MEMS Microphone

RoHS Compliance & Halogen Free

LinkMems P/N: LMA2718T381-OC3

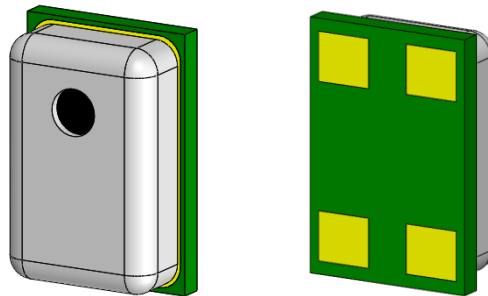

Designed by	Checked by	Approved by
Kevin	Thomas	Hary

Customer Approval

Approved by: _____



Contents

1. Introduction	3
2. Electrical Characteristics	3
3. Frequency Response Curve	4
3.1. Frequency Response Curve	4
4. Test Setup	4
5. Measurement Circuit	4
6. Mechanical Characteristics	5
6.1. Weight	5
6.2. Appearance Drawing	5
7. Application	6
7.1. Pickup Tool Pick Location & PCB Solder Pad Layout	6
7.2. Recommended Reflow Process Condition	6
7.3. Storage Condition	6
8. Packaging	7
8.1. Tape & Reel Specification	7
8.2. Packaging Information	8
9. Reliability Test	9

MEMS Microphone

1. Introduction

The LMA2718T MEMS Microphones are integrated with specialized Pre-amplification ASIC to provide high sensitivity, high SNR output from a capacitive audio sensor. It's packaged for surface mounting and high temperature reflow assembly.

2. Electrical Characteristics

Test Condition: $V_{DD}=2.0V$, $23\pm 2^{\circ}C$, $55\pm 10\%R.H.$, unless otherwise specified.

Specification	Symbol	Test Conditions	Min.	Typ.	Max.	Unit
Directivity			Omni-directional			
Sensitivity Range	S	94dB SPL @1kHz	-39	-38	-37	dB
Output Impedance	Z_{out}	94dB SPL @1kHz			300	Ω
Current Consumption	I				200	μA
S/N Ratio	SNR	94dB SPL @1kHz A-Weighted		64		dB(A)
Operating Voltage	V_{DD}		1.6	2.0	3.6	V
Total Harmonic Distortion	THD	94dB SPL @1kHz		0.1	0.5	%
Sensitivity Drop	ΔS	94dB SPL @1kHz $V_{DD}=3.6V\sim 1.6V$			0.5	dB
Acoustic Overload Point	AOP	10% THD @1kHz		128		dB SPL
Power Supply Rejection	PSR	100mVpp Square wave@217Hz, A-weighted		-100		dB

3. Response Curve

3.1 Frequency Response Curve

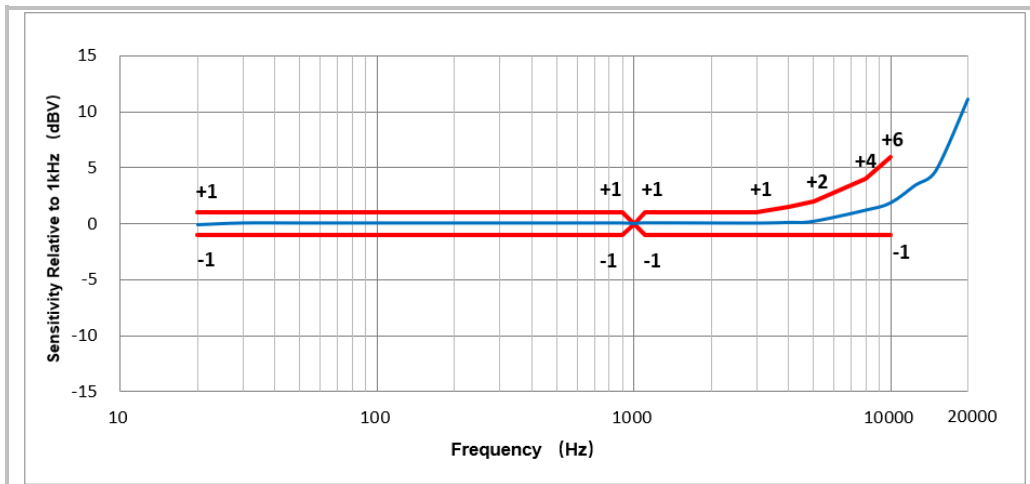

4. Test Setup (Sensitivity Test in Anechoic Room)

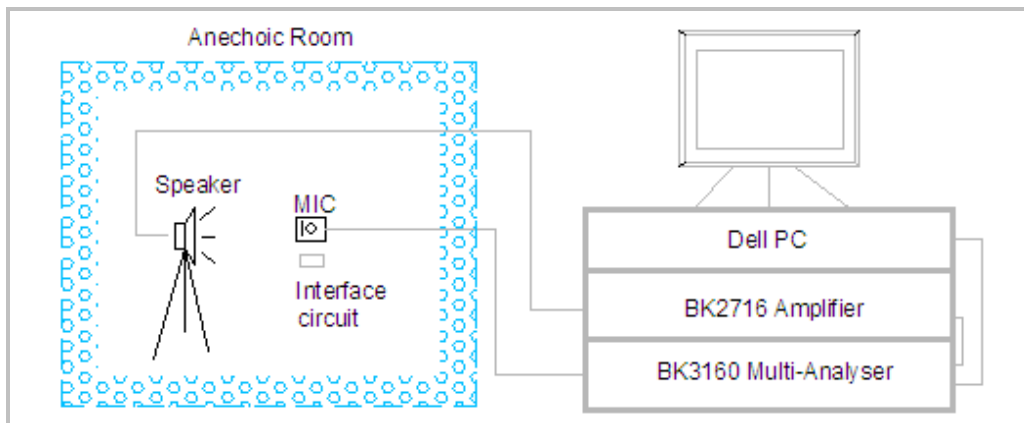

5. Measurement Circuit

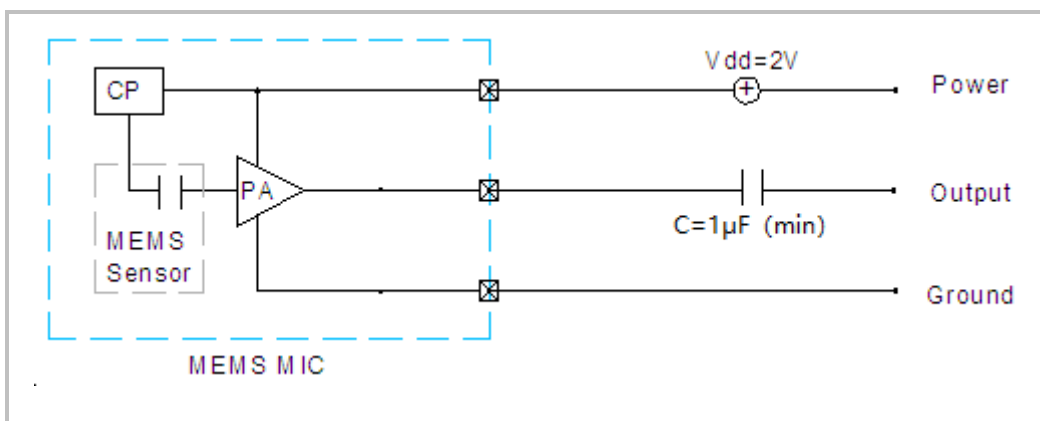

6. Mechanical Characteristics

6.1 Weight: Less than 0.03g

6.2 Appearance Drawing(unit: mm)

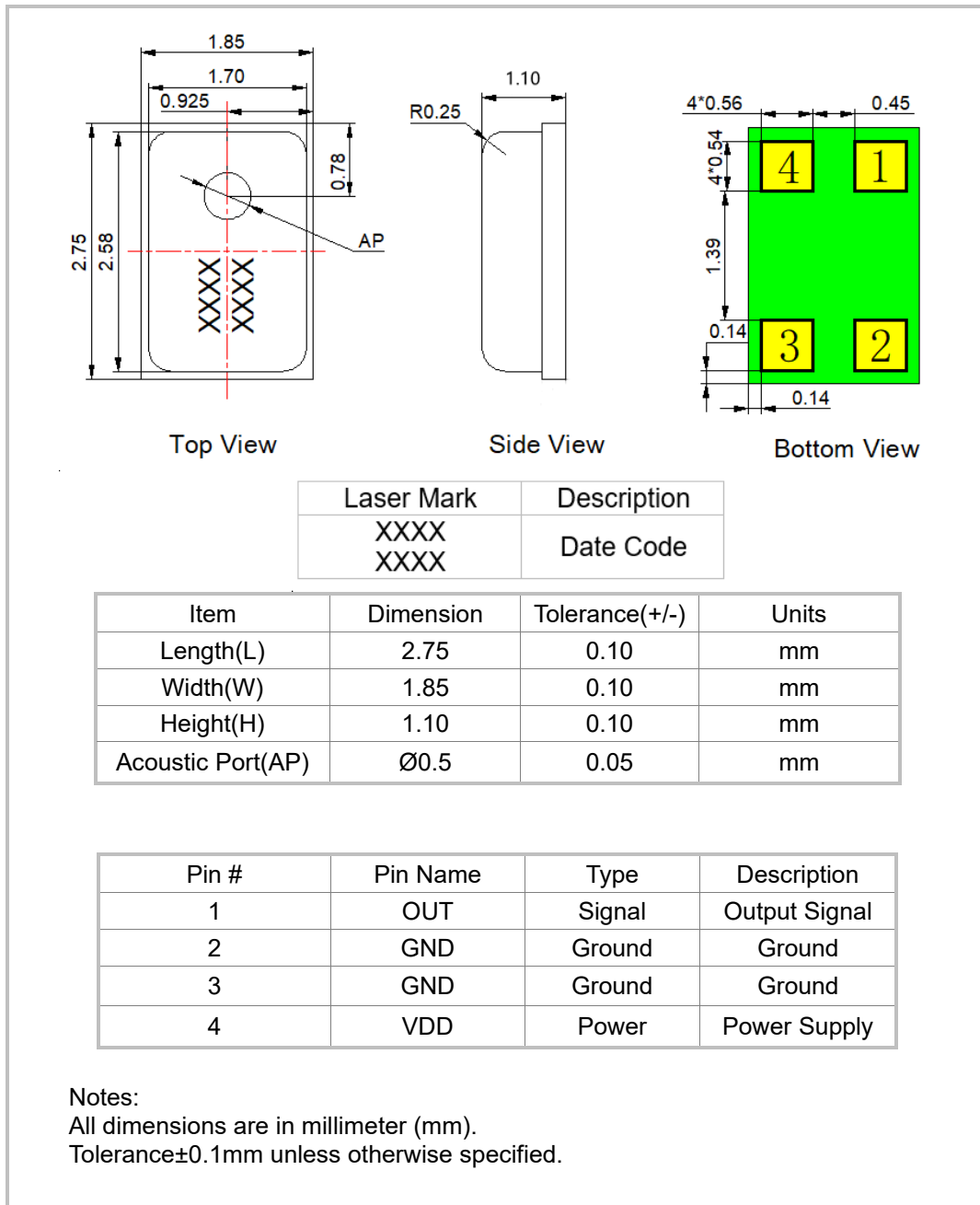

7. Application

7.1 Pickup Tool Pick Location & PCB Solder Pad Layout

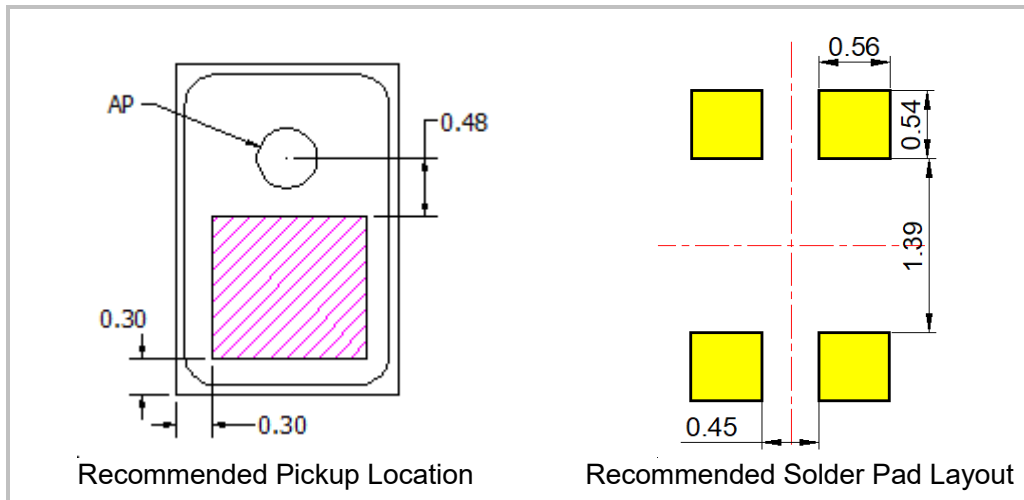

7.2 Recommended Reflow Process Condition

Recommend reflow profile, solder reflow $\leq 260^{\circ}\text{C}$ (for 30s Max of peak temperature).

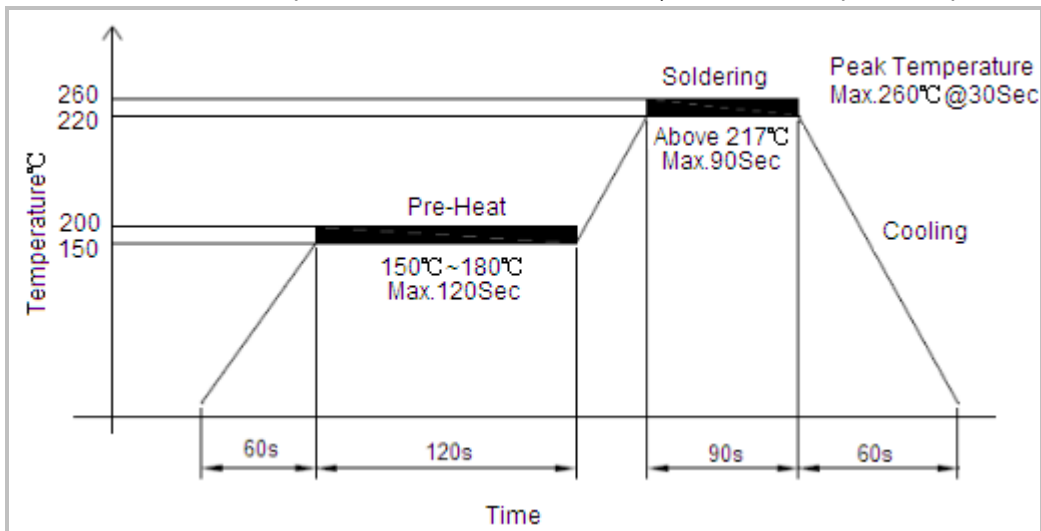

Important Notes

In order to minimize device damage:

1. Do not wash or clean the boards after the reflow process.
2. Do not apply the airflow which pressure over 0.3MPa blow into the port hole within a distance of less than 5 cm.
3. Do not exposed to ultrasonic processing or cleaning.
4. Do not pull a vacuum over port hole of the microphone.

7.3 Storage Condition

7.3.1 Storage temperature range: $-40\sim+100^{\circ}\text{C}$, and humidity is less than 75%.

7.3.2 Operating temperature range: $-40\sim+85^{\circ}\text{C}$.

7.3.3 MSL (moisture sensitivity Level) is Class 1.

8. Packaging

8.1 Tape & Reel Specification

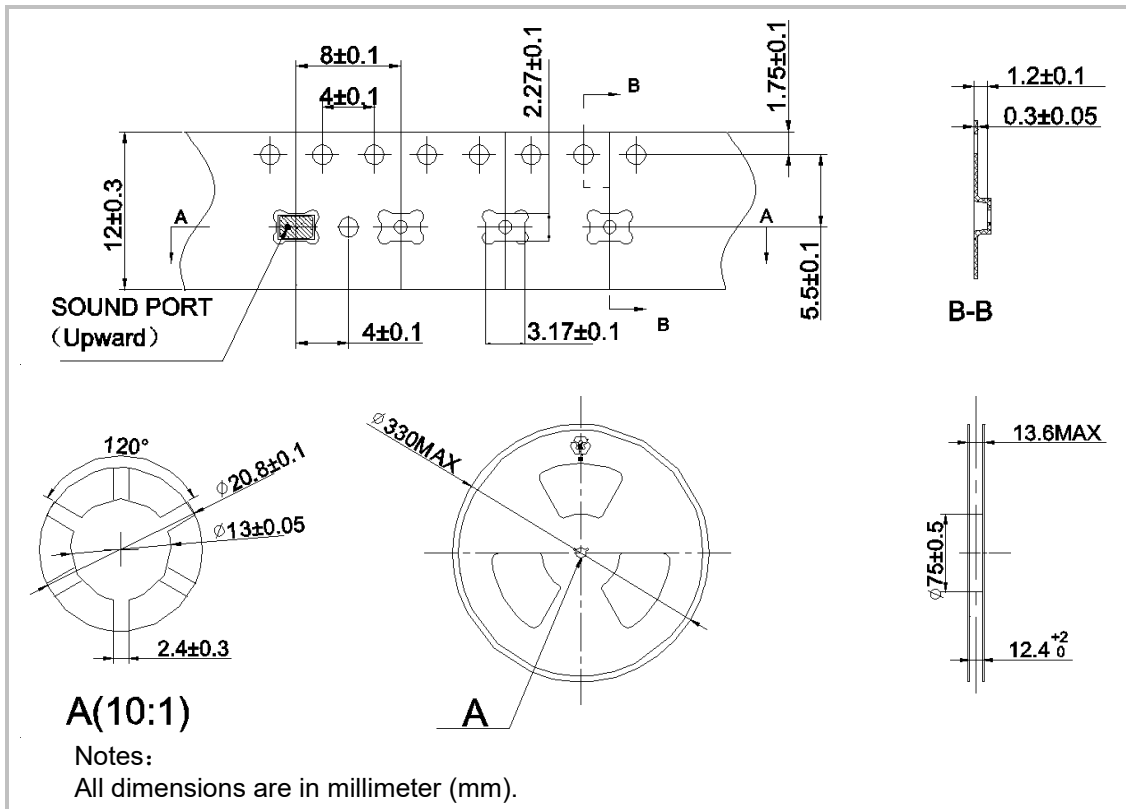

8.2 Packaging Information

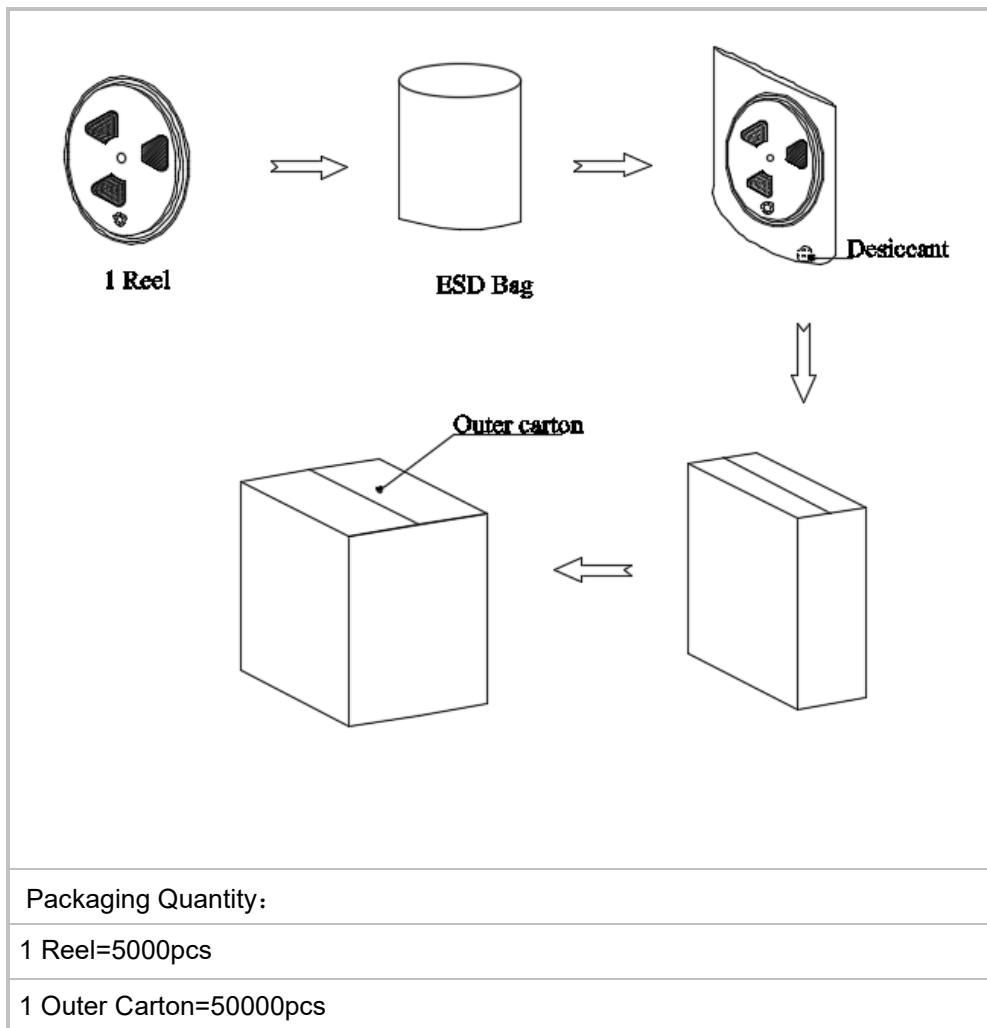

9. Reliability Test

The samples should be placed in the room with $23\pm 2^{\circ}\text{C}$, $55\pm 10\%\text{R.H.}$ for 2 hours at least before final measurement, unless otherwise specified.

Item	Detail	Standard
Simulated Reflow (Without Solder)	Samples for qualification testing require 3 times $260\pm 5^{\circ}\text{C}$ reflow solder profiles. 2 hours of setting time is required between each reflow profile test.	± 3 dB
Static Humidity	Precondition at $+25^{\circ}\text{C}$ for 1 hour. Then expose to $+85^{\circ}\text{C}$ with 85% relative humidity for 240 hours.	± 3 dB
Temperature Shock	Each cycle shall consist of 30 minutes at -40°C , 30 minutes at $+125^{\circ}\text{C}$ with 5 minutes transition time. Test duration is for 30 cycles, starting from cold to hot temperature.	± 3 dB
ESD Sensitivity	According to MIL-STD-883G, Method 3015.7 for Human Body Model. Discharge Position: I/O pins Charge Voltage: $\pm 3000\text{V}$ Discharge Network: 100pF & 1500Ω	± 3 dB
Random Vibrations	Vibrate randomly along three perpendicular directions for 30 minutes in each direction, 4 cycles from $20\text{Hz}\sim 2000\text{Hz}$ with a peak acceleration 20g .	± 3 dB
Mechanical Shock	Subject samples to half sine shock pulses ($3000\text{g}\pm 15\%$ for 0.3ms) in each direction, totally 18 shocks.	± 3 dB
High temperature Storage	Microphone unit must maintain sensitivity after storage at $+105^{\circ}\text{C}$ for 240 hours.	± 3 dB
Low temperature Storage	Microphone unit must maintain sensitivity after storage at -40°C for 240 hours.	± 3 dB
Drop Test	The test was repeated in six directions for 3 times, Dropped from 1.5m height on to a steel surface, total 18 times and inspected for mechanical damage.	± 3 dB

