

Features

- Small Size Design 4.2×5.0×5.0mm Current
- Handling Capability 3,000A @ 8/20 μ s
- Low Capacitance and Insertion Loss
- Fast Response and Long Service Life
- Moisture sensitivity level: Level 1



Exterior

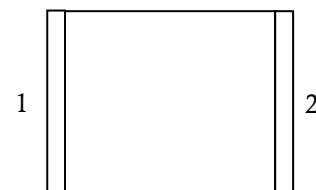

SMD

Application information

- AC Power

Package (Top View)

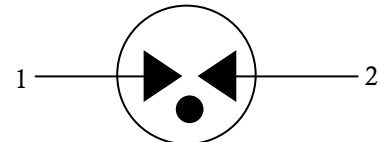
Agency Approvals

Icon	Description
RoHS	Compliance with 2011/65/EU
HF	Compliance with IEC61249-2-21:2003
	Mean lead free
	UL Certificated E232249

Schematic Symbol

Electrical Parameter

DC Breakdown Voltage 1)2)	100V/s	800-1200	V
Impulse Spark-over Voltage	At 1kV/μs	for 99 % of measured values	≤ 1800
	At 1kV/μs	Typical values of distribution	≤ 1700
Impulse Discharge Current 3)	8/20μs	3,000	A
Arc Voltage	At 1A	~15	V
Insulation Resistance	DC=100V	≥1	GΩ
Capacitance at 1MHz	VDC=0.5V	≤1.0	pF
Weight		~0.5	g
Operating And Storage Temperature		-40-90	°C
Marking		Without	

1) At delivery AQL 0.65 level II GB/T 2828.1-2003

2) In ionized mode

3) Terms and waveforms in accordance with ITU-T Rec. K. 12; IEC 61643-21

Part Numbering System

BF 102 M

(1) (2) (3)

(1) Bencent Gas Discharge Tube

(2) Series: DC Breakdown Voltage,

 e.g.: $102=10 \times 10^2=1000V$

 (3) Tolerance of DC Breakdown Voltage, $M=+/-20\%$,
 $N=+/-30\%$, the Specific tolerance is decided by the table
 of "Electrical Parameter"

Product Characteristics

Lead Material	Copper
Body Material	Ceramics
Terminal Finish	100% Matte-Tin Plated

Environmental Reliability Characteristics

Testing items	Technical standards
High Temperature Storage Test	Temperature: 85°C Time: 2H
Low Temperature Storage Test	Temperature: -40°C Time: 2H
Vibration	Frequency: 10-500Hz Amplitude: 0.15mm Time: 45min
Resistance of soldering heat	Temperature: 260±5°C Time of dip soldering: 10s, 1time

Note: Up-screen program can be specified by customer's request via contacting Bencent service

Solderability test

Solderability	Solder Pot Temperature:	245°C ± 5°C
	Solder Dwell Time:	4-6 seconds

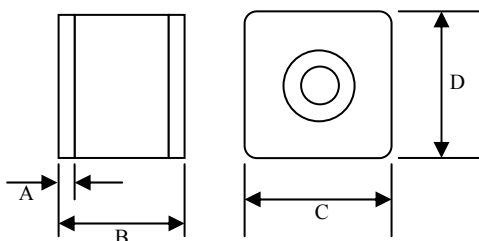
Product Dimensions

REF	mm	inch
A	0.5±0.1	0.020±0.004
B	4.2±0.3	0.165±0.012
C	5.0±0.2	0.197±0.008
D	5.0±0.2	0.197±0.008

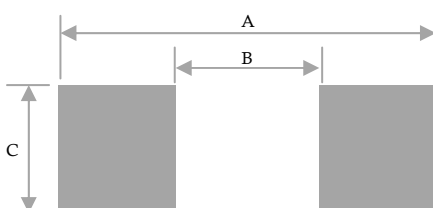
Recommended Soldering Pad

REF	mm	inch
A	4.95	0.195
B	3.0	0.118
C	5.5	0.217

Reflow Profile

Reflow Condition		Pb-Free assembly
Pre Heat	Temperature Min	150°C
	Temperature Max	200°C
	Time (min to max)	60 – 180 secs
Average ramp up rate (Liquids) T _{amp} (T _L) to peak		3°C/second max
T _S (max) to T _L - Ramp-up Rate		3°C/second max
Reflow	- Temperature (T _L) (Liquids)	217°C
	- Temperature (T _L)	60 – 150 seconds
Peak Temperature (T _P)		260±0/-5 °C
Time within 5°C of actual peak Temperature (t _p)		~10 seconds
Ramp-down Rate		6°C/second max
Time 25°C to peak Temperature (T _P)		8 minutes Max.
Do not exceed		260°C

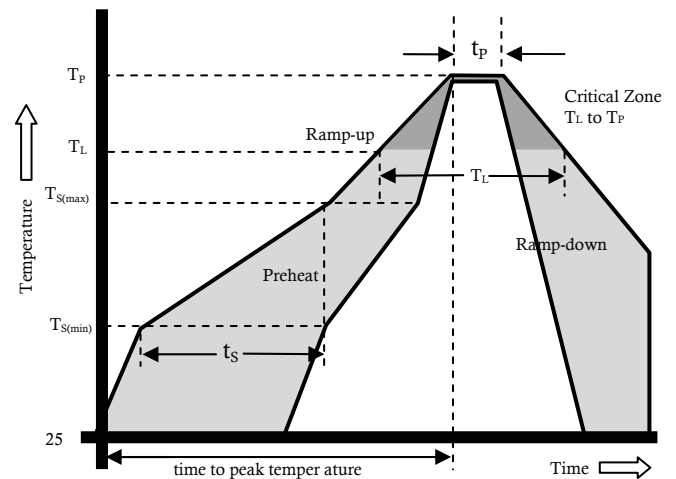
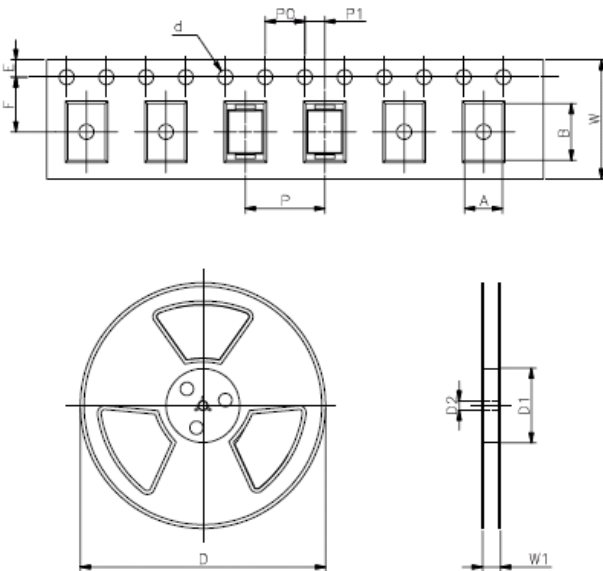
Package Reel Information

REF	mm	inch
A	5.3±0.1	0.209±0.004
B	4.5±0.2	0.177±0.008
d	Φ 1.5±0.1	Φ 0.059±0.004
P0	4.0±0.1	0.157±0.004
P1	2.0±0.1	0.079±0.004
P	12.0±0.1	0.472±0.004
E	1.75±0.1	0.069±0.004
F	7.5±0.1	0.295±0.004
W	16.0±0.3	0.630±0.012
D	Φ 330.0	Φ 13.0
D1	Φ 50Min	Φ 1.97Min
D2	Φ 13±0.5	0.512±0.020
W1	16.8±2.0	0.661±0.079

Outline	Reel (PCS)	Per Carton (PCS)	Reel Diameter (mm)	Carton Size(mm)		
				L	W	H
TAPING	1,000	16,000	330	360	360	380