

SMD Power Inductor

CD75/T125



Description

- Ferrite drum core construction
- Magnetically unshielded.
- LxWxH: 8.1x7.3x5.5mm Max.
- Product weight: 0.76g(Ref.)
- Moisture Sensitivity Level: 1
- Qualification to AEC-Q200



Environmental Data

- Operating Temperature: -40°C to +125°C (including self-heating)
- Storage temperature range: -40°C~+125°C

Packaging

- Carrier tape and reel packaging

Applications

- High temp and high reliability automotive applications

Dimension - [mm]

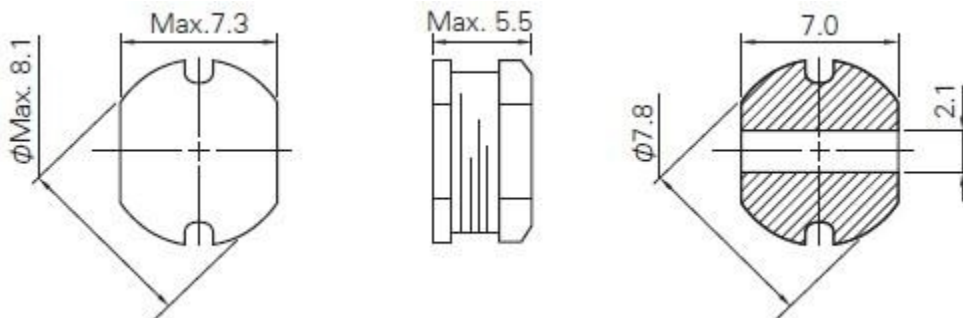

Recommended Land pattern - [mm]

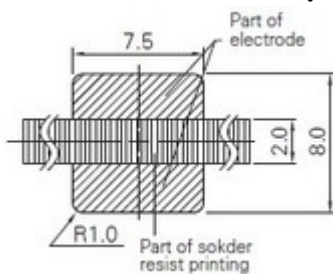

Wire Connection

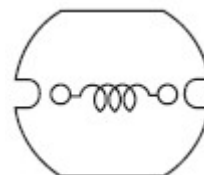

SMD Power Inductor

CD75/T125



Electrical Characteristics

Part Number	Inductance [Within] (μ H) ※1	D.C.R. at 20°C Max.(Typ.) (m Ω)	Saturation Current (A) Max.(Typ.) ※2	Temperature Rise Current (A) Max.(Typ.) ※3
CD75T125NP-100KC	10.00 \pm 10%	70.00 (42.00)	2.24 (2.80)	2.80 (3.18)
CD75T125NP-120KC	12.00 \pm 10%	80.00 (48.00)	1.96 (2.45)	2.78 (3.15)
CD75T125NP-150KC	15.00 \pm 10%	90.00 (56.00)	1.73 (2.16)	2.67 (3.02)
CD75T125NP-180KC	18.00 \pm 10%	100 (63.00)	1.60 (2.00)	2.45 (2.80)
CD75T125NP-220KC	22.00 \pm 10%	110 (70.00)	1.44 (1.80)	2.32 (2.63)
CD75T125NP-270KC	27.00 \pm 10%	120 (82.00)	1.33 (1.66)	2.16 (2.46)
CD75T125NP-330KC	33.00 \pm 10%	130 (97.00)	1.21 (1.51)	2.07 (2.35)
CD75T125NP-390KC	39.00 \pm 10%	160 (117)	1.11 (1.39)	1.80 (2.05)
CD75T125NP-470KC	47.00 \pm 10%	180 (127)	1.01 (1.26)	1.71 (1.95)
CD75T125NP-560KC	56.00 \pm 10%	240 (173)	0.98 (1.22)	1.52 (1.72)
CD75T125NP-680KC	68.00 \pm 10%	280 (207)	0.85 (1.06)	1.29 (1.48)
CD75T125NP-820KC	82.00 \pm 10%	370 (268)	0.76 (0.95)	1.18 (1.34)
CD75T125NP-101KC	100 \pm 10%	430 (360)	0.72 (0.90)	1.14 (1.29)
CD75T125NP-121KC	120 \pm 10%	470 (337)	0.70 (0.87)	1.02 (1.17)
CD75T125NP-151KC	150 \pm 10%	640 (480)	0.58 (0.73)	0.87 (0.96)
CD75T125NP-181KC	180 \pm 10%	710 (550)	0.50 (0.63)	0.81 (0.93)
CD75T125NP-221KC	220 \pm 10%	960 (710)	0.49 (0.61)	0.70 (0.80)
CD75T125NP-271KC	270 \pm 10%	1110 (810)	0.43 (0.54)	0.64 (0.74)
CD75T125NP-331KC	330 \pm 10%	1260 (930)	0.41 (0.51)	0.63 (0.72)
CD75T125NP-391KC	390 \pm 10%	1770 (1220)	0.38 (0.47)	0.54 (0.64)
CD75T125NP-471KC	470 \pm 10%	1960 (1370)	0.34 (0.43)	0.52 (0.60)

※1 Measuring frequency 10 μ H ~ 82 μ H at 2.52 MHz; 100 μ H ~ 820 μ H at 1 kHz

※2 Saturation current: This indicates the actual value of D.C. current when the inductance becomes 10% lower than its initial value.(Ta=20°C)

※3 Temperature rise current: The actual value of D.C. current when the temperature of coil becomes Δ T=40°C (Ta=20°C).

SMD Power Inductor CD75/T125



Solder Reflow Condition

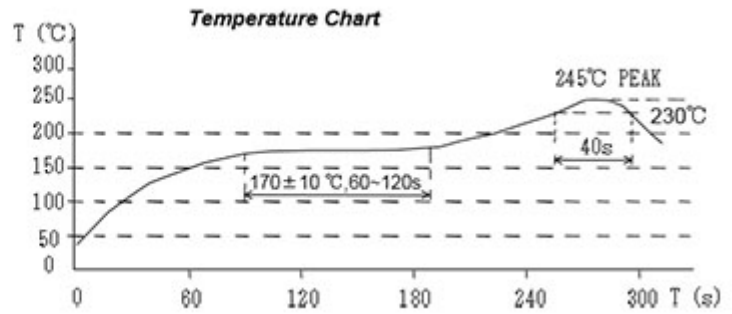
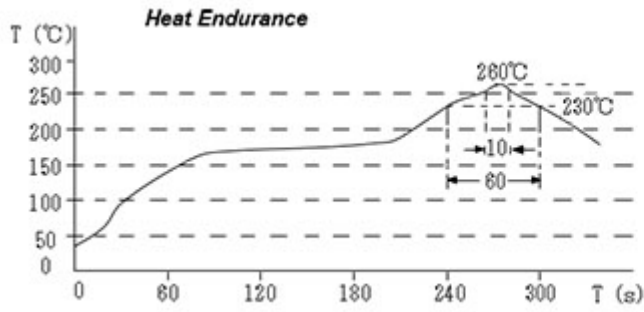

SMD Power Inductor

CD75/T125



Saturation Current & Temperature Rise Graph

— L (20°C) — L (105°C) — ΔT

1. CD75T125NP-100KC

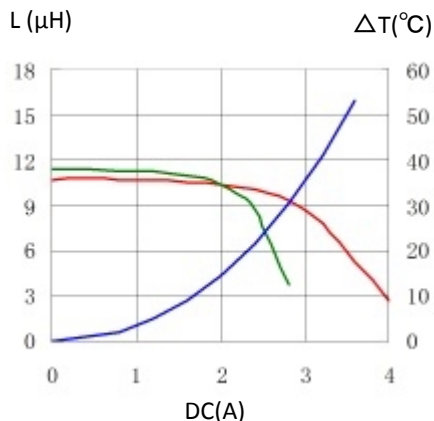

2. CD75T125NP-120KC

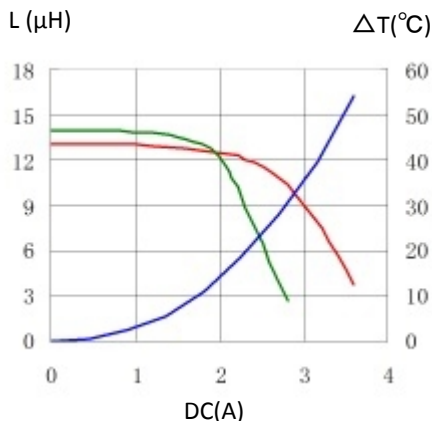

3. CD75T125NP-150KC

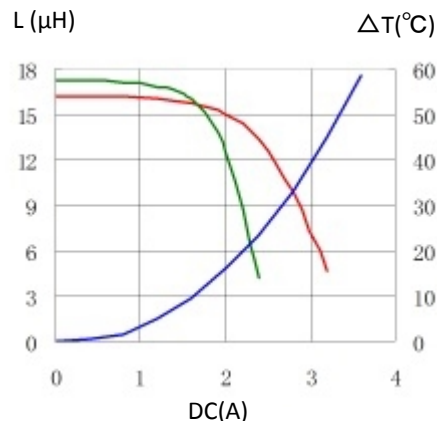

4. CD75T125NP-180KC

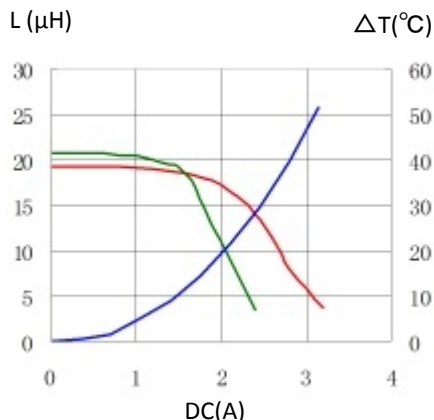

5. CD75T125NP-220KC

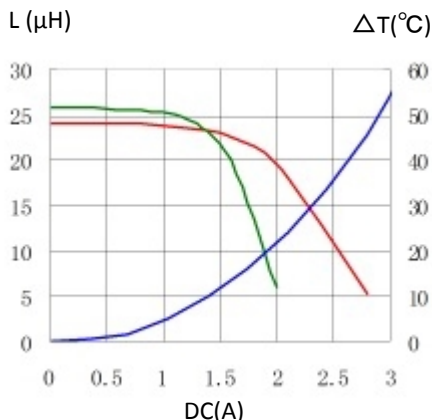

6. CD75T125NP-270KC

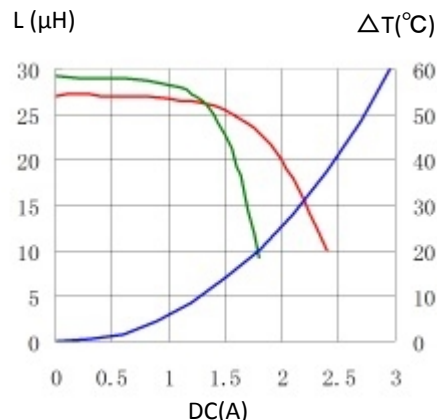

7. CD75T125NP-330KC

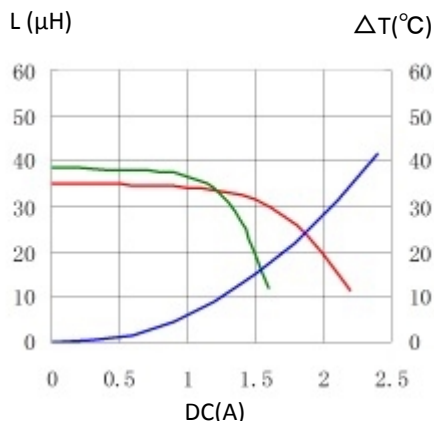

8. CD75T125NP-390KC

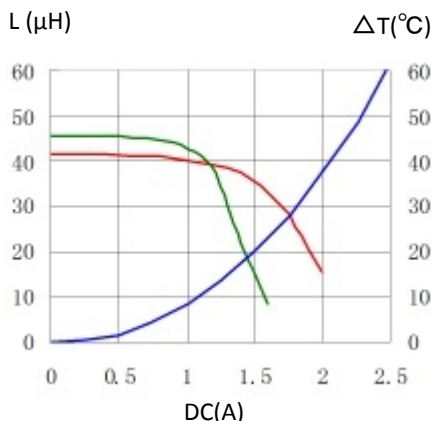

9. CD75T125NP-470KC

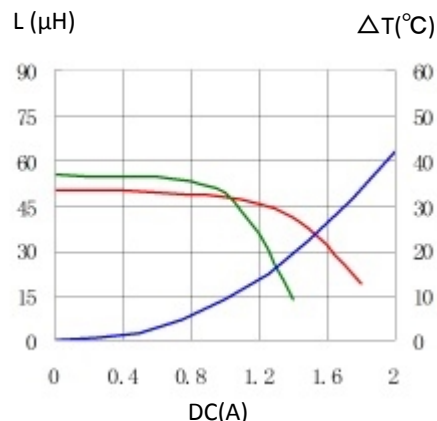

Note: This specification is subject to change without notice. Please contact your nearest sales office for updated information when placing an order.

SMD Power Inductor

CD75/T125



10. CD75T125NP-560KC

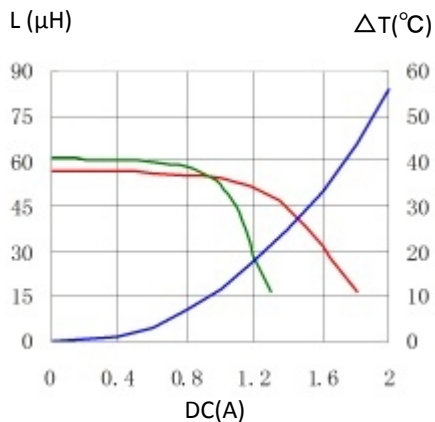

11. CD75T125NP-680KC

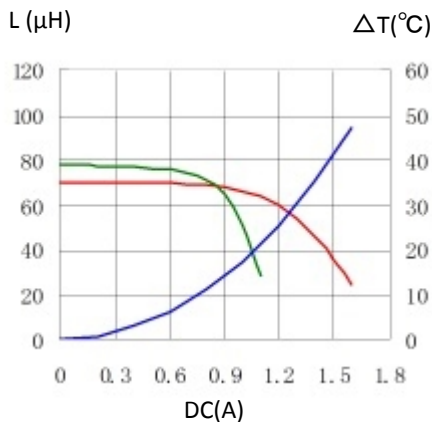

12. CD75T125NP-820KC

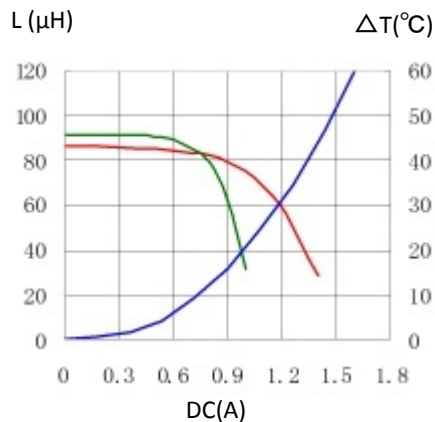

13. CD75T125NP-101KC

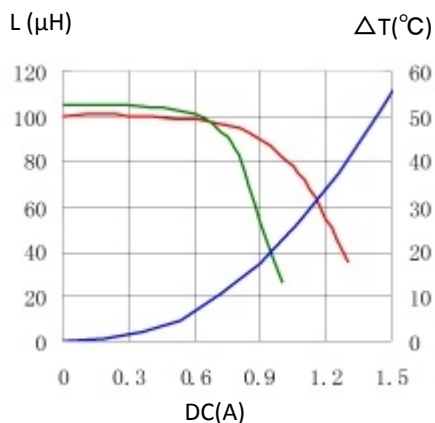

14. CD75T125NP-121KC

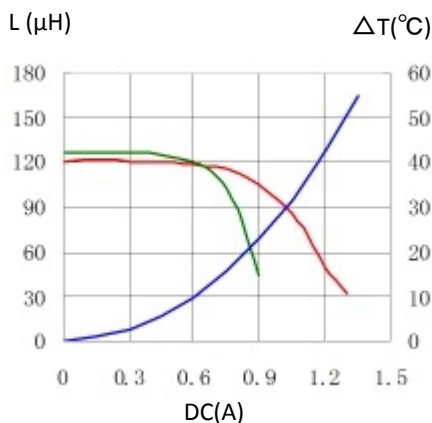

15. CD75T125NP-151KC

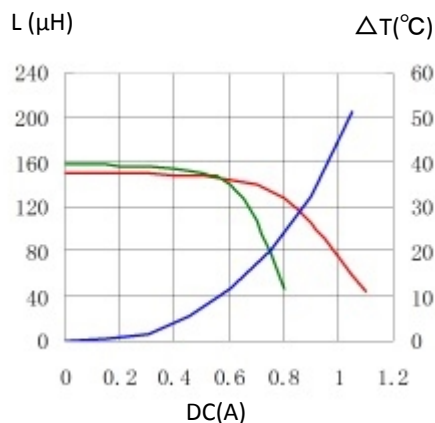

16. CD75T125NP-181KC

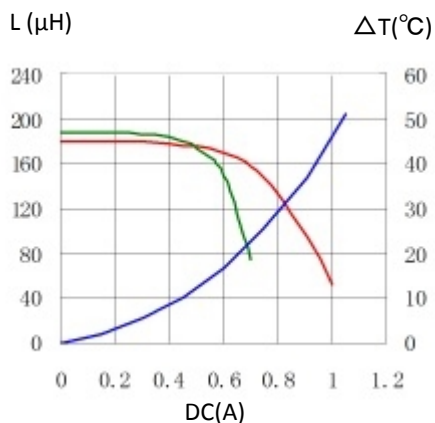

17. CD75T125NP-221KC

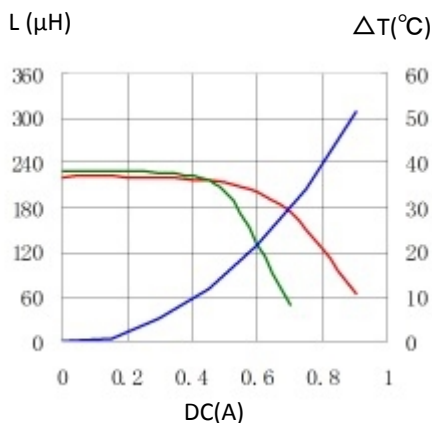

18. CD75T125NP-271KC

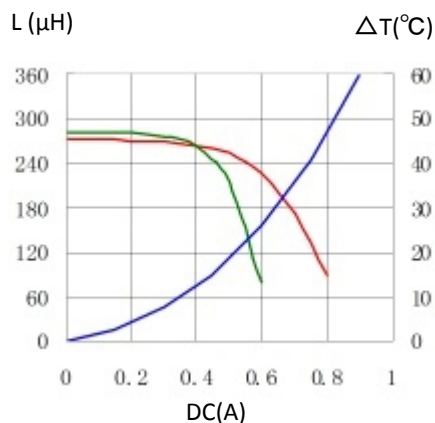

SMD Power Inductor

CD75/T125



19. CD75T125NP-331KC

20. CD75T125NP-391KC

21. CD75T125NP-471KC

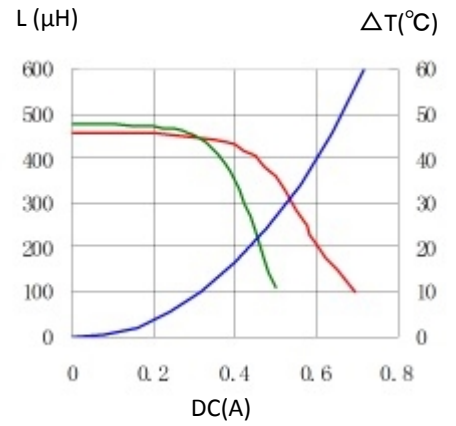
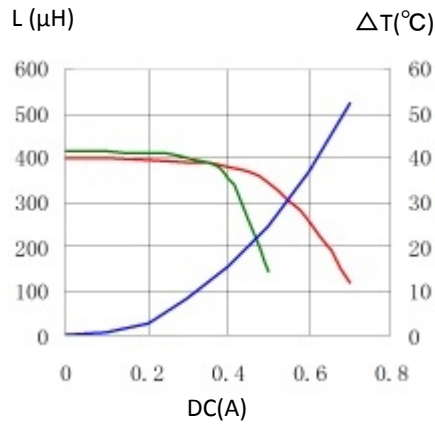
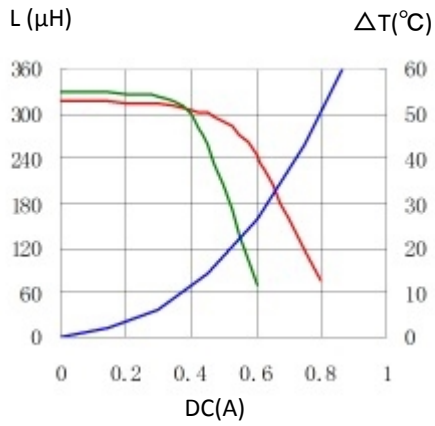

For sales office information, please [click here](#) to visit our website.