

High Power LED Series 3535 Ceramic Hot Binning

LH351D

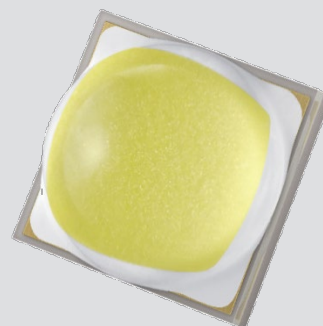

High efficacy and high quality color rendering makes the LH351D suitable use in a broad range of applications

Features & Benefits

- Operates at a maximum current of up to 3.0 A
- Uniform light distribution under any beam angle
- 90 CRI makes it well suited for most applications
- Hot binning @ 85 °C

Applications

- Indoor Lighting: Spotlight, Downlight
- Outdoor Lighting: Street Light, Tunnel Light, Security Light, Area Light, Stadium/Arena Light
- Industrial Lighting: High Bay Light, Low Bay Light
- Consumer Lighting: Torch Light



Table of Contents

| | | | |
|-----|-------------------------------------|-------|----|
| 1. | Characteristics | ----- | 3 |
| 2. | Product Code Information | ----- | 6 |
| 3. | Typical Characteristics Graphs | ----- | 15 |
| 4. | Outline Drawing & Dimension | ----- | 15 |
| 5. | Reliability Test Items & Conditions | ----- | 16 |
| 6. | Soldering Conditions | ----- | 19 |
| 7. | Tape & Reel | ----- | 20 |
| 8. | Label Structure | ----- | 22 |
| 9. | Packing Structure | ----- | 23 |
| 10. | Precautions in Handling & Use | ----- | 25 |

1. Characteristics

a) Absolute Maximum Rating

| Item | Symbol | Rating | Unit | Condition |
|------------------------------|-----------|------------|---------|----------------------------|
| Operating Temperature | T_{opr} | -40 ~ +105 | °C | Note 1)* |
| Storage Temperature | T_{stg} | -40 ~ +120 | °C | - |
| LED Junction Temperature | T_j | 150 | °C | Note 1)* |
| Forward Current | I_F | 3000 | mA | - |
| Peak Pulse Forward Current | I_{FP} | 5000 | mA | Duty 1/10 pulse width 10ms |
| Assembly Process Temperature | | 260 <10 | °C s | - |
| ESD (HBM) | - | ±8 | kV | - |

Notes:

- 1) Refer to the derating curve, '3. Typical Characteristics Graph', for proper driving current that maintained below maximum junction temperature.

b) Electro-optical Characteristics

| Item | Unit | Condition | | | Value | |
|--|------|---------------------|---------------------|-----|-------|------|
| | | I _F (mA) | T _J (°C) | Min | Typ | Max |
| Forward Voltage | V | 1050 | 85 | 2.6 | | 3.2 |
| Reverse Voltage (@ 5 mA) | V | | 25 | 14 | | 19.5 |
| Thermal Resistance (junction to solder point) | °C/W | | 25 | | 2.2 | |
| Beam Angle | ° | 1050 | 25 | | 128 | |

Notes:

- 1) Samsung maintains measurement tolerance of: luminous flux = $\pm 7\%$, forward voltage = ± 0.1 V
- 2) Characteristics @ 25 °C are for reference only

c) Luminous Flux Characteristics (T_j = 85 °C)

| Sorting @ 1050 mA (lm) | | | Calculated Minimum Flux ²⁾ (lm) | | | | | |
|------------------------|--------------------------|------------|--|----------|-----------|-----------|-----------|-----------|
| Flux Rank | Flux Range ¹⁾ | Sub Rank | @ 350 mA | @ 700 mA | @ 1050 mA | @ 1500 mA | @ 2000 mA | @ 3000 mA |
| K6 | 260 ~ 320 | K2, M2, N2 | 96 | 182 | 260 | 351 | 440 | 584 |
| M6 | 280 ~ 340 | M2, N2, P2 | 103 | 196 | 280 | 378 | 474 | 629 |
| N6 | 300 ~ 360 | N2, P2, Q2 | 111 | 210 | 300 | 405 | 507 | 674 |
| P6 | 320 ~ 380 | P2, Q2, R2 | 118 | 224 | 320 | 432 | 541 | 719 |
| Q6 | 340 ~ 400 | Q2, R2, S2 | 126 | 238 | 340 | 459 | 575 | 764 |
| R6 | 360 ~ 420 | R2, S2, T2 | 133 | 252 | 360 | 486 | 609 | 809 |
| S6 | 380 ~ 440 | S2, T2, U2 | 140 | 266 | 380 | 513 | 643 | 854 |
| T6 | 400 ~ 460 | T2, U2, V2 | 148 | 280 | 400 | 540 | 677 | 899 |
| U6 | 420 ~ 480 | U2, V2, W2 | 155 | 294 | 420 | 567 | 710 | 944 |
| V6 | 440 ~ 500 | V2, W2, Y2 | 163 | 308 | 440 | 593 | 744 | 989 |
| W6 | 460 ~ 520 | W2, Y2, Z2 | 170 | 322 | 460 | 620 | 778 | 1,034 |
| Y6 | 480 ~ 540 | Y2, Z2, 12 | 177 | 336 | 480 | 647 | 812 | 1,079 |
| Z6 | 500 ~ 560 | Z2, 12, 22 | 185 | 350 | 500 | 674 | 846 | 1,123 |
| 16 | 520 ~ 580 | 12, 22, 32 | 192 | 364 | 520 | 701 | 879 | 1,168 |
| 26 | 540 ~ 600 | 22, 32, 42 | 200 | 378 | 540 | 728 | 913 | 1,213 |
| 36 | 560 ~ 620 | 32, 42, 52 | 207 | 392 | 560 | 755 | 947 | 1,258 |
| 46 | 580 ~ 640 | 42, 52, 62 | 214 | 406 | 580 | 782 | 981 | 1,303 |
| 56 | 600 ~ 660 | 52, 62, 72 | 222 | 420 | 600 | 809 | 1,015 | 1,348 |
| 66 | 620 ~ 680 | 62, 72, 82 | 229 | 434 | 620 | 836 | 1,049 | 1,393 |
| 76 | 640 ~ 700 | 72, 82, 92 | 237 | 448 | 640 | 863 | 1,082 | 1,438 |
| 86 | 660 ~ 720 | 82, 92 ~ | 244 | 462 | 660 | 890 | 1,116 | 1,483 |
| 96 | 680 ~ 740 | 92 ~ | 251 | 476 | 680 | 917 | 1,150 | 1,528 |

Notes:

- 1) Samsung maintains measurement tolerance of: luminous flux = ±7 %, CRI = ±3
- 2) Calculated minimum flux values are for reference only

2. Product Code Information

| | | | | | | | | | | | | | | | | | |
|---|---|---|---|---|---|---|---|---|----|----|----|----|----|----|----|----|----|
| 1 | 2 | 3 | 4 | 5 | 6 | 7 | 8 | 9 | 10 | 11 | 12 | 13 | 14 | 15 | 16 | 17 | 18 |
| S | P | H | W | H | T | L | 3 | D | A | 0 | C | F | 4 | R | T | U | 6 |

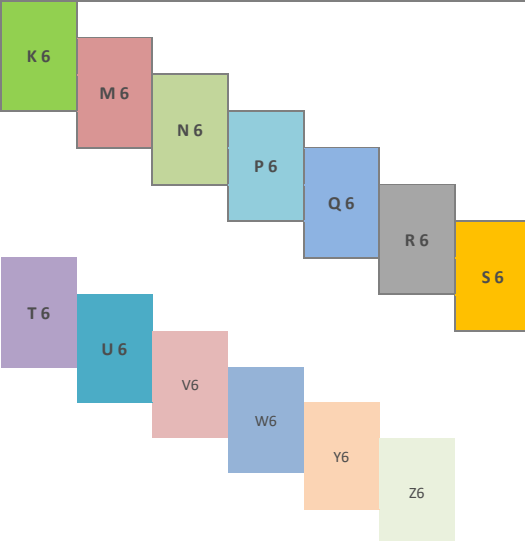
| Digit | PKG Information | Code | Specification |
|-------|----------------------------|---|--|
| 1 2 3 | Samsung Package High Power | SPH | |
| 4 5 | Color | WH | White |
| 6 | Product Version | T | |
| 7 8 | Product | L3 | LH351 Series |
| 9 | Lens Type | D | Dome lens |
| 10 | Internal Code | A | LH351D |
| 11 | Not Defined | 0 | Default |
| 12 | CRI & Sorting Temperature | C E G | Min. 70 Min. 80 85 °C Min. 90 |
| 13 14 | Forward Voltage (V) | F 4 | 2.6~3.2 Bin Code: D2 2.6~2.8 F2 2.8~3.0 H2 3.0~3.2 |
| 15 16 | CCT (K) | W★ V★ U★ T★ R◇ Q R Q◇ P Q P◇ | 2700 W1, W2, W3, W4, W5, W6, W7, W8, W9, WA, WB, WC, WD, WE, WF, WG, WM 3000 V1, V2, V3, V4, V5, V6, V7, V8, V9, VA, VB, VC, VD, VE, VF, VG, VM 3500 U1, U2, U3, U4, U5, U6, U7, U8, U9, UA, UB, UC, UD, UE, UF, UG, UM 4000 T1, T2, T3, T4, T5, T6, T7, T8, T9, TA, TB, TC, TD, TE, TF, TG, TM 5000 Bin Code: R1, R2, R3, R4, RN 5300 Q2, Q4, R1, R3 5700 Q1, Q2, Q3, Q4, QN 6000 P2, P4, Q1, Q3 6500 P1, P2, P3, P4, PN ★ : "0" (Whole bin), "P" (Quarter bin), or "M" (MacAdam 3-step ellipse bin) ◇ : "T" (Half bin), "N" (MacAdam 5-step ellipse bin) |
| 17 18 | Luminous Flux (lm) | K 6 M 6 N 6 P 6 Q 6 R 6 S 6 T 6 U 6 V 6 W 6 Y 6 Z 6 | 260~320 K2 260~280 280~340 M2 280~ 300 300~360 N2 300~320 320~380 P2 320~340 340~400 Q2 340~360 360~420 R2 360~380 380~440 S2 380~400 400~460 T2 400~420 420~480 U2 420~440 440~500 V2 440~460 460~520 W2 460~480 480~540 Y2 480~500 500~560 Z2 500~520  Digit 17: Min. spec. Digit 18: The number of higher bin(s) from min. spec. e.g.: K2 = 260~280 lm, K6 = 260~320 lm |

a) Luminous Flux Bins ($I_f = 1050 \text{ mA}$, $T_j = 85 \text{ }^\circ\text{C}$)

| CRI/ Nominal CCT (K) | Flux rank | | | | | | | | | | | | |
|-------------------------|-----------|-----|-----|-----|-----|-----|---------------------|---------------------|---------------------|---------------------|-----|-----|--|
| | P2 | Q2 | R2 | S2 | T2 | U2 | V2 | W2 | Y2 | Z2 | 12 | 22 | |
| (min. flux) | 320 | 340 | 360 | 380 | 400 | 420 | 440 | 460 | 480 | 500 | 520 | 540 | |
| 70 | 2700 | | | | | | SPHWHTL3DA0CF4W ☆U6 | | | | | | |
| | | | | | | | SPHWHTL3DA0CF4W ☆V6 | | | | | | |
| | 3000 | | | | | | | SPHWHTL3DA0CF4V ☆W6 | | | | | |
| | | | | | | | | | SPHWHTL3DA0CF4V ☆Y6 | | | | |
| | 3500 | | | | | | | SPHWHTL3DA0CF4U ☆W6 | | | | | |
| | | | | | | | | | SPHWHTL3DA0CF4T ☆Y6 | | | | |
| | 4000 | | | | | | | | SPHWHTL3DA0CF4R ◇Y6 | | | | |
| | | | | | | | | | | SPHWHTL3DA0CF4R ◇Z6 | | | |
| 5000 | | | | | | | | SPHWHTL3DA0CF4Q ◇Y6 | | | | | |
| 5700 | | | | | | | | SPHWHTL3DA0CF4P ◇Y6 | | | | | |
| 6500 | | | | | | | | SPHWHTL3DA0CF4P ◇Y6 | | | | | |

"☆" can be "0" (Whole bin), "P" (Quarter bin), or "M" (MacAdam 3-step ellipse bin) of the color binning

"◇" can be "T" (Half bin), "N" (MacAdam 5-step ellipse bin) of the color binning

a) Luminous Flux Bins ($I_f = 1050 \text{ mA}$, $T_j = 85 \text{ }^\circ\text{C}$)

| CRI/ Nominal CCT (K) | Flux rank | | | | | | | | | | | | | |
|-------------------------|-------------|-----|-----|-----|-----|-----|-----|-----|---------------------|---------------------|---------------------|-----|-----|--|
| | K2 | M2 | N2 | P2 | Q2 | R2 | S2 | T2 | U2 | V2 | W2 | Y2 | | |
| | (min. flux) | 260 | 280 | 300 | 320 | 340 | 360 | 380 | 400 | 420 | 440 | 460 | 480 | |
| 80 | 2700 | | | | | | | | SPHWHTL3DA0EF4W ☆S6 | | | | | |
| | 3000 | | | | | | | | SPHWHTL3DA0EF4W ☆T6 | | | | | |
| | | | | | | | | | | SPHWHTL3DA0EF4V ☆T6 | | | | |
| | 3500 | | | | | | | | | SPHWHTL3DA0EF4V ☆U6 | | | | |
| | | | | | | | | | | SPHWHTL3DA0EF4U ☆T6 | | | | |
| | 4000 | | | | | | | | | SPHWHTL3DA0EF4U ☆U6 | | | | |
| | | | | | | | | | | SPHWHTL3DA0EF4T ☆U6 | | | | |
| | 5000 | | | | | | | | | | SPHWHTL3DA0EF4T ☆V6 | | | |
| | | | | | | | | | | | SPHWHTL3DA0EF4R ◇U6 | | | |
| | 5300 | | | | | | | | | | SPHWHTL3DA0EF4R ◇V6 | | | |
| | | | | | | | | | | | SPHWHTL3DA0EF4QRU6 | | | |
| | 5700 | | | | | | | | | | SPHWHTL3DA0EF4QRV6 | | | |
| | | | | | | | | | | | SPHWHTL3DA0EF4Q ◇U6 | | | |
| | 6000 | | | | | | | | | | SPHWHTL3DA0EF4Q ◇V6 | | | |
| | | | | | | | | | | SPHWHTL3DA0EF4PQU6 | | | | |
| 6500 | | | | | | | | | | SPHWHTL3DA0EF4PQV6 | | | | |
| | | | | | | | | | | SPHWHTL3DA0EF4P ◇U6 | | | | |
| | | | | | | | | | | SPHWHTL3DA0EF4P ◇V6 | | | | |

"☆" can be "0" (Whole bin), "P" (Quarter bin), or "M" (MacAdam 3-step ellipse bin) of the color binning

"◇" can be "T" (Half bin), "N" (MacAdam 5-step ellipse bin) of the color binning

a) Luminous Flux Bins (I_f = 1050 mA, T_j = 85 °C)

| CRI/ Nominal CCT (K) | Flux rank | | | | | | | | | | | | |
|-------------------------|-------------|-----|---------------------|-----|-----|--------------------|---------------------|-----|-----|-----|-----|-----|-----|
| | K2 | M2 | N2 | P2 | Q2 | R2 | S2 | T2 | U2 | V2 | W2 | Y2 | |
| | (min. flux) | 260 | 280 | 300 | 320 | 340 | 360 | 380 | 400 | 420 | 440 | 460 | 480 |
| 90 | 2700 | | SPHWHTL3DA0GF4W ☆M6 | | | | | | | | | | |
| | | | SPHWHTL3DA0GF4W ☆N6 | | | | | | | | | | |
| | 3000 | | SPHWHTL3DA0GF4V ☆N6 | | | | | | | | | | |
| | | | SPHWHTL3DA0GF4V ☆P6 | | | | | | | | | | |
| | 3500 | | SPHWHTL3DA0GF4U ☆N6 | | | | | | | | | | |
| | | | SPHWHTL3DA0GF4U ☆P6 | | | | | | | | | | |
| | 4000 | | SPHWHTL3DA0GF4T ☆P6 | | | | | | | | | | |
| | | | SPHWHTL3DA0GF4T ☆Q6 | | | | | | | | | | |
| | 5000 | | | | | | SPHWHTL3DA0GF4R ◇R6 | | | | | | |
| | | | | | | | SPHWHTL3DA0GF4R ◇S6 | | | | | | |
| | 5700 | | | | | | SPHWHTL3DA0GF4Q ◇S6 | | | | | | |
| | 6000 | | | | | | SPHWHTL3DA0GF4PQR6 | | | | | | |
| | | | | | | SPHWHTL3DA0GF4PQS6 | | | | | | | |

"☆" can be "0" (Whole bin), "P" (Quarter bin), or "M" (MacAdam 3-step ellipse bin) of the color binning

"◇" can be "T" (Half bin), "N" (MacAdam 5-step ellipse bin) of the color binning

b) Color Bins ($I_F = 1050 \text{ mA}$, $T_j = 85 \text{ }^\circ\text{C}$)

| Nominal CCT (K) | CRI (R_a) | Color Rank | Chromaticity Bins |
|------------------------|---------------|---------------------|--|
| 2700, 3000, 3500, 4000 | 70, 80, 90 | ☆0 (ANSI bin) | 1, 2, 3, 4, 5, 6, 7, 8, 9, A, B, C, D, E, F, G |
| | | ☆P (Quarter bin) | 6, 7, A, B |
| | | ☆M (MacAdam 3-step) | M |
| 5300 | 80 | ☆T (Half bin) | 1, 2, 3, 4 |
| 6000 | 80, 90 | ☆T (Half bin) | 1, 2, 3, 4 |
| 5700, 6500 | 70, 80 | ☆T (Half bin) | 1, 2, 3, 4 |
| | | ☆N (MacAdam 5-step) | N |
| 5000 | 70, 80, 90 | ☆T (Half bin) | 1, 2, 3, 4 |
| | | ☆N (MacAdam 5-step) | N |

c) Voltage Bins ($I_F = 1050 \text{ mA}$, $T_j = 85 \text{ }^\circ\text{C}$)

| Nominal CCT (K) | CRI (R_a) Min. | Product Code | Voltage Rank | Voltage Bin | Voltage Range (V) |
|-----------------|--------------------|--------------|--------------|-------------|-------------------|
| - | - | - | F4 | D2 | 2.6 ~ 2.8 |
| | | | | F2 | 2.8 ~ 3.0 |
| | | | | H2 | 3.0 ~ 3.2 |

d) Chromaticity Region & Coordinates ($I_f = 1050 \text{ mA}$, $T_j = 85 \text{ }^\circ\text{C}$)

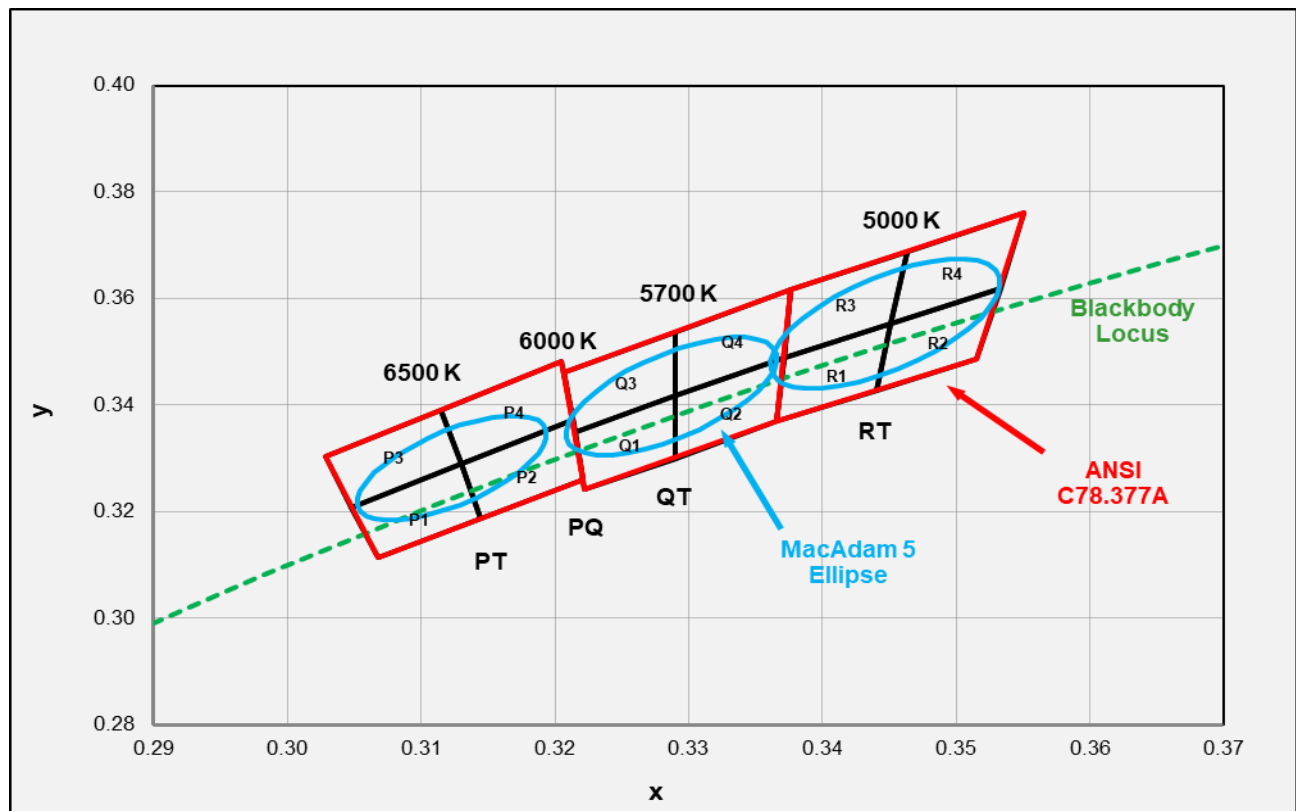
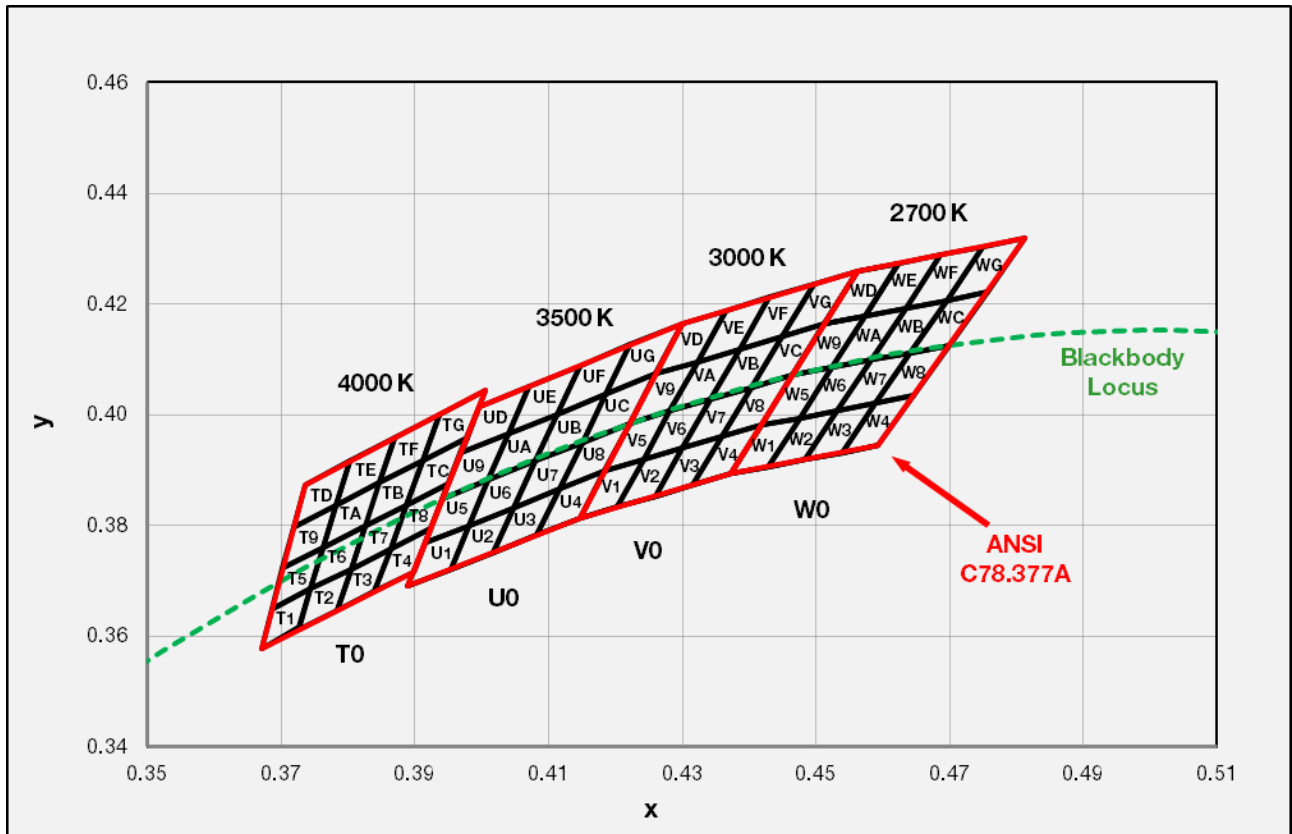

d) Chromaticity Region & Coordinates ($I_f = 1050 \text{ mA}$, $T_j = 85 \text{ }^\circ\text{C}$)

| Region | CIE x | CIE y | Region | CIE x | CIE y |
|------------------------|--------|--------|--------|--------|--------|
| W rank (2700 K) | | | | | |
| W1 | 0.4373 | 0.3893 | W9 | 0.4465 | 0.4071 |
| | 0.4418 | 0.3981 | | 0.4513 | 0.4164 |
| | 0.4475 | 0.3994 | | 0.4573 | 0.4178 |
| | 0.4428 | 0.3906 | | 0.4523 | 0.4085 |
| W2 | 0.4428 | 0.3906 | WA | 0.4523 | 0.4085 |
| | 0.4475 | 0.3994 | | 0.4573 | 0.4178 |
| | 0.4532 | 0.4008 | | 0.4634 | 0.4193 |
| | 0.4483 | 0.3919 | | 0.4582 | 0.4099 |
| W3 | 0.4483 | 0.3919 | WB | 0.4582 | 0.4099 |
| | 0.4532 | 0.4008 | | 0.4634 | 0.4193 |
| | 0.4589 | 0.4021 | | 0.4695 | 0.4207 |
| | 0.4538 | 0.3931 | | 0.4641 | 0.4112 |
| W4 | 0.4538 | 0.3931 | WC | 0.4641 | 0.4112 |
| | 0.4589 | 0.4021 | | 0.4695 | 0.4207 |
| | 0.4646 | 0.4034 | | 0.4756 | 0.4221 |
| | 0.4593 | 0.3944 | | 0.4700 | 0.4126 |
| W5 | 0.4418 | 0.3981 | WD | 0.4513 | 0.4164 |
| | 0.4465 | 0.4071 | | 0.4562 | 0.4260 |
| | 0.4523 | 0.4085 | | 0.4624 | 0.4274 |
| | 0.4475 | 0.3994 | | 0.4573 | 0.4178 |
| W6 | 0.4475 | 0.3994 | WE | 0.4573 | 0.4178 |
| | 0.4523 | 0.4085 | | 0.4624 | 0.4274 |
| | 0.4582 | 0.4099 | | 0.4687 | 0.4289 |
| | 0.4532 | 0.4008 | | 0.4634 | 0.4193 |
| W7 | 0.4532 | 0.4008 | WF | 0.4634 | 0.4193 |
| | 0.4582 | 0.4099 | | 0.4687 | 0.4289 |
| | 0.4641 | 0.4112 | | 0.4750 | 0.4304 |
| | 0.4589 | 0.4021 | | 0.4695 | 0.4207 |
| W8 | 0.4589 | 0.4021 | WG | 0.4695 | 0.4207 |
| | 0.4641 | 0.4112 | | 0.4750 | 0.4304 |
| | 0.4700 | 0.4126 | | 0.4813 | 0.4319 |
| | 0.4646 | 0.4034 | | 0.4756 | 0.4221 |

| Region | CIE x | CIE y | Region | CIE x | CIE y |
|------------------------|--------|--------|--------|--------|--------|
| V rank (3000 K) | | | | | |
| V1 | 0.4147 | 0.3814 | V9 | 0.4221 | 0.3984 |
| | 0.4183 | 0.3898 | | 0.4259 | 0.4073 |
| | 0.4242 | 0.3919 | | 0.4322 | 0.4096 |
| | 0.4203 | 0.3833 | | 0.4281 | 0.4006 |
| V2 | 0.4203 | 0.3833 | VA | 0.4281 | 0.4006 |
| | 0.4242 | 0.3919 | | 0.4322 | 0.4096 |
| | 0.4300 | 0.3939 | | 0.4385 | 0.4119 |
| | 0.4259 | 0.3853 | | 0.4342 | 0.4028 |
| V3 | 0.4259 | 0.3853 | VB | 0.4342 | 0.4028 |
| | 0.4300 | 0.3939 | | 0.4385 | 0.4119 |
| | 0.4359 | 0.3960 | | 0.4449 | 0.4141 |
| | 0.4316 | 0.3873 | | 0.4403 | 0.4049 |
| V4 | 0.4316 | 0.3873 | VC | 0.4403 | 0.4049 |
| | 0.4359 | 0.3960 | | 0.4449 | 0.4141 |
| | 0.4418 | 0.3981 | | 0.4513 | 0.4164 |
| | 0.4373 | 0.3893 | | 0.4465 | 0.4071 |
| V5 | 0.4183 | 0.3898 | VD | 0.4259 | 0.4073 |
| | 0.4221 | 0.3984 | | 0.4299 | 0.4165 |
| | 0.4281 | 0.4006 | | 0.4364 | 0.4188 |
| | 0.4242 | 0.3919 | | 0.4322 | 0.4096 |
| V6 | 0.4242 | 0.3919 | VE | 0.4322 | 0.4096 |
| | 0.4281 | 0.4006 | | 0.4364 | 0.4188 |
| | 0.4342 | 0.4028 | | 0.4430 | 0.4212 |
| | 0.4300 | 0.3939 | | 0.4385 | 0.4119 |
| V7 | 0.4300 | 0.3939 | VF | 0.4385 | 0.4119 |
| | 0.4342 | 0.4028 | | 0.4430 | 0.4212 |
| | 0.4403 | 0.4049 | | 0.4496 | 0.4236 |
| | 0.4359 | 0.3960 | | 0.4449 | 0.4141 |
| V8 | 0.4359 | 0.3960 | VG | 0.4449 | 0.4141 |
| | 0.4403 | 0.4049 | | 0.4496 | 0.4236 |
| | 0.4465 | 0.4071 | | 0.4562 | 0.4260 |
| | 0.4418 | 0.3981 | | 0.4513 | 0.4164 |

d) Chromaticity Region & Coordinates ($I_f = 1050 \text{ mA}$, $T_j = 85 \text{ }^\circ\text{C}$)

| Region | CIE x | CIE y | Region | CIE x | CIE y |
|------------------------|--------|--------|--------|--------|--------|
| U rank (3500 K) | | | | | |
| U1 | 0.3889 | 0.3690 | U9 | 0.3941 | 0.3848 |
| | 0.3915 | 0.3768 | | 0.3968 | 0.3930 |
| | 0.3981 | 0.3800 | | 0.4040 | 0.3966 |
| | 0.3953 | 0.3720 | | 0.4010 | 0.3882 |
| U2 | 0.3953 | 0.3720 | UA | 0.4010 | 0.3882 |
| | 0.3981 | 0.3800 | | 0.4040 | 0.3966 |
| | 0.4048 | 0.3832 | | 0.4113 | 0.4001 |
| | 0.4017 | 0.3751 | | 0.4080 | 0.3916 |
| U3 | 0.4017 | 0.3751 | UB | 0.4080 | 0.3916 |
| | 0.4048 | 0.3832 | | 0.4113 | 0.4001 |
| | 0.4116 | 0.3865 | | 0.4186 | 0.4037 |
| | 0.4082 | 0.3782 | | 0.4150 | 0.3950 |
| U4 | 0.4082 | 0.3782 | UC | 0.4150 | 0.3950 |
| | 0.4116 | 0.3865 | | 0.4186 | 0.4037 |
| | 0.4183 | 0.3898 | | 0.4259 | 0.4073 |
| | 0.4147 | 0.3814 | | 0.4221 | 0.3984 |
| U5 | 0.3915 | 0.3768 | UD | 0.3968 | 0.3930 |
| | 0.3941 | 0.3848 | | 0.3996 | 0.4015 |
| | 0.4010 | 0.3882 | | 0.4071 | 0.4052 |
| | 0.3981 | 0.3800 | | 0.4040 | 0.3966 |
| U6 | 0.3981 | 0.3800 | UE | 0.4040 | 0.3966 |
| | 0.4010 | 0.3882 | | 0.4071 | 0.4052 |
| | 0.4080 | 0.3916 | | 0.4146 | 0.4089 |
| | 0.4048 | 0.3832 | | 0.4113 | 0.4001 |
| U7 | 0.4048 | 0.3832 | UF | 0.4113 | 0.4001 |
| | 0.4080 | 0.3916 | | 0.4146 | 0.4089 |
| | 0.4150 | 0.3950 | | 0.4222 | 0.4127 |
| | 0.4116 | 0.3865 | | 0.4186 | 0.4037 |
| U8 | 0.4116 | 0.3865 | UG | 0.4186 | 0.4037 |
| | 0.4150 | 0.3950 | | 0.4222 | 0.4127 |
| | 0.4221 | 0.3984 | | 0.4299 | 0.4165 |
| | 0.4183 | 0.3898 | | 0.4259 | 0.4073 |

| Region | CIE x | CIE y | Region | CIE x | CIE y |
|------------------------|--------|--------|--------|--------|--------|
| T rank (4000 K) | | | | | |
| T1 | 0.3670 | 0.3578 | T9 | 0.3702 | 0.3722 |
| | 0.3726 | 0.3612 | | 0.3763 | 0.3760 |
| | 0.3744 | 0.3685 | | 0.3782 | 0.3837 |
| | 0.3686 | 0.3649 | | 0.3719 | 0.3797 |
| T2 | 0.3726 | 0.3612 | TA | 0.3763 | 0.3760 |
| | 0.3783 | 0.3646 | | 0.3825 | 0.3798 |
| | 0.3804 | 0.3721 | | 0.3847 | 0.3877 |
| | 0.3744 | 0.3685 | | 0.3782 | 0.3837 |
| T3 | 0.3783 | 0.3646 | TB | 0.3825 | 0.3798 |
| | 0.3840 | 0.3681 | | 0.3887 | 0.3836 |
| | 0.3863 | 0.3758 | | 0.3912 | 0.3917 |
| | 0.3804 | 0.3721 | | 0.3847 | 0.3877 |
| T4 | 0.3840 | 0.3681 | TC | 0.3887 | 0.3837 |
| | 0.3898 | 0.3716 | | 0.3950 | 0.3875 |
| | 0.3924 | 0.3794 | | 0.3978 | 0.3958 |
| | 0.3863 | 0.3758 | | 0.3912 | 0.3917 |
| T5 | 0.3686 | 0.3649 | TD | 0.3719 | 0.3797 |
| | 0.3744 | 0.3685 | | 0.3782 | 0.3837 |
| | 0.3763 | 0.3760 | | 0.3802 | 0.3916 |
| | 0.3702 | 0.3722 | | 0.3736 | 0.3874 |
| T6 | 0.3744 | 0.3685 | TE | 0.3782 | 0.3837 |
| | 0.3804 | 0.3721 | | 0.3847 | 0.3877 |
| | 0.3825 | 0.3798 | | 0.3869 | 0.3958 |
| | 0.3763 | 0.3760 | | 0.3802 | 0.3916 |
| T7 | 0.3804 | 0.3721 | TF | 0.3847 | 0.3877 |
| | 0.3863 | 0.3758 | | 0.3912 | 0.3917 |
| | 0.3887 | 0.3836 | | 0.3937 | 0.4001 |
| | 0.3825 | 0.3798 | | 0.3869 | 0.3958 |
| T8 | 0.3863 | 0.3758 | TG | 0.3912 | 0.3917 |
| | 0.3924 | 0.3794 | | 0.3978 | 0.3958 |
| | 0.3950 | 0.3875 | | 0.4006 | 0.4044 |
| | 0.3887 | 0.3836 | | 0.3937 | 0.4001 |

d) Chromaticity Region & Coordinates

| Region | CIE x | CIE y | Region | CIE x | CIE y | Region | CIE x | CIE y | Region | CIE x | CIE y | Region | CIE x | CIE y | | |
|------------------------|--------|--------|-------------------------|--------|--------|------------------------|--------|--------|-------------------------|--------|--------|------------------------|--------|--------|--------|--------|
| R rank (5000 K) | | | QR rank (5300 K) | | | Q rank (5700 K) | | | PQ rank (6000 K) | | | P rank (6500 K) | | | | |
| R1 | 0.3371 | 0.349 | Q2 | 0.329 | 0.3417 | Q1 | 0.3215 | 0.335 | P2 | 0.3144 | 0.3186 | P1 | 0.3068 | 0.3113 | | |
| | 0.3451 | 0.3554 | | 0.3371 | 0.349 | | 0.329 | 0.3417 | | 0.3221 | 0.3261 | | 0.3144 | 0.3186 | 0.313 | 0.329 |
| | 0.344 | 0.3427 | | 0.3366 | 0.3369 | | 0.329 | 0.33 | | 0.3213 | 0.3373 | | 0.313 | 0.329 | 0.3048 | 0.3207 |
| | 0.3366 | 0.3369 | | 0.329 | 0.33 | | 0.3222 | 0.3243 | | 0.313 | 0.329 | | 0.3215 | 0.335 | 0.3144 | 0.3186 |
| R2 | 0.3451 | 0.3554 | R1 | 0.3371 | 0.349 | Q2 | 0.329 | 0.3417 | Q1 | 0.3215 | 0.335 | P2 | 0.3068 | 0.3113 | | |
| | 0.3533 | 0.362 | | 0.3451 | 0.3554 | | 0.3371 | 0.349 | | 0.329 | 0.3417 | | 0.3221 | 0.3261 | 0.3144 | 0.3186 |
| | 0.3515 | 0.3487 | | 0.344 | 0.3427 | | 0.3366 | 0.3369 | | 0.329 | 0.33 | | 0.3213 | 0.3373 | 0.313 | 0.329 |
| | 0.344 | 0.3427 | | 0.3366 | 0.3369 | | 0.329 | 0.33 | | 0.3222 | 0.3243 | | 0.313 | 0.329 | 0.3048 | 0.3207 |
| R3 | 0.3376 | 0.3616 | Q4 | 0.329 | 0.3538 | Q3 | 0.3207 | 0.3462 | P4 | 0.313 | 0.329 | P3 | 0.3048 | 0.3207 | | |
| | 0.3463 | 0.3687 | | 0.3376 | 0.3616 | | 0.329 | 0.3538 | | 0.3213 | 0.3373 | | 0.313 | 0.329 | 0.313 | 0.329 |
| | 0.3451 | 0.3554 | | 0.3371 | 0.349 | | 0.329 | 0.3417 | | 0.3205 | 0.3481 | | 0.3115 | 0.3391 | 0.3115 | 0.3391 |
| | 0.3371 | 0.349 | | 0.329 | 0.3417 | | 0.3215 | 0.335 | | 0.3115 | 0.3391 | | 0.3028 | 0.3304 | 0.3028 | 0.3304 |
| R4 | 0.3463 | 0.3687 | R3 | 0.3376 | 0.3616 | Q4 | 0.329 | 0.3538 | Q3 | 0.3207 | 0.3462 | P4 | 0.3048 | 0.3207 | | |
| | 0.3551 | 0.376 | | 0.3463 | 0.3687 | | 0.3376 | 0.3616 | | 0.329 | 0.3538 | | 0.3213 | 0.3373 | 0.313 | 0.329 |
| | 0.3533 | 0.362 | | 0.3451 | 0.3554 | | 0.3371 | 0.349 | | 0.329 | 0.3417 | | 0.3205 | 0.3481 | 0.3115 | 0.3391 |
| | 0.3451 | 0.3554 | | 0.3371 | 0.349 | | 0.329 | 0.3417 | | 0.3215 | 0.335 | | 0.3115 | 0.3391 | 0.3028 | 0.3304 |

e) MacAdam Ellipse ($I_f = 1050 \text{ mA}$, $T_j = 85 \text{ }^\circ\text{C}$)

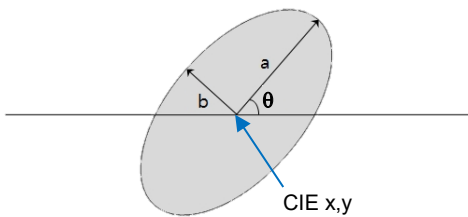

| Nom. CCT (K) | Color Rank | Ellipse | Center | | Rotation Angle θ ($^\circ$) | a | b |
|--------------|------------|---------|--------|--------|--------------------------------------|--------|--------|
| | | | CIE x | CIE y | | | |
| 2200 | YM | 3-step | 0.5018 | 0.4153 | 53.45 | 0.0072 | 0.0040 |
| 2700 | WM | 3-step | 0.4578 | 0.4101 | 53.70 | 0.0081 | 0.0042 |
| 3000 | VM | 3-step | 0.4338 | 0.4030 | 53.22 | 0.0083 | 0.0041 |
| 3500 | UM | 3-step | 0.4073 | 0.3917 | 54.00 | 0.0093 | 0.0041 |
| 4000 | TM | 3-step | 0.3818 | 0.3797 | 53.72 | 0.0094 | 0.0040 |
| 5000 | RN | 5-step | 0.3447 | 0.3553 | 59.62 | 0.0137 | 0.0059 |
| 5700 | QN | 5-step | 0.3287 | 0.3417 | 59.10 | 0.0125 | 0.0053 |
| 6500 | PN | 5-step | 0.3123 | 0.3282 | 58.57 | 0.0116 | 0.0048 |

Note:

Samsung maintains measurement tolerance of: $C_x, C_y = \pm 0.005$

3. Typical Characteristics Graphs

a) Spectrum Distribution ($I_f = 1050 \text{ mA}$, $T_j = 85 \text{ }^\circ\text{C}$)

Cool White (CRI70)

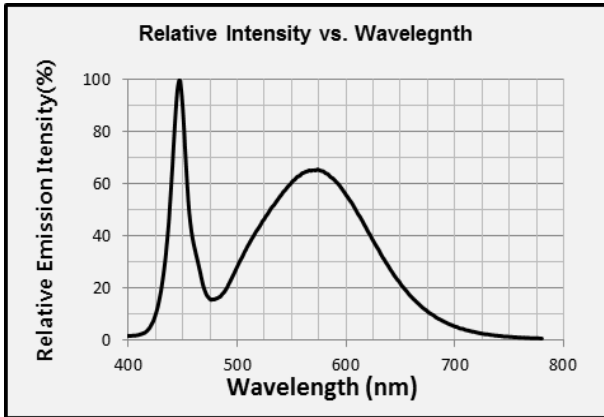

Warm White (CRI80)

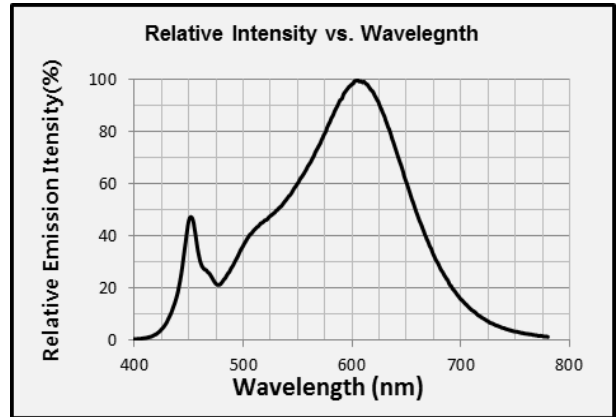

Cool White (CRI90)

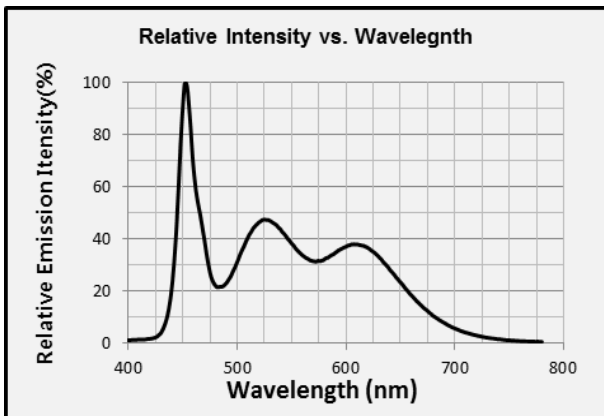

b) Forward Current Characteristics ($T_j = 85 \text{ }^\circ\text{C}$)

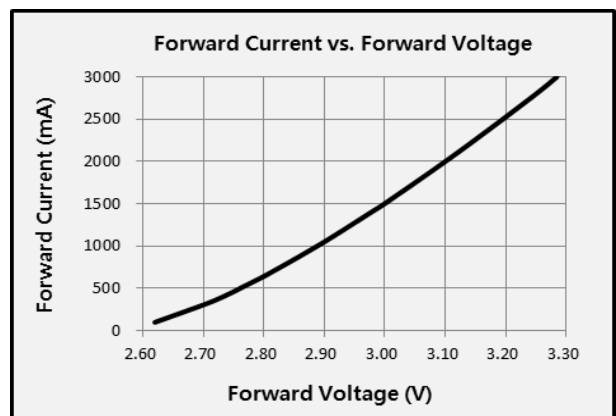
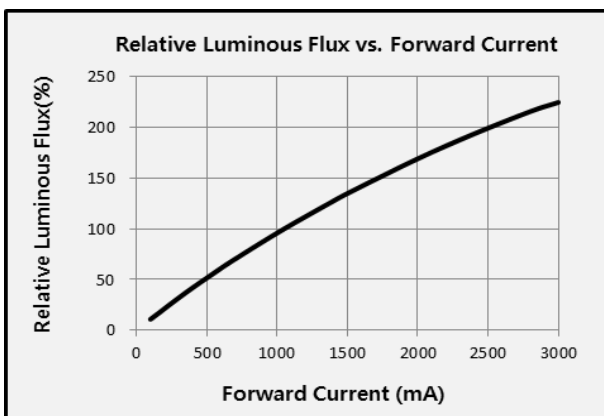

c) Temperature Characteristics ($I_f = 1050 \text{ mA}$)

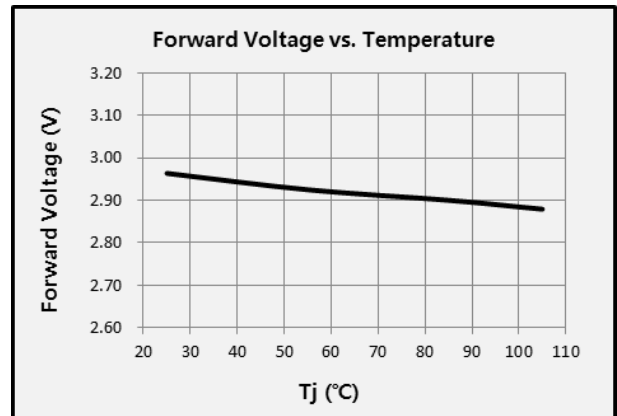
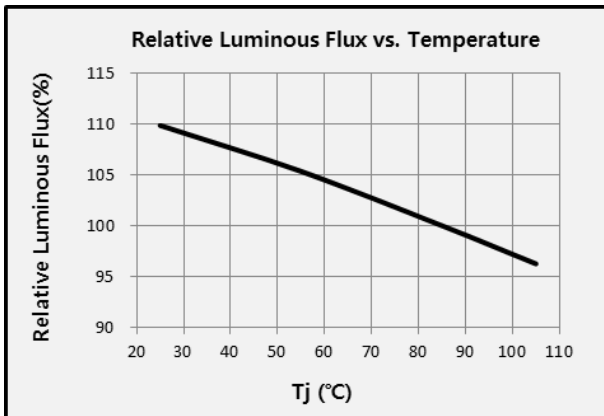

d) Color Shift Characteristics ($I_f = 1050 \text{ mA}$, $T_j = 85 \text{ °C}$)

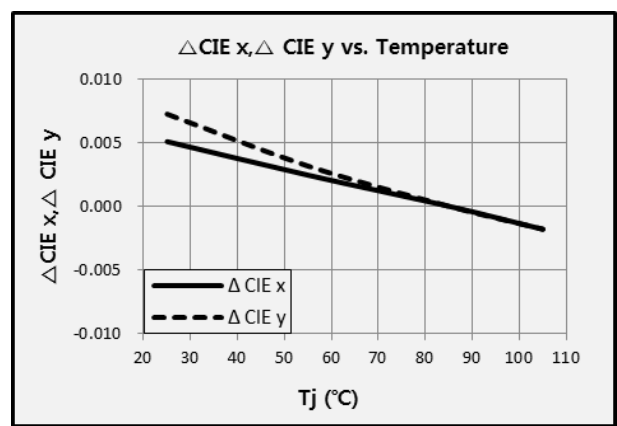
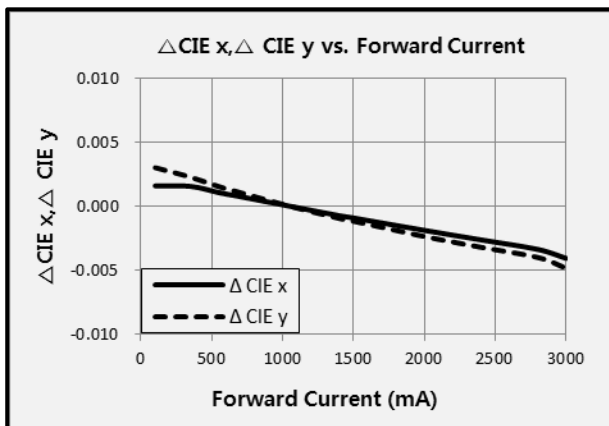

e) Derating Curve and Beam Angle Characteristics ($I_f = 1050 \text{ mA}$, $T_j = 25 \text{ °C}$)

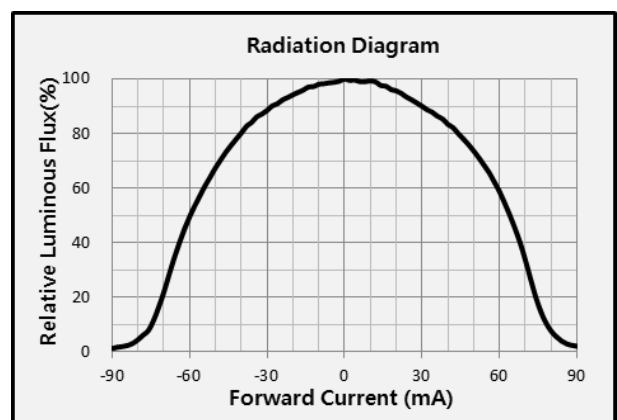
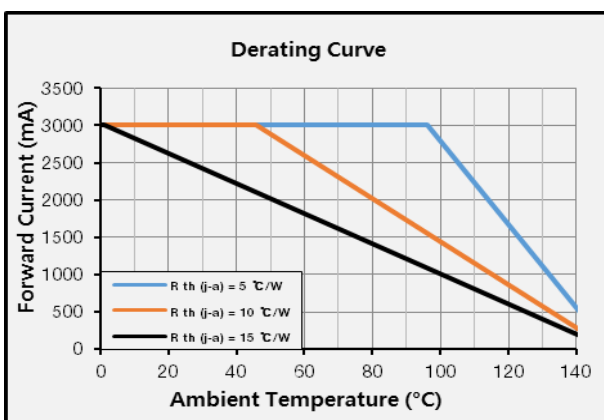

4. Outline Drawing & Dimension

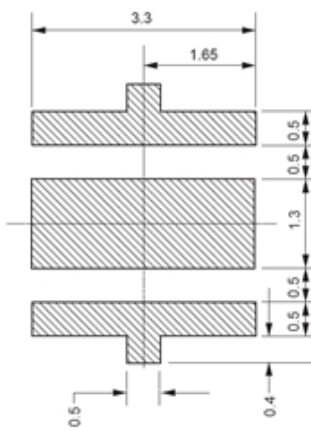
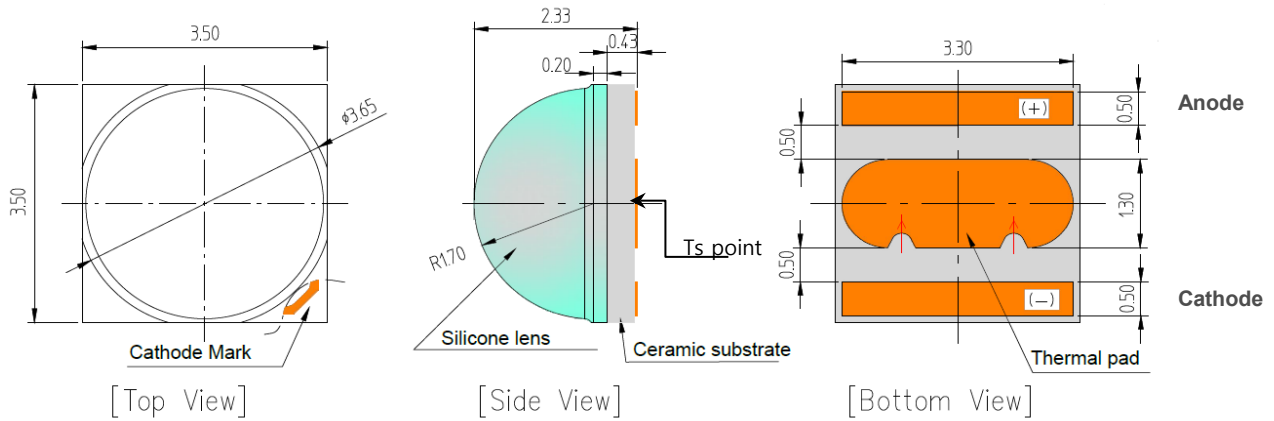

- Measurement unit: mm
- Tolerance: ± 0.13 mm

Recommended Soldering Pattern

Notes:

- 1) This LED has built-in ESD protection device(s) connected in parallel to LED chip(s).
- 2) The thermal pad is electrically isolated from the anode and cathode contact pads.
- 3) T_s point and measurement method:
 - ① Measure the nearest point to thermal pad as shown above. If necessary, remove PSR of PCB to reach T_s point.
 - ② All pads must be soldered to the PCB to dissipate heat properly, otherwise the LED can be damaged.

Precautions:

- 1) Pressure on the LEDs will influence to the reliability of the LEDs. Precautions should be taken to avoid strong pressure on the LEDs. Do not put stress on the LEDs during heating.
- 2) Re-soldering should not be done after the LEDs have been soldered. If re-soldering is unavoidable, LED's characteristics should be carefully checked before and after such repair.
- 3) Do not stack assembled PCBs together. Since materials of LEDs is soft, abrasion between two PCB assembled with LED might cause catastrophic failure of the LEDs.

5. Reliability Test Items & Conditions

a) Test Items

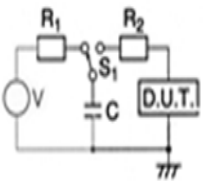
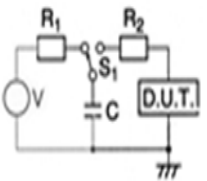
| Test Item | Test Condition | Test Hour / Cycle |
|-------------------------------------|---|-------------------|
| Room Temperature Life Test | 25 °C, Maximum Rated Drive Current | 1000 h |
| High Temperature Life Test | 85 °C, Maximum Rated Drive Current | 1000 h |
| High Temperature Humidity Life Test | 85 °C, 85 % R.H., Maximum Rated Drive Current | 1000 h |
| Low Temperature Life Test | -40 °C, Maximum Rated Drive Current | 1000 h |
| Powered Temperature Cycle | -40 °C / 10 min ↔ 85 °C / 10 min, sweep 20 min cycle on/off: each 5 min, Maximum Rated Drive Current | 1000 h |
| Damp Heat Cycling | -10 °C ↔ 25 °C/Dry ↔ 65 °C /95 % RH , 24 h / 1 cycle | 10 cycles |
| Temperature Cycling | -45 °C / 15 min ↔ 125 °C / 15 min temperature change within 5 min | 500 cycles |
| High Temperature Storage | 120 °C | 1000 h |
| High Temperature Humidity Storage | 85 °C, 85 % R.H. | 1000 h |
| ESD (HBM) |  <p> R_1: 10 MΩ R_2: 1.5 kΩ C: 100 pF V: ± 8 kV </p> | 5 times |
| ESD (MM) |  <p> R_1: 10 MΩ R_2: 0 C: 200 pF V: ± 0.5 kV </p> | 5 times |
| Vibration Test | 20~2000~20 Hz, 200 m/s ² , sweep 4 min X, Y, Z 3 direction, each 1 cycle | 4 cycles |
| Mechanical Shock Test | 1500 g, 0.5 ms 3 shocks each X-Y-Z axis | 5 cycles |

b) Criteria for Judging the Damage

| Item | Symbol | Test Condition ($T_j = 25$ °C) | Limit | |
|-----------------|----------|------------------------------------|-------------------|-------------------|
| | | | Min. | Max. |
| Forward Voltage | V_F | $I_F = 1050$ mA | Init. Value * 0.9 | Init. Value * 1.1 |
| Luminous Flux | Φ_v | $I_F = 1050$ mA | Init. Value * 0.7 | Init. Value * 1.1 |

6. Soldering Conditions

a) Reflow Conditions (Pb free)

Reflow frequency: 2 times max.

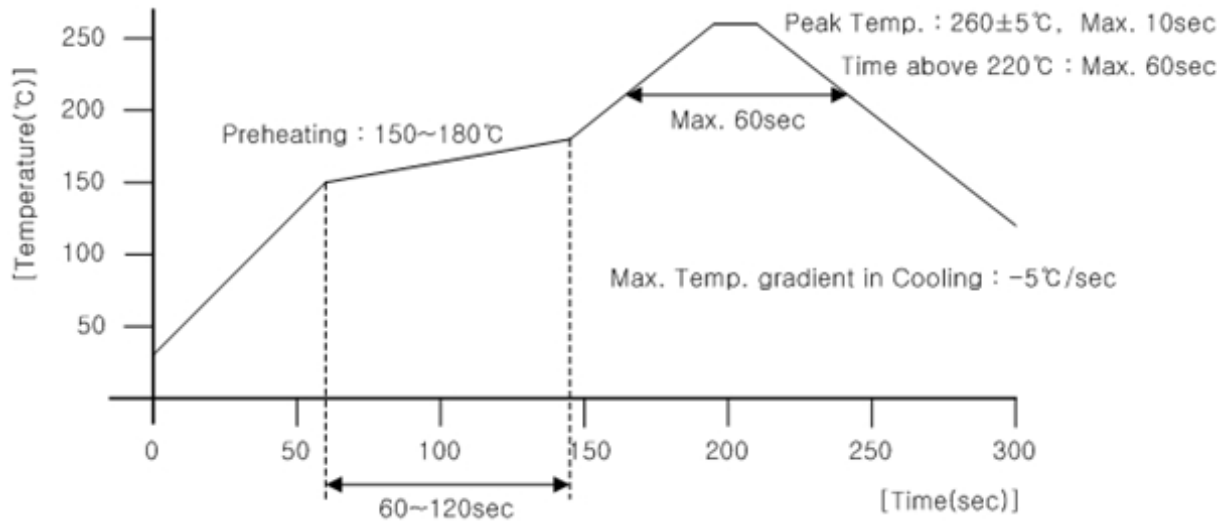

b) Manual Soldering Conditions

Not more than 5 seconds @ max. 300 °C, under soldering iron.

7. Tape & Reel

a) Taping Dimension

(unit: mm)

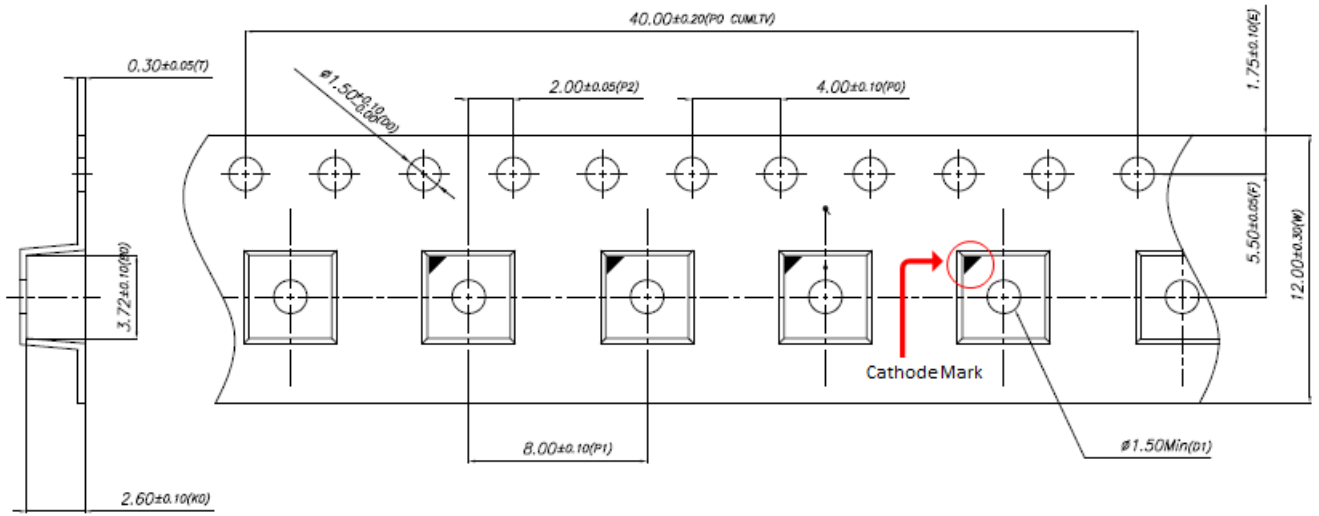

Taping Direction

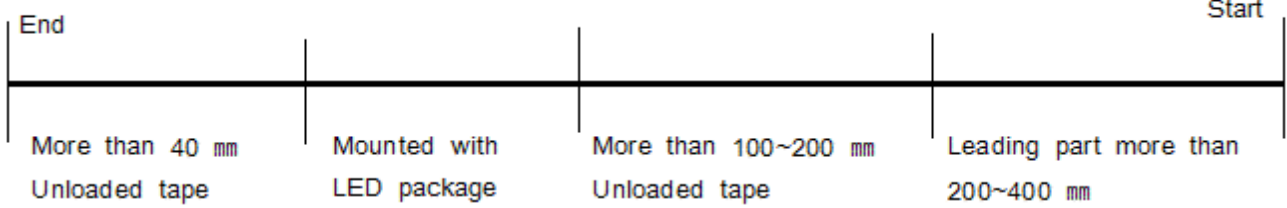

b) Reel Dimension

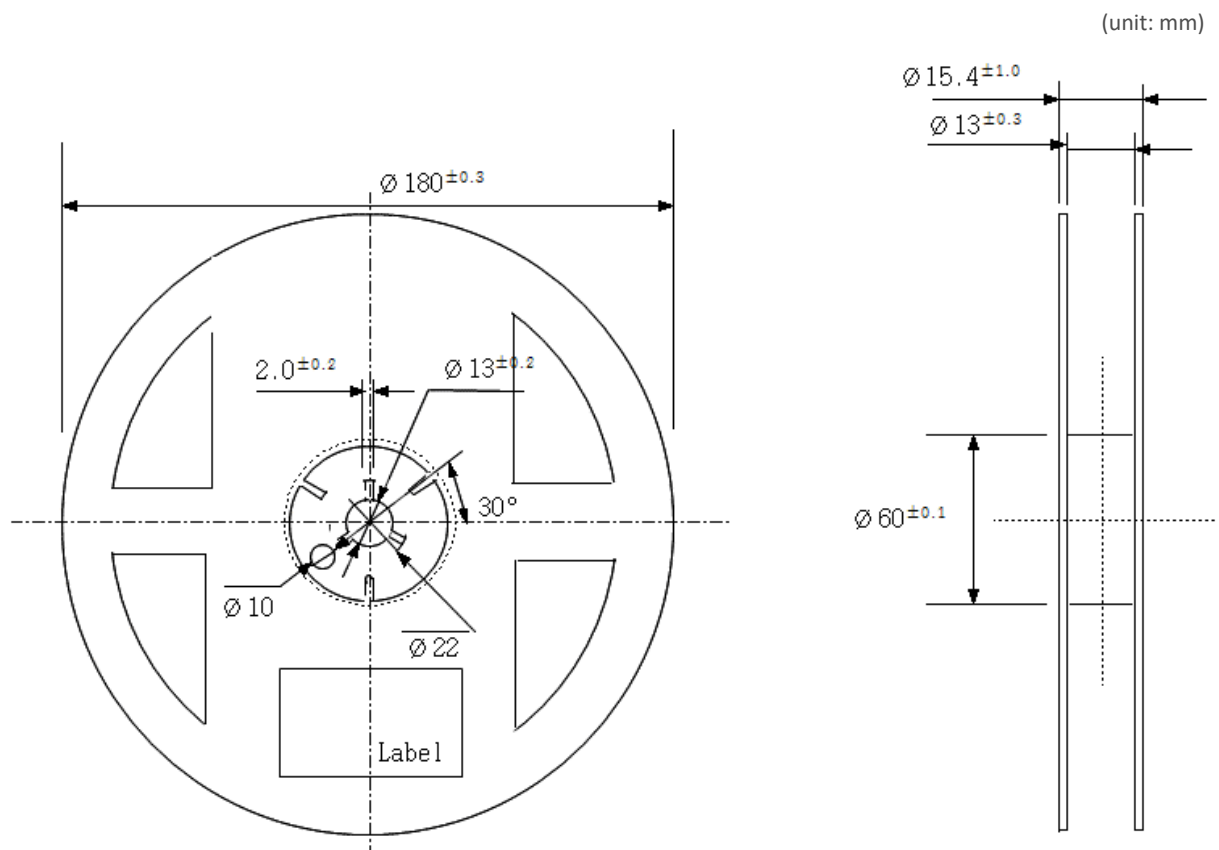

Notes:

- 1) Quantity: The quantity/reel is 800 pcs
- 2) Cumulative tolerance: Cumulative tolerance / 10 pitches is ± 0.2 mm
- 3) Adhesion strength of cover tape: Adhesion strength is 0.1-0.7 N when the cover tape is turned off from the carrier tape at 10° angle to the carrier tape
- 4) Packaging: P/N, Manufacturing data code no. and quantity are indicated on the aluminum packing bag

8. Label Structure

a) Label Structure

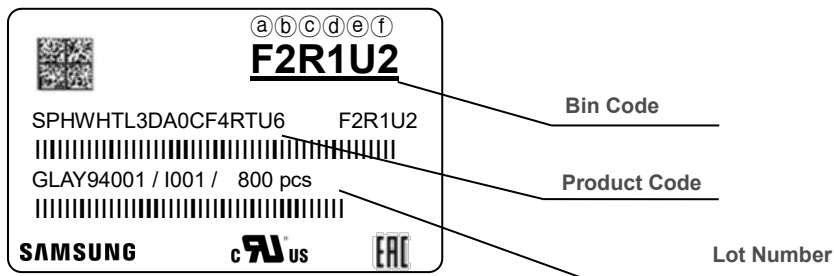

Note: Denoted bin code and product code above is only an example (see description on page 7)

Bin Code:

- ⒶⒷ: Forward Voltage bin (refer to page 9)
- ⒸⒹ: Chromaticity bin (refer to page 10~13)
- ⒺⒻ: Luminous Flux bin (refer to page 7-8)

b) Lot Number

The lot number is composed of the following characters:

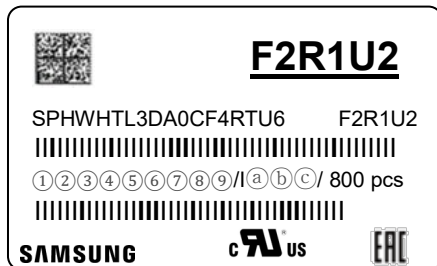

①②③④⑤⑥⑦⑧⑨ / I Ⓐ Ⓑ Ⓒ / 800 pcs

- ①, ② : Production site (GB : Nanchang, China)
- ③ : Product state (A: Normal, B: Bulk, C: First Production, R: Reproduction, S: Sample)
- ④ : Year (Y: 2014, Z: 2015, A: 2016, B: 2017, C: 2018, D: 2019 ...)
- ⑤ : Month (1~9, A, B, C)
- ⑥ : Day (1~9, A, B~V)
- ⑦⑧⑨ : Product serial number (001 ~ 999)
- ⒶⒷⒸ : Reel number (001 ~ 999)

b) Aluminum Vinyl Packing Bag



CAUTION
 This bag contains
MOISTURE SENSITIVE DEVICES

LEVEL
2a

1. Shelf life in sealed bag: 12 months at <40°C and <90% relative humidity (RH)
2. Peak package body temperature: 240 °C
3. After this bag is opened, devices that will be subjected to reflow solder or other high temperature processes must be:
 - a. Mounted within 672 hours at factory conditions of equal to or less than 30°C / 60% RH, or
 - b. Stored at <10% RH
4. Devices require bake, before mounting, if:
 - a. Humidity Indicator Card is > 65% when read at 23±5°C, or
 - b. 2a is not met.
5. If baking is required, devices must be baked for 1 hours at 60±5°C

Note: If device containers cannot be subjected to high temperature or shorter bake times are desired, reference IPC/JEDEC J-STD-033 for bake procedure.

Bag seal due date: _____
 (if blank, see code label)

Note: Level and body temperature by IPC/JEDEC J-STD-020



F2R1U2

SPHWHTL3DA0CF4RTU6 F2R1U2
 GLAY94001 / I001 / 800 pcs

SAMSUNG
c  **US**
EAC



LEAD-FREE





ATTENTION
 OBSERVE PRECAUTIONS
 FOR HANDLING
 ELECTROSTATIC
 SENSITIVE
 DEVICES



OTHER

주의 사항

이 알루미늄 지퍼 팩은 습기 및 정전기로부터 제품을 보호하기 위하여 제작되었습니다. 개봉 후에는 즉시 솔더 작업을 실시하는 것을 권장합니다.

습기 및 정전기로부터 제품을 보호하기 위해서 개봉 후 사용하지 않는 자재는 본 팩에 넣어 보관하시기 바랍니다. 사용하지 않는 자재를 본 팩에 넣을 때는 반드시 동봉된 드라이 팩과 함께 넣고 지퍼부분을 완전하게 밀봉하여 주시기 바랍니다.

Important

This Al Zipper bag is designed to protect the enclosed products from moisture and ESD. Once opened, the products should be soldered onto the printed circuit board immediately. When not in use, please do not leave the products unprotected by the Al Zipper Bag. To repack unused products., please ensure the zip-lock is completely sealed with the dry pack left inside.

c) Silica Gel & Humidity Indicator Card inside Aluminum Vinyl Bag



DESICCANT
SILICA
 DO NOT
 DE
 SIL

HUMISAFE™

HUMIDITY INDICATOR
 COBALT-FREE

10%

20%

30%

40%

50%

60%







READ AT TOP OF GREEN COLOR
 CHANGE BETWEEN YELLOW AND GREEN

Warning If Green
 Change Desiccant

GP&E Co., Ltd.
 6CF-60NS

10. Precautions in Handling & Use

- 1) For over-current protection, users are recommended to apply resistors connected in series with the LEDs to mitigate sudden change of the forward current caused by shift of forward voltage.
- 2) This device should not be used in any type of fluid such as water, oil, organic solvent, etc. When cleaning is required, IPA is recommended as the cleaning agent. Some solvent-based cleaning agent may damage the silicone resins used in the device.
- 3) When the device is in operation, the forward current should be carefully determined considering the maximum ambient temperature and corresponding junction temperature.
- 4) LEDs must be stored in a clean environment. Shelf life of sealed bags is 12 months at temperature 0~40 °C, 0~90 % RH.
- 5) After storage bag is opened, device subjected to soldering, solder reflow, or other high temperature processes must be:
 - a. Mounted within 672 hours (28 days) at an assembly line with a condition of no more than 30 °C / 60 % RH, or
 - b. Stored at <10 % RH
- 6) Repack unused devices with anti-moisture packing, fold to close any opening and then store in a dry place.
- 7) Devices require baking before mounting, if humidity card reading is >60 % at 23 ± 5 °C.
- 8) Devices must be baked for 1 hour at 60 ± 5 °C, if baking is required.
- 9) The LEDs are sensitive to the static electricity and surge current. It is recommended to use a wrist band or anti-electrostatic glove when handling the LEDs. If voltage exceeding the absolute maximum rating is applied to LEDs, it may cause damage or even destruction to LED devices. Damaged LEDs may show some unusual characteristics such as increase in leakage current, lowered turn-on voltage, or abnormal lighting of LEDs at low current.
- 10) VOCs (Volatile Organic Compounds) can be generated from adhesives, flux, hardener or organic additives used in luminaires (fixtures). Transparent LED silicone encapsulant is permeable to those chemicals and they may lead to a discoloration of encapsulant when they exposed to heat or light. This phenomenon can cause a significant loss of light emitted (output) from the luminaires. In order to prevent these problems, we recommend users to know the physical properties of materials used in luminaires and they must be carefully selected.

Legal and additional information.

[About Samsung Electronics Co., Ltd.](#)

Samsung Electronics Co., Ltd. inspires the world and shapes the future with transformative ideas and technologies, redefining the worlds of TVs, smartphones, wearable devices, tablets, cameras, digital appliances, printers, medical equipment, network systems and semiconductors.

We are also leading in the Internet of Things space through, among others, our Digital Health and Smart Home initiatives. We employ 307,000 people across 84 countries. To discover more, please visit our official website at www.samsung.com and our official blog at global.samsungtomorrow.com.

“Samsung provides limited warranty for its LED products, the full text of which is available at <https://www.samsung.com/led/support/warranties>“

Copyright © 2017 Samsung Electronics Co., Ltd. All rights reserved.

Samsung is a registered trademark of Samsung Electronics Co., Ltd.

Specifications and designs are subject to change without notice. Non-metric weights and measurements are approximate. All data were deemed correct at time of creation. Samsung is not liable for errors or omissions. All brand, product, service names and logos are trademarks and/or registered trademarks of their respective owners and are hereby recognized and acknowledged.

Samsung Electronics Co., Ltd.

1, Samsung ro

Giheung-gu

Yongin-si, Gyeonggi-do, 17113

KOREA

www.samsungled.com

The Samsung logo, consisting of the word "SAMSUNG" in a bold, blue, sans-serif font.