



LEDD24_24 Series

Constant current power DIP24 LED Driver - Wide Input - Non-Isolated & Regulated

LED Driver

- ⊕ High efficiency up to 97%
- ⊕ Short Circuit Protection (SCP)
- ⊕ Output current: Max 1200mA
- ⊕ Ultra wide range of voltage (input and output)
- ⊕ Constant current mode, high power output
- ⊕ PWM dimming & Analogue dimming
- ⊕ Switching-on/off control function
- ⊕ Built-in EMI filter circuit, meet EN55015 standards

The LEDD24_24 is a step-down constant current sources for driving high-power LED featured in high efficiency and wide range of input voltage, high operating temperature, and act in PWM dimming, analogue dimming and remote turn-off.

The product can be widely applied to fields such as landscape lighting, specially-controlled lighting, backlight, business lighting, street lamp lighting, domestic lighting and automobile lighting.



Specifications					
Item	Operating condition	Min	Typ	Max	Units
Input voltage limit	≤10 seconds	5		55	VDC
Input voltage range		5.5	24	48	VDC
Input filter	Pi Filter				
Min. input-output voltage drop	Input voltage range	2		4	VDC
Output power	• Io=1000mA • Io=1200mA	3.3 3.96		36 43.2	W W
Output current accuracy			±3	±5	%
Output current stability			±0.5	±1	%
Temperature drift coefficient	Vin=48V,Vo=10LEDs			±0.05	%/°C
Ripple & Noise*	20MHz bandwidth		70	200	mVp-p
Over temperature protection	Self-recovery after cooling				
Short circuit protection	Continuous, automatic recovery				
Operating temperature range	Derating if the temperature ≥71°C (see typical characteristics)	-40		85	°C
Storage temperature range		-55		125	°C
Storage humidity				95	%RH
Cooling method	Free air convection				
Lead temperature	Welding spot is 1.5mm away from the casing, 10 seconds			265	°C
Switching frequency			370		kHz
MTBF	MIL-HDBK-217F (+25°C)				K hours
Case Material	Epoxy Resin (UL94-V0)				
Dimensions		31.70*20.30*12.65			mm
Weight			13		g

*Ripple and noise tested with "parallel cable" method, please see DC-DC Converter Application Notes for specific operation methods.

Model selection:

LEDC_xx-###

LED=Type; C=Case; yy=Vin; ###= Output Current

Example:

LEDD24_24-1000

LED= Series D24= DIP24; yy= 24VDC nominal; 1000= 1A

PWM dimming and ON/OFF control

Item	Test condition	Min	Typ	Max	Units
Remote ON/OFF (Vin=5.5~48V)	ON OFF (shutdown)			Open or 2.8V<Vc<6V Vc<0.6V	
PWM dimming Pin suspended voltage	Vin=24V, 5LED		3.3		V
PWM dimming Pin Isink	Vc=5V			1	mA
PWM dimming Pin Isource	Vc <0.6V		1		µA
Turn-off-mode Static Input Current	Vin=24V, Vc <0.6V		400		µA
PWM dimming frequency*				200	Hz

*Refer to "Digital Dimming Control" on page 4.

Analogue dimming

Item	Test condition	Min	Typ	Max	Units
Input voltage range	Vin=5.5-48V			15	V
Output current range	Vin=5.5-48V			100	%
Control voltage range	Full on Full off			0.2V±50mV 4.5V±200mV	
Driving current	Vc=5V			0.6	mA

EMC specifications

EMI	Conducted disturbance	CISPR22/EN55022 CLASS B	EN55015 power port		
EMI	Radiated emission	CISPR22/EN55022 CLASS B			
EMS	Electrostatic Discharge	IEC/EN61000-4-2 perf. Criteria B	Contact ±4KV		
EMS	Radiation Immunity	IEC/EN61000-4-3	10V/m	perf. Criteria A	
EMS	EFT	IEC/EN61000-4-4 (see recommended circuit)	±2KV	perf. Criteria B	
EMS	Surge Immunity	IEC/EN61000-4-5 (see recommended circuit)	±2KV	perf. Criteria B	
EMS	Conducted Disturbance Immunity	IEC/EN61000-4-6	3 Vr.m.s	perf. Criteria A	
EMS	Voltage dips, short and interruptions immunity	IEC/EN61000-4-29	0%-70%	perf. Criteria B	

LEDD24_24 Series

Constant current power DIP24 LED Driver - Wide Input - Non-Isolated & Regulated

Part Number	Input Voltage [VDC] Nominal (Range)	Input Current (mA) @Vin=24V Vo=17V	Output Voltage [VDC]	Output Current [mA]	Efficiency [%, typ]	Max- capacitive load μ F
LEDD24_24-1000	24 (5.5-48)	740	3.3-36	1000	97	1000
LEDD24_24-1200	24 (5.5-48)	892	3.3-36	1200	97	1000

Input vs. Output

Input voltage	Output voltage range [VDC]	Output constant current [mA]	Output power [W, max]
48	3.3-36.0	1000	36
36	3.3-32.0	1000	32
24	3.3-21.0	1000	21
20	3.3-17.0	1000	17
15	3.3-13.2	1000	13.2
12	3.3-10.0	1000	10
5.5	3.3-4.0	1000	4

Input voltage	Output voltage range [VDC]	Output constant current [mA]	Output power [W, max]
48	3.3-36.0	1200	43.2
36	3.3-32.0	1200	38.4
24	3.3-21.0	1200	25.2
20	3.3-17.0	1200	20.4
15	3.3-13.2	1200	15.84
12	3.3-10.0	1200	12
5.5	3.3-4.0	1200	4.8

Typical characteristics

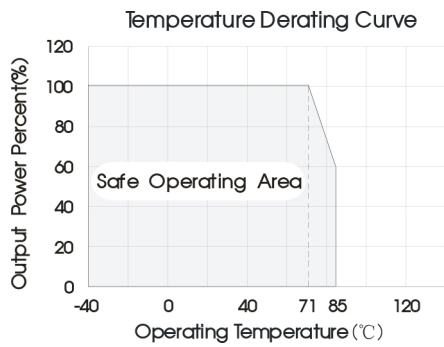

Efficiency

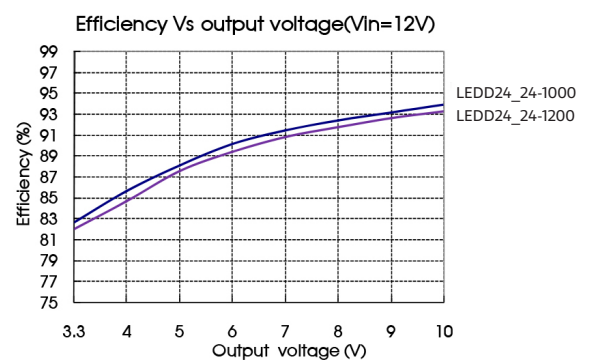
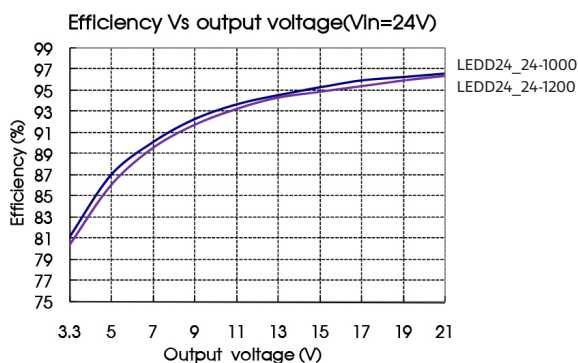
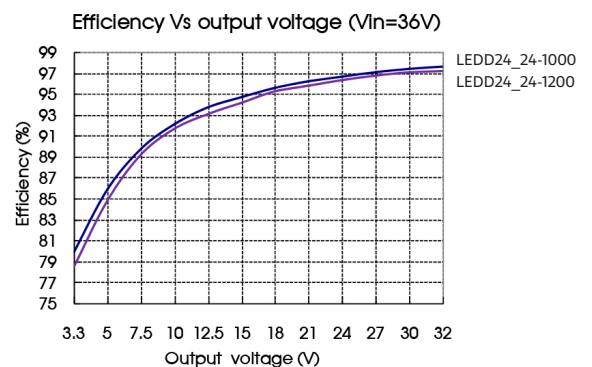
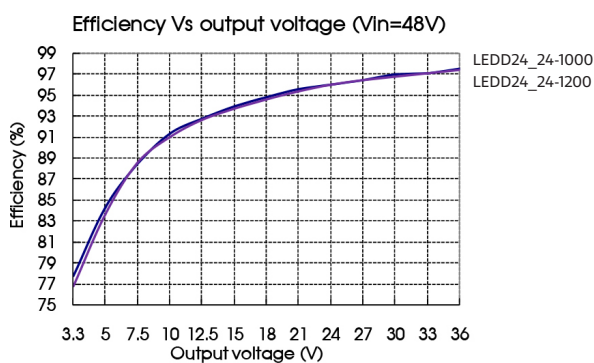

LEDD24_24 Series

Constant current power DIP24 LED Driver - Wide Input - Non-Isolated & Regulated

Typical application circuit

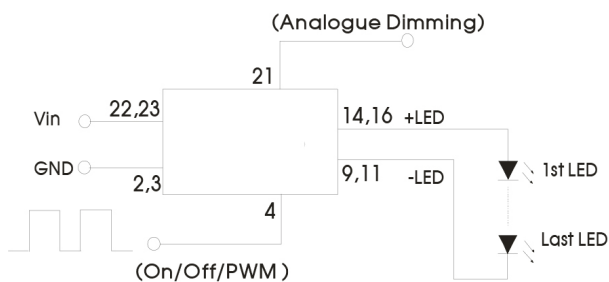

Application circuits in series

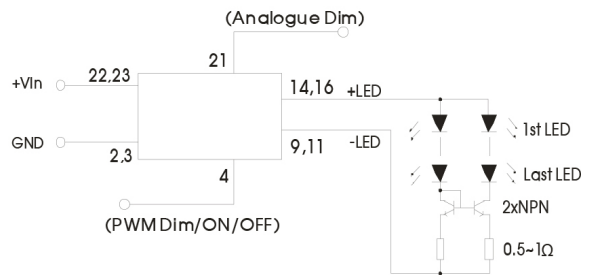

Application circuits in series and parall

1. If the product is applied to high voltage condition (higher than 40V), the input terminal must be provided with an additional capacitor ($\geq 47\mu\text{F}/100\text{V}$) to prevent voltage spike from damaging the module.
2. The output cathode cannot be connected with the input grounding, or it will damage the module.

AC input recommended circuit

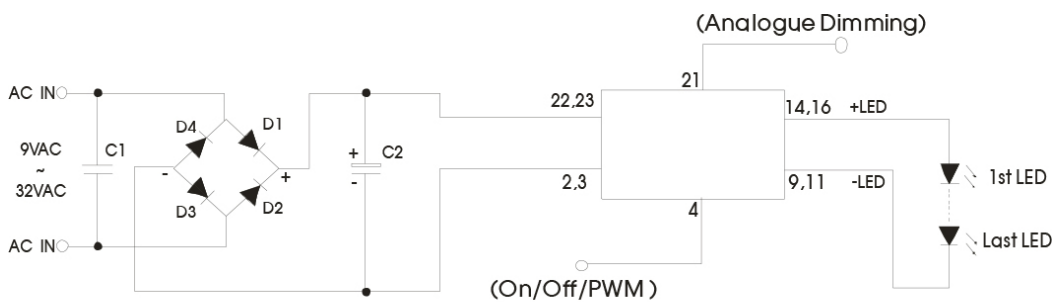

EMC solution-recommended circuit

EMC recommended circuit

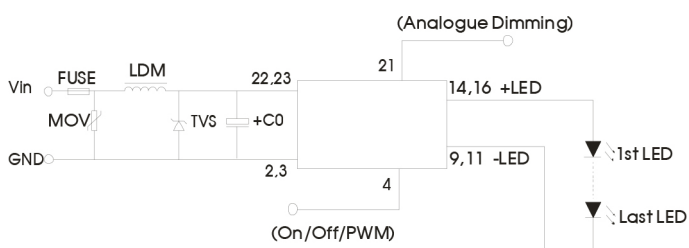

Recommended parameter:

Components	Specifications
C1	Safety-regulated X1 film capacitor, 0.1 μF /3000VAC
C2	100 μF /100V electrolytic capacitor
D1, D2, D3, D4	Rectifier diode (2A/200V)

Recommended parameter:

Components	Specifications
FUSE	Selected based on the actual input current from the customer
MOV	S10K35
TVS	SMC54A
LDM	56 μFH
C0	120 μF /63V

EMC solution-recommended circuit PCB layout

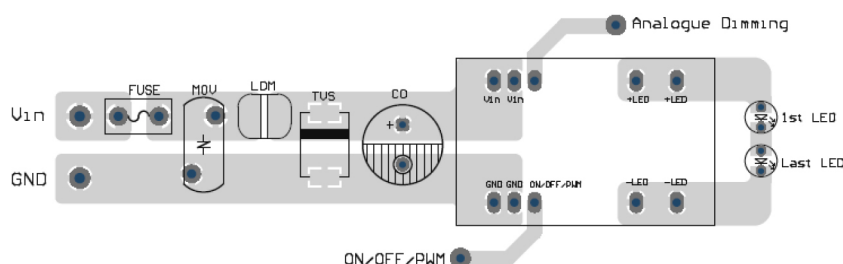

LEDD24_24 Series

Constant current power DIP24 LED Driver - Wide Input - Non-Isolated & Regulated

Digital dimming control

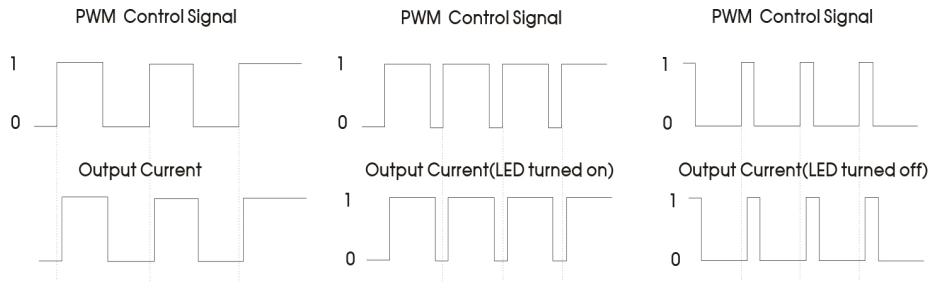

For PWM dimming signals with a certain frequency, the output current of the driver is related to the duty ratio of PWM signal. Refer to the formula for the calculation method:

$$I_{o_set} = \frac{(DT-0.75)}{T} I_{o_norm}$$

Where, I_{o_set} represents required output current (mA); D represents the duty ratio (%) of PWM signal; T represents the period (ms) of PWM signal; and I_{o_norm} represents the rated output value (mA) of the driver.

Note: The above formula is for reference only; and deviation of output current may exist due to various loads. The min. conducted time of PWM signal shall not be less than 0.75ms, or the product will be in abnormal operation; in case of low voice from the driver during PWM dimming, it

is normal since the PWM dimming frequency is within the auditory frequency range of human ears (20Hz-20KHz in general). To prevent seeing flash of the LED by human eyes, it is suggested to set the PWM dimming frequency between 100-200Hz.

PWM curve($V_{in}=24V, 5LEDs$):

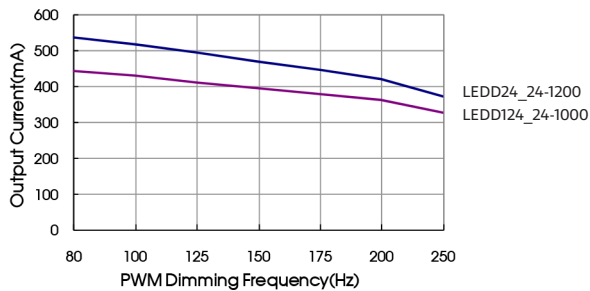

PWM dimming frequency and output current (D=50%)

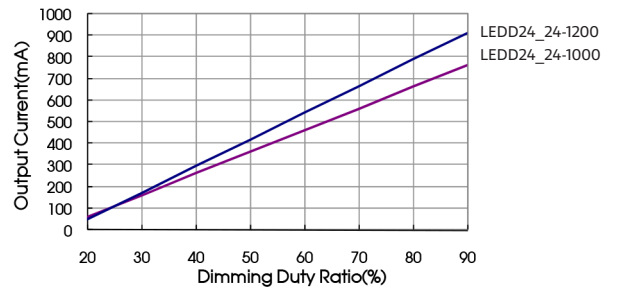

Dimming duty ratio and output current (f=200Hz)

Analogue dimming control and application sample

Analogue dimming circuit

Analogue dimming and typical application

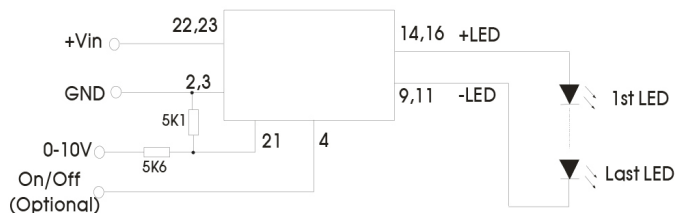

Analogue dimming circuit

Analogue input voltage vs. output

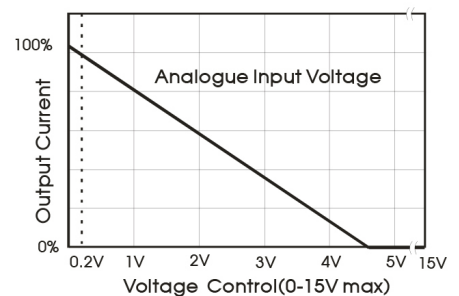

Analogue input voltage and output current

The voltage drop of all LEDs in the datasheet is 3.3-3.8V during actual application, the number of LEDs can be confirmed based on the actual voltage drop and output voltage of LEDs.

This product does not support hot-Plug use.

LEDD24_24 Series

Constant current power DIP24 LED Driver - Wide Input - Non-Isolated & Regulated

Mechanical dimensions

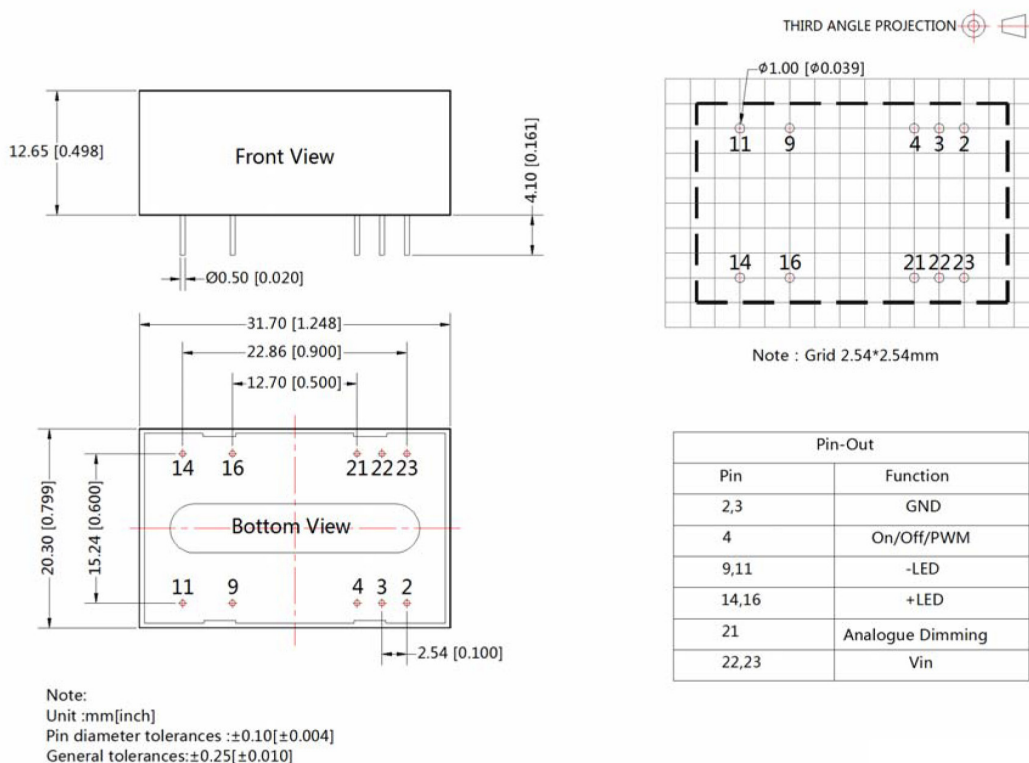

Note:

1. If the product is not operated within the required load range, the product performance cannot be guaranteed to comply with all parameters in the datasheet;
2. The maximum capacitive load offered were tested at nominal input voltage and full load;
3. Unless otherwise specified, parameters in this datasheet were measured under the conditions of Ta=25°C, humidity<75% with nominal input voltage and rated output load;
4. All index testing methods are based on our Company's corporate standards;
5. We can provide product customization service;
6. Specifications are subject to change without prior notice.