

SPECIFICATIONS:

MATERIALS:

SHELL: NICKEL PLATED STEEL
 INSULATOR: PA6T, UL94 V-0
 PROCESS TEMP: 260°C
 CONTACTS: GOLD PLATED BRASS (FLOATING CONTACTS)

ELECTRICAL:

RATED CURRENT: 5A
 VOLTAGE: 500VAC FOR 1 MINUTE
 INSULATION RESISTANCE: 1000 MOhms MIN.
 CONTACT RESISTANCE: 15 mOhms MAX.

ENVIRONMENT:

OPERATING TEMPERATURE: -50°C TO +100°C

DIMENSIONS(mm)							
SIZE	A ^{±.36}	B ^{±.10}	C ^{±.15}	D ^{±.15}	E ^{±.38}	F ^{±.25}	G (REF)
9	30.80	24.99	16.30	8.00	19.20	12.60	10.75
15	39.15	33.32	24.60	8.00	27.70	12.60	10.75
25	53.04	47.04	38.40	8.00	41.10	12.60	10.75
37	69.32	63.50	54.80	8.00	57.30	12.60	10.75
50	66.93	61.11	52.30	10.80	55.10	15.20	13.30

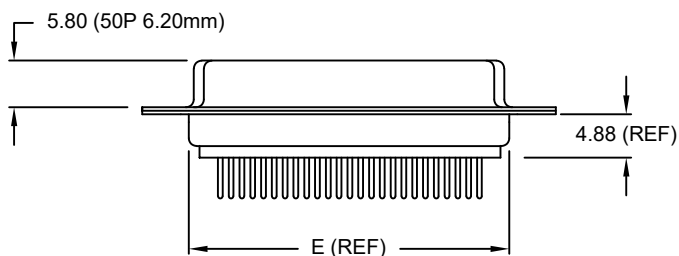
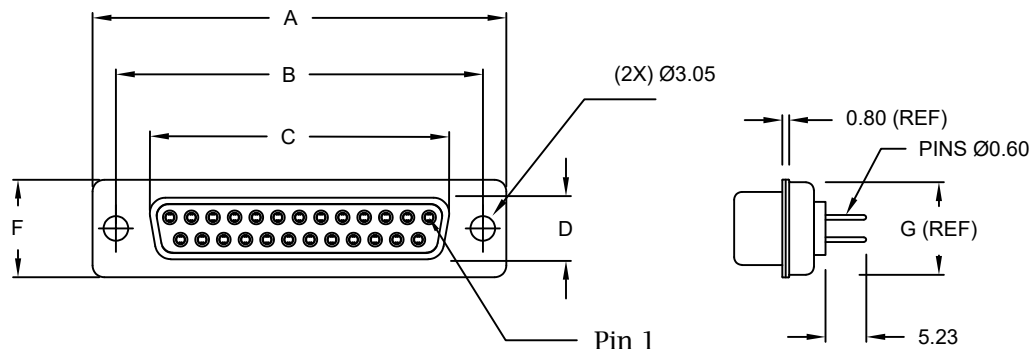

172-YYY-213RYY1

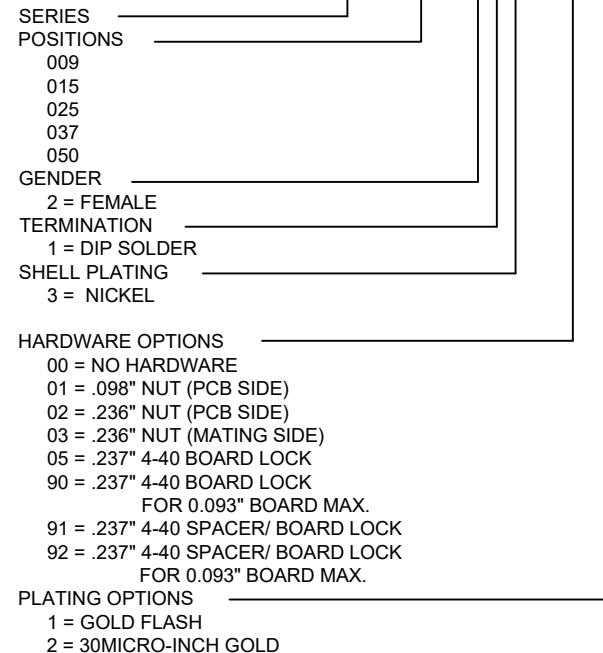

RoHS COMPLIANT

UNITS = mm

DO NOT SCALE FROM DRAWING



THESE DRAWINGS AND SPECIFICATIONS ARE THE PROPERTY OF NorComp AND SHALL NOT BE REPRODUCED, COPIED OR USED AS THE BASIS FOR THE MANUFACTURE OR SALE OF APPARATUS WITHOUT WRITTEN PERMISSION.

DRAWN: P. JENKINS

DATE: 09/12/2005

NorComp

SCALE: NTS

SHEET 1 OF 3

REV 24

DWG NO.

172-YYY-213RYY1

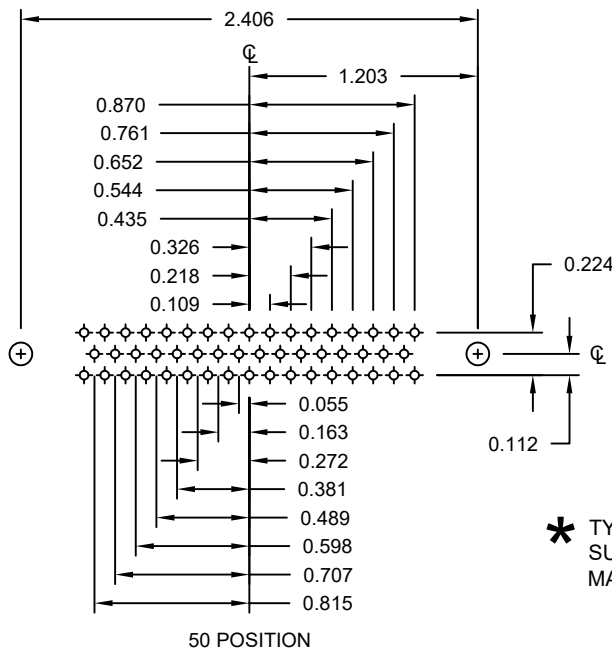
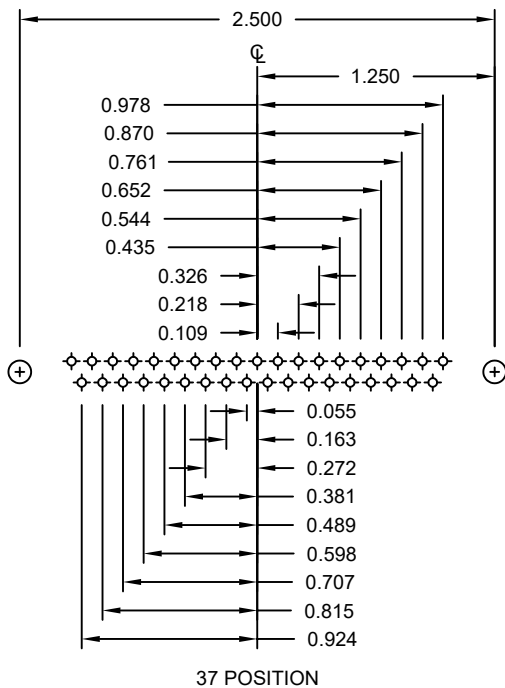
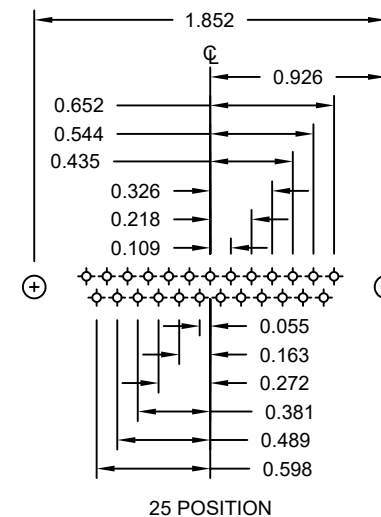
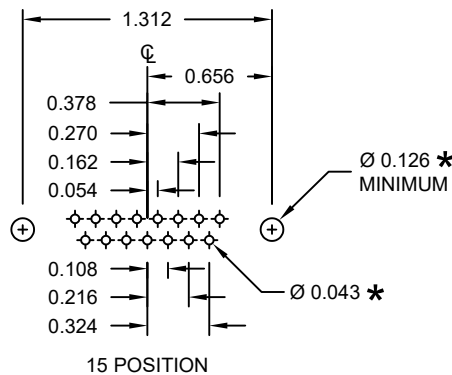
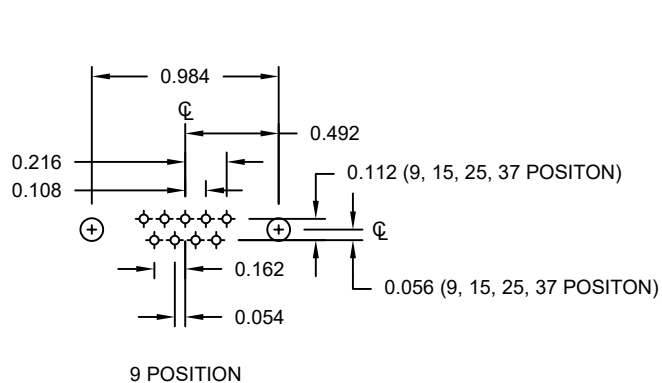

* TYP.
SUGGESTED SIZE
MAY NOT BE SUITABLE FOR ALL APPLICATIONS

RoHS COMPLIANT

UNITS = inch

DO NOT SCALE FROM DRAWING



THESE DRAWINGS AND SPECIFICATIONS ARE THE PROPERTY OF NorComp AND SHALL NOT BE REPRODUCED, COPIED OR USED AS THE BASIS FOR THE MANUFACTURE OR SALE OF APPARATUS WITHOUT WRITTEN PERMISSION.

DRAWN:
P. JENKINS

DATE:
09/12/2005

NorComp

SCALE:
NTS

SHEET OF
2 3

REV
24

DWG NO.

172-YYY-213RYY1

TOLERANCE:
 ALL DIMENSIONS ARE ± 0.010
 UNLESS OTHERWISE
 SPECIFIED

ALL CLINCH-NUTS ARE 4-40 INTERNAL THREADS

****NOTE: 90 & 92 OPTION FOR 0.093" MAX. BOARD THICKNESS**

"01" // PCB SIDE

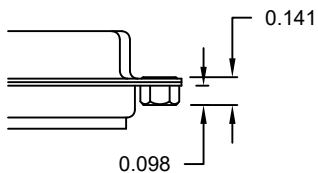

"02" // PCB SIDE

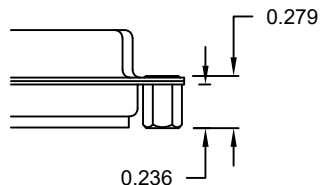

"03" // MATING SIDE

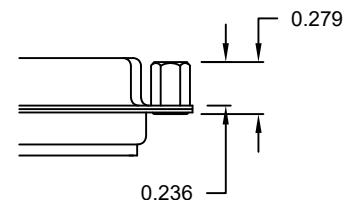

"05" // PCB SIDE

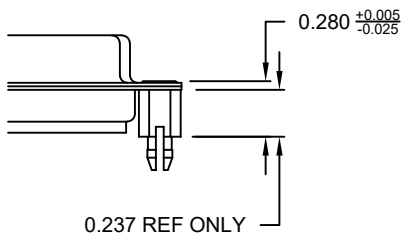

"91" // PCB SIDE

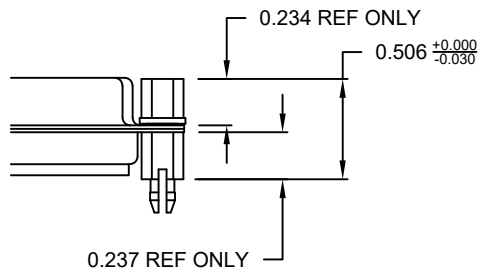

"90" // PCB SIDE **

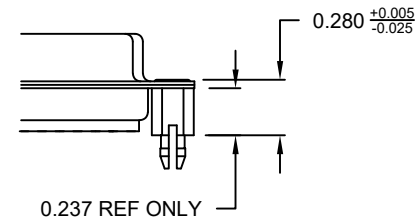

NOTE: 4-40 FEMALE SCREW LOCK IS REMOVABLE

"92" // PCB SIDE **

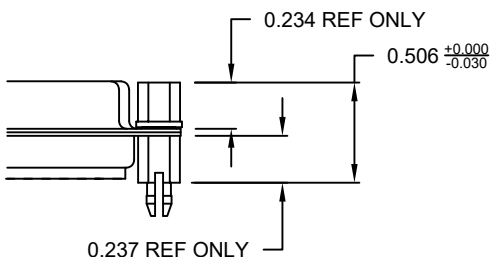

**50 in-oz
 Max Torque**

RoHS COMPLIANT

UNITS = inch

DO NOT SCALE FROM DRAWING



THESE DRAWINGS AND SPECIFICATIONS ARE THE PROPERTY OF NorComp AND SHALL NOT BE REPRODUCED, COPIED OR USED AS THE BASIS FOR THE MANUFACTURE OR SALE OF APPARATUS WITHOUT WRITTEN PERMISSION.

DRAWN:
P. JENKINS
 DATE:
09/12/2005

NorComp

SCALE: NTS	SHEET 3	OF 3	REV 24
DWG NO.		172-YYY-213RYY1	