

NSS085N100S

N-channel 100V Enhancement Mode Power MOSFET



VOLTAGE: 100 Volts

CURRENT: 100 Amper

TO-252 Marking and Polarity

FEATURES

- Advanced trench MOSFET technology
- Low RDS(ON)
- Ultra Low Gate Charge
- RoHS Compliant
- 100% UIS and RG Tested
- High Power and current handing capability

TYPICAL APPLICATIONS

- PD Charger V-BUS
- SMPS 2nd Synchronous Rectifier
- MB/VGA Vcore
- BLDC Motor driver
- POL application

PRODUCT SUMMARY

B_{VDS} ,Min. at Max. Tj	100	V
I_D	100	A
$R_{DS(ON)}$,Max. at Vgs=10V	9.5	mΩ
Qg,Typ.	43	nC

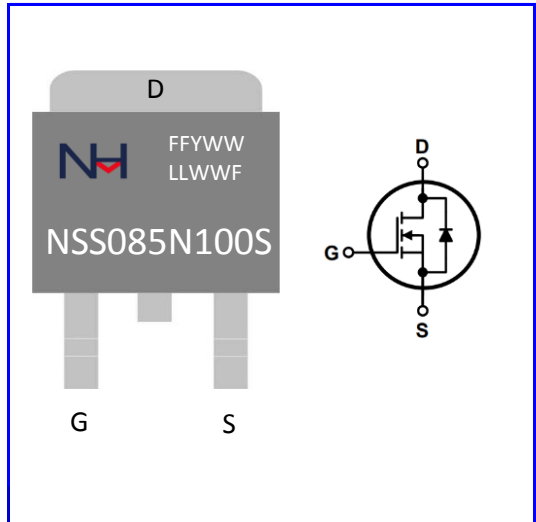

Remark:

- NH=niuhang trademark;
- FF=Product line code,According to actual changes
YWW=Data code,According to actual changes
LLWWF=Internal code,According to actual changes
- NSS085N100S=Model.

Absolute Maximum Ratings (Ratings at 25°C ambient temperature unless otherwise specified)

Parameter	Test Conditions	Symbol	Ratings	Unit
Drain-Source Voltage		V_{DS}	100	V
Gate-Source Voltage		V_{GS}	±20	V
Continuous Drain Current (Note 1)	Ta=25°C	I_D	100	A
	Ta=100°C		64	
Drain Current-Pulsed (Note 1)		I_{DM}	300	A
Maximum Power Dissipation	Ta=25°C	P_D	150	W
Power Dissipation Derating Factor above 25°C	Ta=100°C		60	
Derating Factor		D_F	1.20	W/°C
Junction Temperature		T_J	-55 to 150	°C
Storage temperature range		T_{STD}	-55 to 150	°C
Avalanche Current,Single pulse	L= 0.5 mH	I_{AS}	38	A
Single Pulse Avalanche Energy	L=0.5mH,IAS=38A, VDD=50V, RG=25Ω, Starting Tj =25°C	E_{AS}	361	mJ

Thermal Characteristics (Ratings at 25°C ambient temperature unless otherwise specified)

Parameter	Symbol	Max	Unit
Thermal Resistance Junction to Ambient	$R_{θJA}$	50	°C/W
Thermal Resistance Junction-Case (Note 2)	$R_{θJC}$	0.84	°C/W

- Notes:
- Repetitive Rating : Pulse width limited by maximum junction temperature
 - The value of $R_{θJA}$ is measured with the device mounted on 1in2 FR-4 board with 2oz. Copper, in a still air environment with TA =25° C.
The value in any given application depends on the user's specific board design.This transistor is sensitive to electrostatic discharge and should be handled with care.

NSS085N100S

N-channel 100V Enhancement Mode Power MOSFET



Electrical Characteristics (Ratings at 25°C ambient temperature unless otherwise specified)						
Parameter	Symbol	Test Conditions	Min.	Typ.	Max.	Unit
Static off Characteristics						
Drain-Source Breakdown Voltage	BV_{DSS}	$V_{GS}=0V, I_D=250\mu A$	100	-	-	V
Drain-Source Leakage Current	I_{DSS}	$V_{DS}=60V, V_{GS}=0V$	-	-	1	μA
Gate-Body Leakage Current	I_{GSS}	$V_{GS}=\pm 20V, V_{DS}=0V$	-	-	± 100	nA
Static on Characteristics						
Gate Threshold Voltage	$V_{GS(TH)}$	$V_{GS}=V_{DS}, I_D=250\mu A$	1.0	2.0	3.0	V
Drain-Source On Resistance	$R_{DS(ON)}$	$V_{GS}=10V, I_D=2A$	-	7.5	11.0	m Ω
		$V_{GS}=4.5V, I_D=2A$	-	11.0	14.5	
Forward Transconductance	g_{FS}	$V_{DS}=5V, I_D=10A$	-	12	-	S
Dynamic Characteristics						
Input Capacitance	C_{iss}	$V_{DS}=35V, V_{GS}=0V, f=1.0MHz$	-	2000	-	pF
Output Capacitance	C_{oss}		-	820	-	pF
Reverse Transfer Capacitance	C_{rss}		-	80	-	pF
Switching Parameters						
Turn-On Delay Time	$t_{d(on)}$	$V_{DS}=0V, I_D=50A, V_{GS}=10V, R_G=3\Omega$	-	9	-	ns
Turn-On Rise Time	t_r		-	7	-	ns
Turn-Off Delay Time	$t_{d(off)}$		-	50	-	ns
Turn-Off Rise Time	t_f		-	11	-	ns
Gate Resistance	R_g	$V_{DS}=0V, V_{GS}=0V, f=1.0MHz$	-	1.0	-	Ω
Total Gate Charge	Q_g	$V_{DS}=50V, I_D=50A, V_{GS}=10V$	-	43	-	nC
Gate-Source Charge	Q_{gs}		-	6.5	-	nC
Gate-Drain Charge	Q_{gd}		-	8.0	-	nc
Drain-Source Diode Characteristics and Maximum Ratings						
Max. Diode Forward Current	I_{SD}		-	-	100	A
Max. Pulsed Forward Current	I_{SM}		-	-	300	A
Diode Forward Voltage	V_{SD}	$V_{GS}=0V, I_S=10A$	-	0.8	1.2	V
Reverse Recovery Time	t_{rr}	$I_F=20A, di/dt=500A/\mu s$	-	27	-	ns
Reverse Recovery Charge	Q_{rr}		-	113	-	μC

NSS085N100S

N-channel 100V Enhancement Mode Power MOSFET



Typical Characteristics Curves

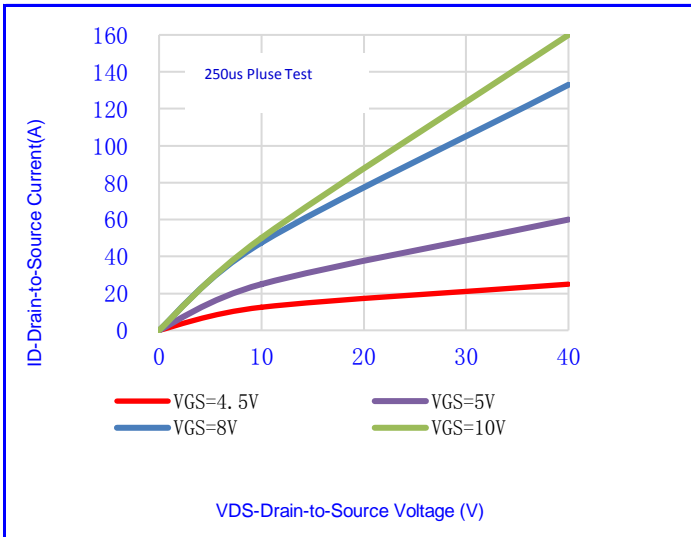

Fig.1-Output Characteristics

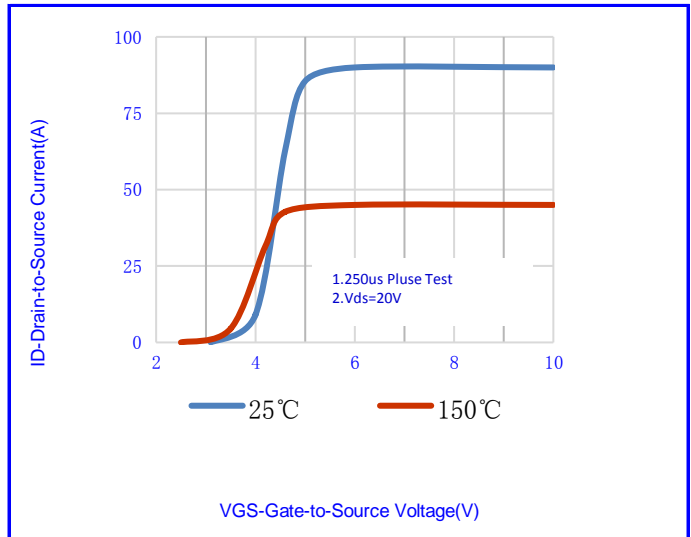

Fig.2- Transfer Characteristics

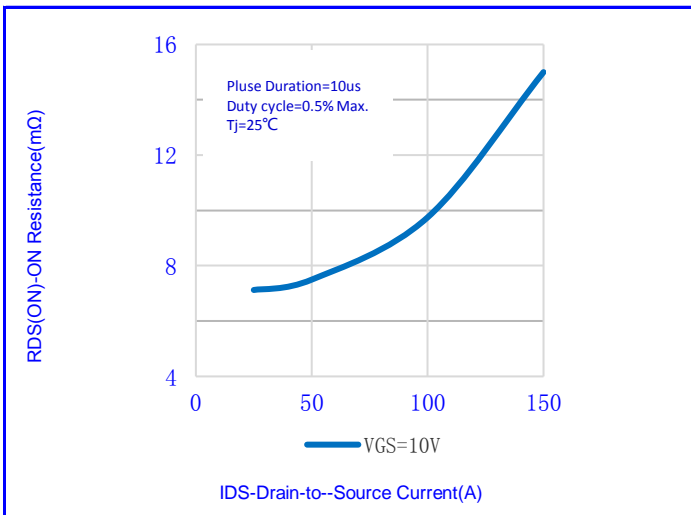

Fig.3- On Resistance vs. Drain Current

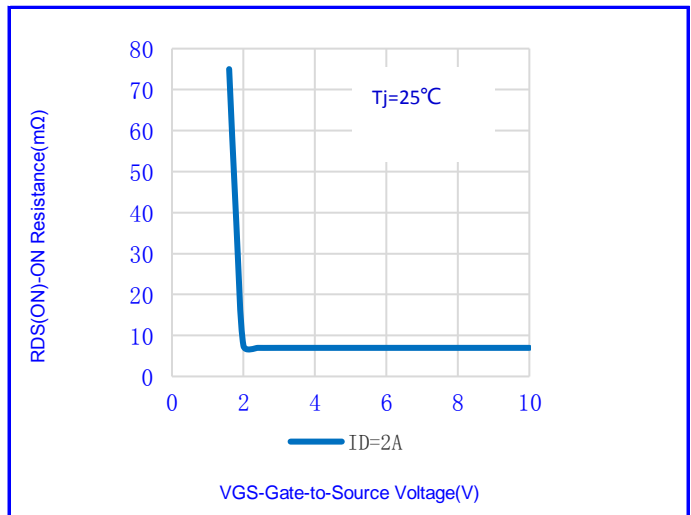

Fig.4- On Resistance vs. Gate Source Voltage

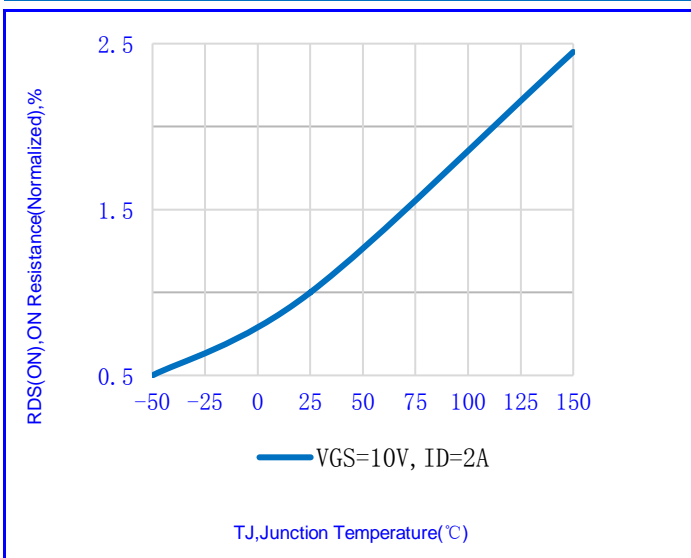

Fig.5- On Resistance vs. Junction Temperature

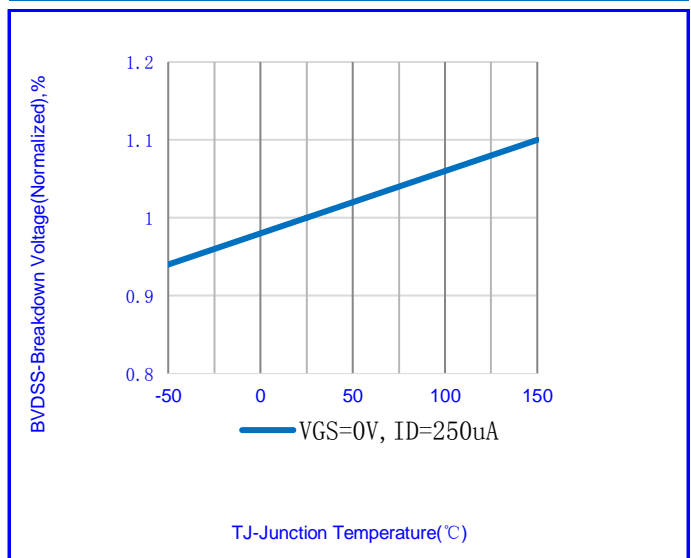

Fig.6- Breakdown Voltage vs. Junction Temperature

NSS085N100S

N-channel 100V Enhancement Mode Power MOSFET



Typical Characteristics Curves

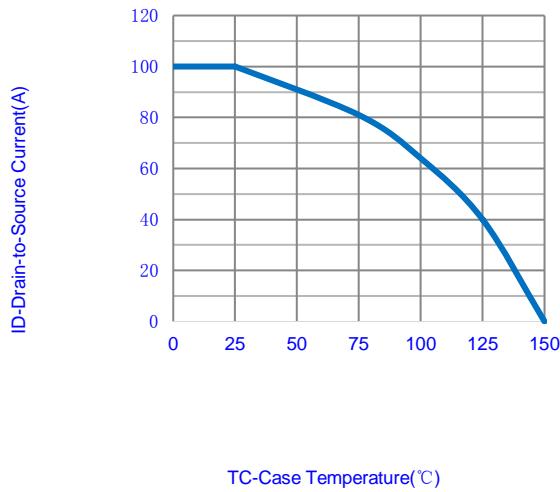

Fig.7-Maximum Continuous Drain Current vs. Case Temperature

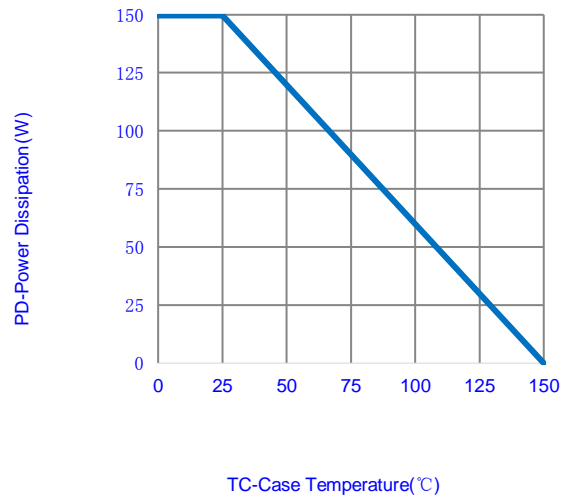

Fig.8-Maximum Power Dissipation vs. Case Temperature

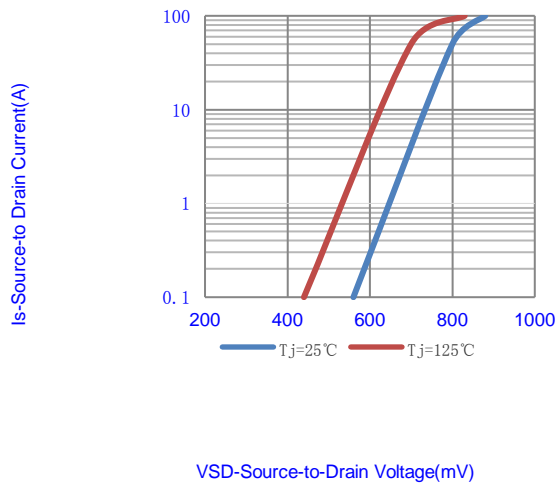

Fig.9- Source-Drain Diode Forward Voltage

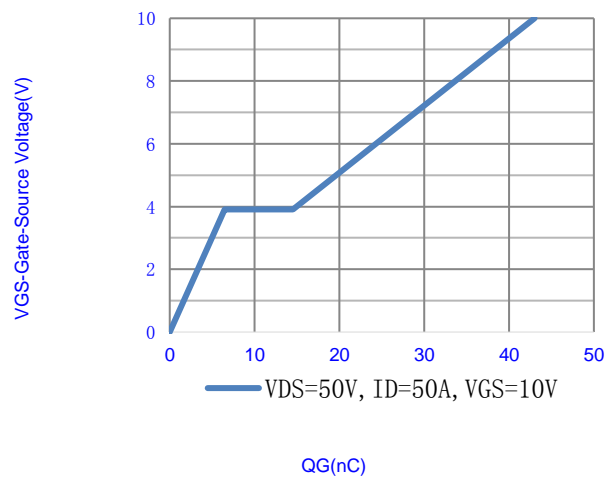

Fig.10-Gate Charge Waveform

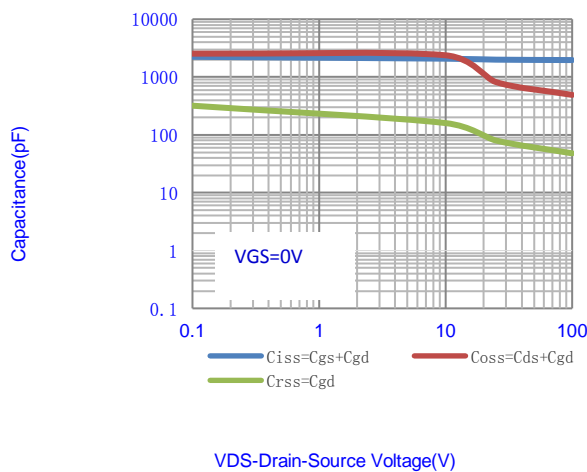

Fig.11- Gate-Source Voltage-VGS(V)

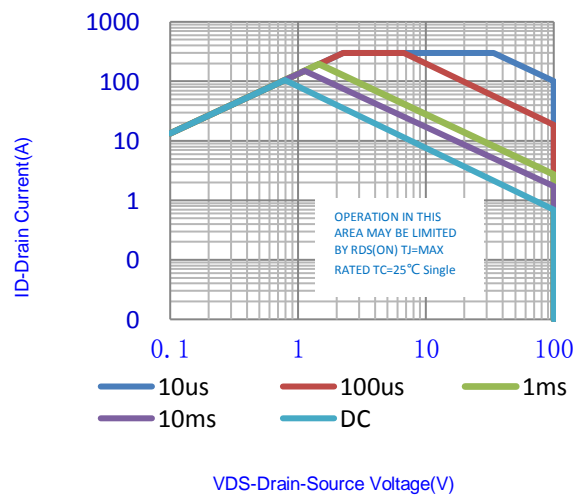

Fig.12-Maximum Safe Operating Area(SOA)

NSS085N100S

N-channel 100V Enhancement Mode Power MOSFET



Test Circuit & Waveform

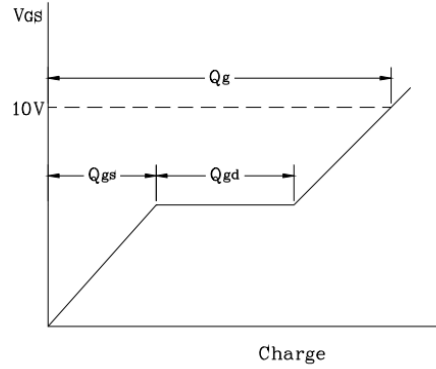
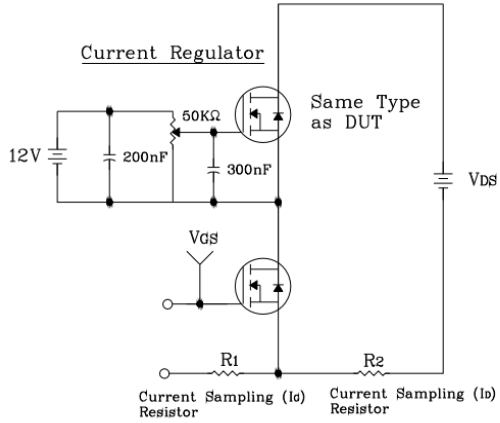

Fig.12-Gate Charge Test Circuit & Waveform

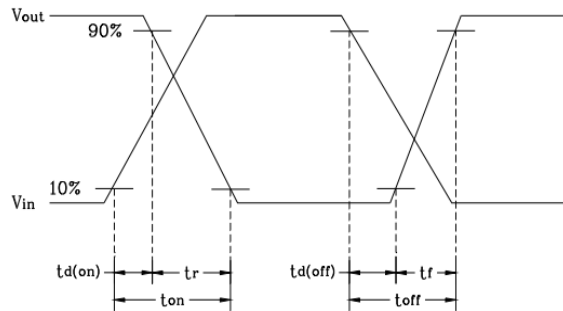
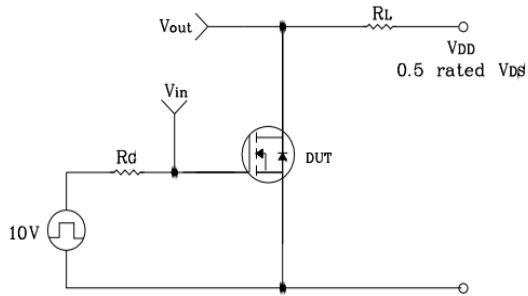

Fig.13- Resistive Switching Test Circuit & Waveform

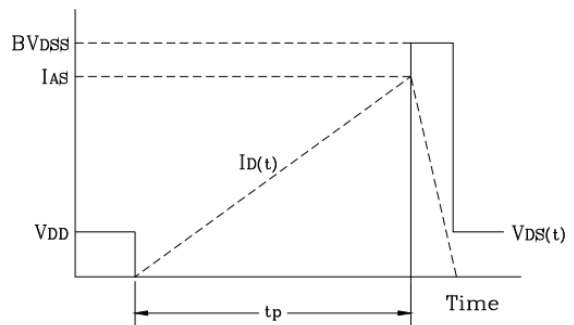
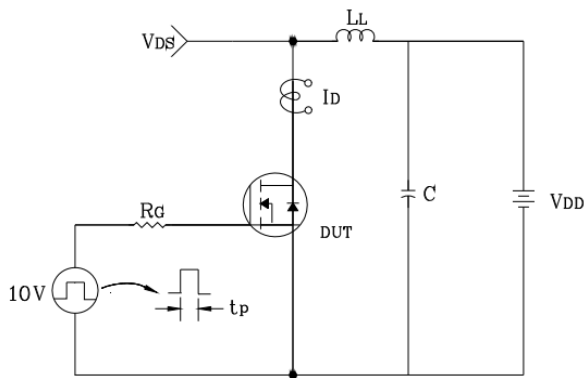

Fig.14- EAS Test Circuit & Waveform

NSS085N100S

N-channel 100V Enhancement Mode Power MOSFET



Typical Characteristics Curves

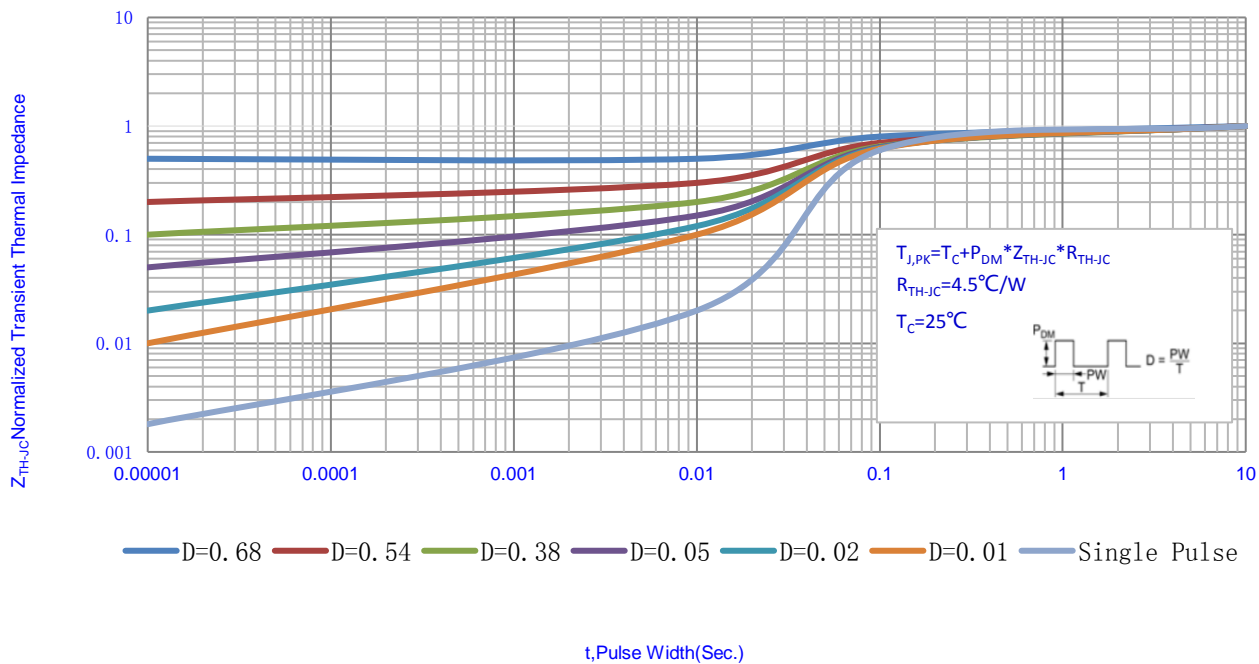

Fig.13- Normalized Transient Thermal Impedance vs. Pulse Width

NSS085N100S



N-channel 100V Enhancement Mode Power MOSFET

OUTLINE DRAWINGS

TO-252

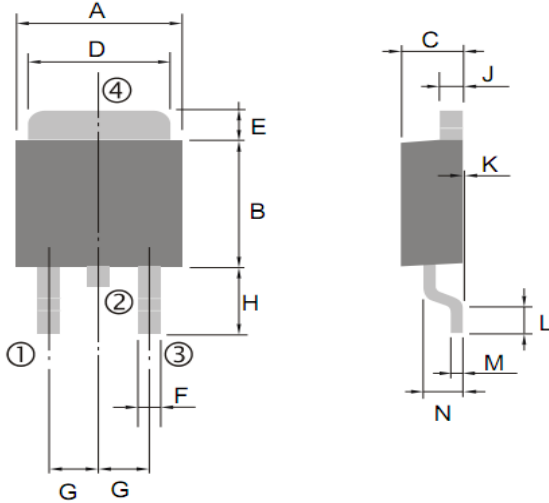

OUTLINE DIMENSIONS

Dim.	Millimeters			Inches		
	Min.	Typ.	Max.	Min.	Typ.	Max.
A	6.400	-	6.800	0.252	-	0.268
B	5.200	-	6.200	0.205	-	0.244
C	2.100	-	2.500	0.083	-	0.098
D	4.800	-	5.500	0.189	-	0.217
E	1.000	-	1.600	0.039	-	0.063
F	0.500	-	1.000	0.020	-	0.039
G	2.100	-	2.500	0.083	-	0.098
H	2.800	-	3.500	0.110	-	0.138
J	0.400	-	0.600	0.016	-	0.024
K	-	0.080	-	-	0.003	-
L	0.900	-	1.400	0.035	-	0.055
M	-	0.500	-	-	0.020	-
N	1.300	-	1.800	0.051	-	0.071

RECOMMENDED LAYOUT DRAWINGS

TO-252

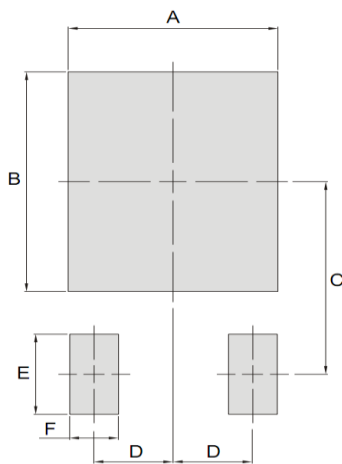

RECOMMENDED LAYOUT DIMENSIONS

Dim.	Millimeters			Inches		
	Min.	Typ.	Max.	Min.	Typ.	Max.
A	-	6.09	-	-	0.24	-
B	-	7.57	-	-	0.298	-
C	-	6.64	-	-	0.261	-
D	-	2.3	-	-	0.091	-
E	-	2.76	-	-	0.109	-
F	-	1.42	-	-	0.056	-

PACKING INFORMATION

TO-252

Package Method	Reel Size (mm)	Quantity (pcs/reel)	Inner Box Size LxWxH(mm)	Quantity (pcs/Inner Box)	Outer Carton Size LxWxH(mm)	Quantity (pcs/carton)
Tape Reel	Φ330	2500	340x340x50	5000	360x360x260	25000



NSS085N100S

N-channel 100V Enhancement Mode Power MOSFET



Recommended wave soldering condition

Product	Peak Temperature	Soldering Time
Pb-free devices	260 +0/-5 °C	5 +1/-1 seconds

Recommended temperature profile for IR reflow

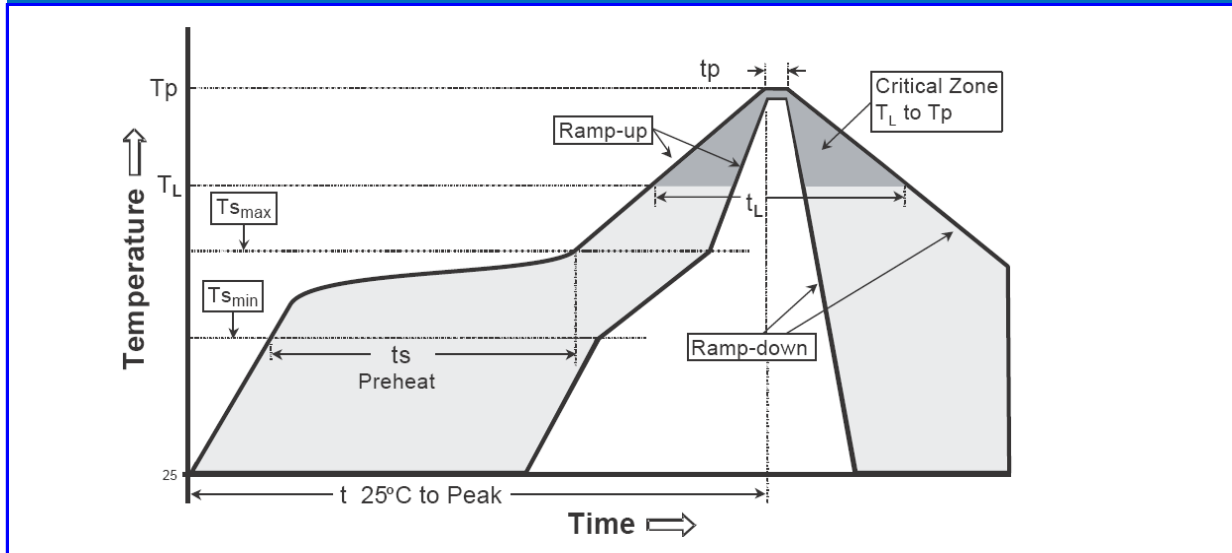

Profile feature	Sn-Pb eutectic Assembly	Pb-free Assembly
Average ramp-up rate (T _{smax} to T _p)	3°C/second max.	3°C/second max.
Preheat -Temperature Min(T _{S min}) -Temperature Max(T _{S max}) -Time(t _{s min} to t _{s max})	100°C 150°C 60-120 seconds	150°C 200°C 60-180 seconds
Time maintained above: -Temperature (T _L) - Time (t _L)	183°C 60-150 seconds	217°C 60-150 seconds
Peak Temperature(T _P)	240 +0/-5 °C	260 +0/-5 °C
Time within 5°C of actual peak temperature(t _p)	10-40 seconds	20-40 seconds
Ramp down rate	6°C/second max.	6°C/second max.
Time 25 °C to peak temperature	6 minutes max.	8 minutes max.

Note : All temperatures refer to topside of the package, measured on the package body surface.

NSS085N100S

N-channel 100V Enhancement Mode Power MOSFET



Disclaimer

- Reproducing and modifying information of the document is prohibited without permission from niuhang Electronics co., LTD
- Niuhan Electronics co., LTD. reserves the rights to make changes of the content herein the document anytime without notification.
- Niuhan Electronics co., LTD. disclaims any and all liability arising out of the application or use of any product including damages incidentally and consequentially occurred.
- Niuhan Electronics co., LTD. does not assume any and all implied warranties, including warranties of fitness for particular purpose, non-infringement and merchantability.
- Applications shown on the herein document are examples of standard use and operation. Customers are responsible in comprehending the suitable use in particular applications. Niuhan Electronics co., LTD. makes no representation or warranty that such applications will be suitable for the specified use without further testing or modification.
- The products shown herein are not designed and authorized for equipments requiring high level of reliability or relating to human life and for any applications concerning life-saving or life-sustaining, such as medical instruments, transportation equipment, aerospace machinery et cetera. Customers using or selling these products for use in such applications do so at their own risk and agree to fully indemnify Niuhan Electronics co., LTD. for any damages resulting from such improper use or sale.
- When the appearance of the product and chip size does not change, in order to product the customer quality, change the internal structure and the production process Niuhan can not notify