

Material :

Nylon 66 UL 94V-0 Black Color

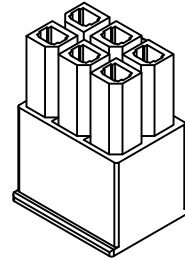
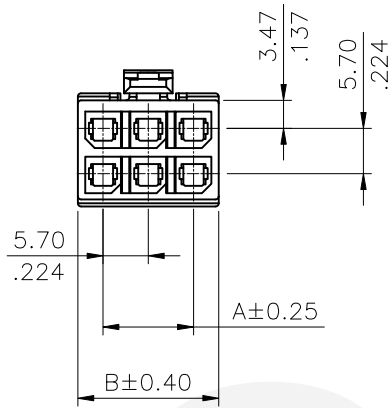

Ordering Code:

CP60 ** S N01 0
 ① ② ③ ④ ⑤

- ① Series No.
- ② No. of Circuits: 02~12 Pin
- ③ Type: S= Housing
- ④ Color: N01= Black Color
- ⑤ Other options: 0= Standard

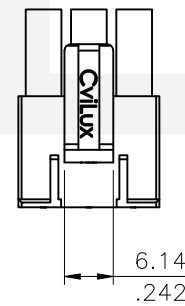
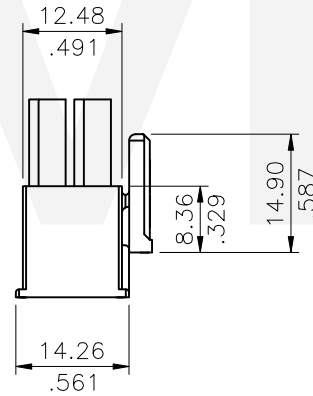
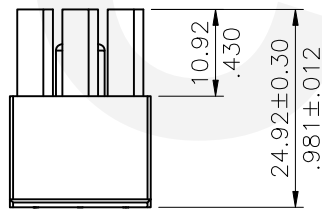

Circuits	Dimension	
	A	B
2	-	8.35(.329)
4	5.70(.224)	12.05(.474)
6	11.40(.449)	17.75(.699)
8	17.10(.673)	23.45(.923)
10	22.80(.898)	29.15(1.148)
12	28.50(1.122)	34.85(1.372)

RoHS Compliant

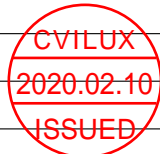

④					DATE	UNIT: mm / inch	TITLE:	 瀚荃股份有限公司 CviLux Corporation
③				DRAWN BY: Clark	11/19-19'	TOLERANCE UNLESS OTHERWISE SPECIFIED	MATERIAL:	
②				ENGINEER: Clark	11/19-19'	.X ± 0.30/.012 X' ± r	FINISH:	
①	Clark	07/16-19	ECNT119180	CHECKED BY: Eisley	12/13-19'	.XX ± 0.25/.010 .X' ±		
SYM	NAME	DATE	REVISIONS	APPROVED BY: Eisley	12/13-19'	.XXX ± 0.15/.006 .XX' ±		DRAWING NO. CP6003SA PART NO. CP60**SN010 SCALE 1 / 1 SHEET 1 OF 2

02 PIN

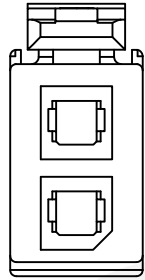

06 PIN

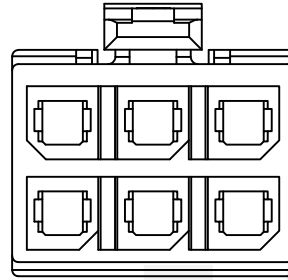

10 PIN

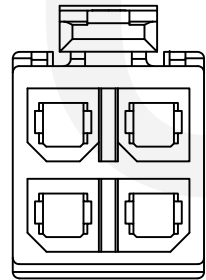
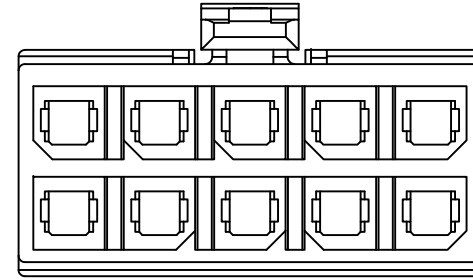

04 PIN

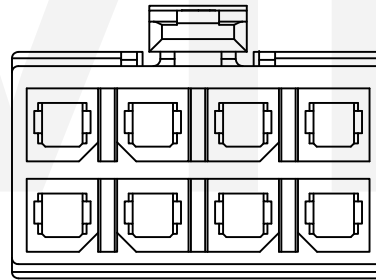

08PIN

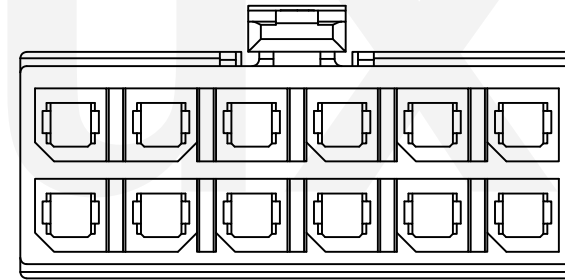

12 PIN

RoHS Compliant

CVILUX
2020.02.10
ISSUED

4					DATE	UNIT: mm / inch	TITLE:	 瀚荃股份有限公司 CviLux Corporation			
3				DRAWN BY: Clark	11/19-19'	TOLERANCE UNLESS OTHERWISE SPECIFIED	MATERIAL:				
2				ENGINEER: Clark	11/19-19'	.X ± 0.30/.012 .X' ± r	FINISH:				
1	Clark	07/16-19	ECNT119180	CHECKED BY: Eisley	12/13-19'	.XX ± 0.25/.010 .X' ±					
SYM	NAME	DATE	REVISIONS	APPROVED BY: Eisley	12/13-19'	.XXX ± 0.15/.006 .XX' ±	DRAWING NO. CP6003SA	PART NO. CP60**SN010			
								SCALE	1 / 1	SHEET	2 OF 2