

High Power LED Series 3535 Ceramic Hot Binning

LH351C

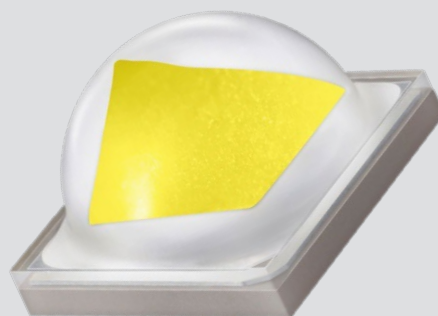

High efficacy and high quality color rendering makes the LH351C suitable use in a broad range of applications

Features & Benefits

- Operates at a maximum current of up to 2 A
- Uniform light distribution under any beam angle
- 90 CRI makes it well suited for most applications
- Hot binning @ 85 °C

Applications

- Indoor Lighting: Spotlight, Downlight
- Outdoor Lighting: Street Light, Tunnel Light, Security Light, Area Light, Stadium/Arena Light
- Industrial Lighting: High Bay Light, Low Bay Light
- Consumer Lighting: Torch Light



SAMSUNG

Table of Contents

1.	Characteristics	-----	3
2.	Product Code Information	-----	6
3.	Typical Characteristics Graphs	-----	16
4.	Outline Drawing & Dimension	-----	18
5.	Reliability Test Items & Conditions	-----	19
6.	Soldering Conditions	-----	20
7.	Tape & Reel	-----	21
8.	Label Structure	-----	23
9.	Packing Structure	-----	24
10.	Precautions in Handling & Use	-----	26

1. Characteristics

a) Absolute Maximum Rating

Item	Symbol	Rating	Unit	Condition
Operating Temperature	T_{opr}	-40 ~ +105	°C	Note 1)*
Storage Temperature	T_{stg}	-40 ~ +120	°C	-
LED Junction Temperature	T_j	150	°C	-
Forward Current	I_F	2000	mA	-
Peak Pulse Forward Current	I_{FP}	2600	mA	Duty 1/10 pulse width 10ms
Assembly Process Temperature		260 <10	°C s	-
ESD (HBM)	-	±8	kV	-

Notes:

- 1) Refer to the derating curve, '3. Typical Characteristics Graph', for proper driving current that maintained below maximum junction temperature.

b) Electro-optical Characteristics

Item	Unit	Condition		Value		
		I _F (mA)	T _J (°C)	Min	Typ	Max
Forward voltage	V	700	85	2.6		3.1
Reverse Voltage (@ 5 mA)	V		25	11		15
Thermal Resistance (junction to solder point)	°C/W		25		3	
Beam Angle	°	700	25		128	

Notes:

- 1) Samsung maintains measurement tolerance of: luminous flux = $\pm 7\%$, forward voltage = ± 0.1 V
- 2) Characteristics @ 25 °C are for reference only

c) Luminous Flux Characteristics (T_j = 85 °C)

Sorting @ 700 mA (lm)			Calculated Minimum Flux ²⁾ (lm)				
Flux Rank	Flux Range ¹⁾	Sub Rank	@ 350 mA	@ 700 mA	@ 1050 mA	@ 1500 mA	@ 2000 mA
FF	150 ~ 210	FB, GB, HB	81	150	213	284	354
GF	170 ~ 230	GB, HB, JB	92	170	241	322	401
HF	190 ~ 250	HB, JB, KB	103	190	269	360	448
JF	210 ~ 270	JB, KB, MB	114	210	298	398	495
KF	230 ~ 290	KB, MB, NB	124	230	326	436	542
MF	250 ~ 310	MB, NB, PB	135	250	354	474	590
NF	270 ~ 330	NB, PB, QB	146	270	383	512	637
PF	290 ~ 350	PB, QB, RB	157	290	411	550	684
QF	310 ~ 370	QB, RB, SB	168	310	439	587	731
RF	330 ~ 390	RB, SB, TB	178	330	468	625	778
SF	350 ~ 410	SB, TB, UB	189	350	496	663	825
TF	370 ~ 430	TB, UB, VB	200	370	524	701	872
UF	390 ~ 450	UB, VB, WB	211	390	553	739	920
VF	410 ~ 470	VB, WB, YB	222	410	581	777	967
WF	430 ~ 490	WB, YB, ZB	232	430	609	815	1,014

Notes:

- 1) Samsung maintains measurement tolerance of: luminous flux = $\pm 7\%$, CRI = ± 3
- 2) Calculated minimum flux values at 350/1050/1500/2000mA are for reference only.

2. Product Code Information

1	2	3	4	5	6	7	8	9	10	11	12	13	14	15	16	17	18
S	P	H	W	H	T	L	3	D	5	0	C	E	4	R	T	P	F

Digit	PKG Information	Code	Specification	
1 2 3	Samsung Package High Power	SPH		
4 5	Color	WH	White	
6	Product Version	T		
7 8	Product	L3	LH351 Series	
9	Lens Type	D	Dome lens	
10	Internal Code	5	LH351C	
11	Not Defined	0	Default	
12	CRI & Sorting Temperature	C D E G	Min. 70 Min. 75 Min. 80 Min. 90	85℃
13 14	Forward Voltage (V)	E 4	2.6~3.1	Bin Code: E2 2.6~2.9 G2 2.9~3.1
15 16	CCT (K)	Y ☆ W ☆ V ☆ U ☆ T ☆ R ◇ Q ◇ P ◇	2200 2700 3000 3500 4000 5000 5700 6500	Y1, Y2, Y3, Y4, Y5, Y6, Y7, Y8, Y9, YA, YB, YC, YD, YE, YF, YG, YM W1, W2, W3, W4, W5, W6, W7, W8, W9, WA, WB, WC, WD, WE, WF, WG, WM V1, V2, V3, V4, V5, V6, V7, V8, V9, VA, VB, VC, VD, VE, VF, VG, VM U1, U2, U3, U4, U5, U6, U7, U8, U9, UA, UB, UC, UD, UE, UF, UG, UM T1, T2, T3, T4, T5, T6, T7, T8, T9, TA, TB, TC, TD, TE, TF, TG, TM R1, R2, R3, R4, RN Q1, Q2, Q3, Q4, QN P1, P2, P3, P4, PN ☆ : "0" (Whole bin), "P" (Quarter bin), or "M" (MacAdam 3-step ellipse bin) ◇ : "T" (Half bin), "N" (MacAdam 5-step ellipse bin)
17 18	Luminous Flux (lm)	FF GF HF JF KF MF NF PF QF RF	150 ~ 210 170 ~ 230 190 ~ 250 210 ~ 270 230 ~ 290 250 ~ 310 270 ~ 330 290 ~ 350 310 ~ 370 330 ~ 390	FB 150 ~ 170 GB 170 ~ 190 HB 190 ~ 210 JB 210 ~ 230 KB 230 ~ 250 MB 250 ~ 270 NB 270 ~ 290 PB 290 ~ 310 QB 310 ~ 330 RB 330 ~ 350 SB 350 ~ 370 TB 370 ~ 390
			Digit 17: Min. spec. Digit 18: The number of higher bin(s) from min. spec. e.g.: KB = 230~250 lm, KF = 230~290 lm	

a) Luminous Flux Bins ($I_f = 700 \text{ mA}$, $T_j = 85 \text{ °C}$)

CRI/ Nominal CCT (K)	Flux rank												
	FB	GB	HB	JB	KB	MB	NB	PB	QB	RB	SB	TB	
	(min. flux)	150	170	190	210	230	250	270	290	310	330	350	370
70	2200						SPHWHTL3D50CE4Y☆MF						
	2700						SPHWHTL3D50CE4W☆NF						
								SPHWHTL3D50CE4V☆PF					
	3000						SPHWHTL3D50CE4V☆NF						
								SPHWHTL3D50CE4V☆PF					
	3500							SPHWHTL3D50CE4U☆PF					
								SPHWHTL3D50CE4U☆QF					
	4000							SPHWHTL3D50CE4T☆QF					
								SPHWHTL3D50CE4T☆RF					
	5000							SPHWHTL3D50CE4R◇PF					
								SPHWHTL3D50CE4R◇QF					
	5700							SPHWHTL3D50CE4R◇RF					
							SPHWHTL3D50CE4Q◇QF						
6500							SPHWHTL3D50CE4Q◇RF						
							SPHWHTL3D50CE4P◇PF						
75	3000						SPHWHTL3D50CE4P◇QF						
	3500						SPHWHTL3D50DE4V☆PF						
								SPHWHTL3D50DE4U☆PF					
	4000						SPHWHTL3D50DE4T☆PF						
								SPHWHTL3D50DE4R◇PF					
	5000						SPHWHTL3D50DE4R◇QF						
5700						SPHWHTL3D50DE4Q◇PF							
							SPHWHTL3D50DE4Q◇QF						

"☆" can be "0" (Whole bin), "P" (Quarter bin), or "M" (MacAdam 3-step ellipse bin) of the color binning

"◇" can be "T" (Half bin), "N" (MacAdam 5-step ellipse bin) of the color binning

a) Luminous Flux Bins ($I_f = 700 \text{ mA}$, $T_j = 85 \text{ °C}$)

CRI/ Nominal CCT (K)	Flux rank												
	FB	GB	HB	JB	KB	MB	NB	PB	QB	RB	SB	TB	
	(min. flux)	150	170	190	210	230	250	270	290	310	330	350	370
80	2700						SPHWHTL3D50EE4W ☆MF						
							SPHWHTL3D50EE4W ☆NF						
	3000						SPHWHTL3D50EE4V ☆NF						
								SPHWHTL3D50EE4V ☆PF					
	3500						SPHWHTL3D50EE4U ☆NF						
								SPHWHTL3D50EE4U ☆PF					
	4000							SPHWHTL3D50EE4T ☆PF					
									SPHWHTL3D50EE4T ☆QF				
	5000								SPHWHTL3D50EE4R ☆PF				
									SPHWHTL3D50EE4R ☆QF				
5700								SPHWHTL3D50EE4Q ☆PF					
								SPHWHTL3D50EE4Q ☆QF					

"☆" can be "O" (Whole bin), "P" (Quarter bin), or "M" (MacAdam 3-step ellipse bin) of the color binning

"◇" can be "T" (Half bin), "N" (MacAdam 5-step ellipse bin) of the color binning

a) Luminous Flux Bins ($I_f = 700 \text{ mA}$, $T_j = 85 \text{ }^\circ\text{C}$)

CRI/ Nominal CCT (K)	Flux rank											
	FB	GB	HB	JB	KB	MB	NB	PB	QB	RB	SB	TB
(min. flux)	150	170	190	210	230	250	270	290	310	330	350	370
2700			SPHWHTL3D50GE4W☆HF									
				SPHWHTL3D50GE4W☆JF								
3000				SPHWHTL3D50GE4V☆JF								
				SPHWHTL3D50GE4U☆JF								
3500				SPHWHTL3D50GE4U☆KF								
90				SPHWHTL3D50GE4T☆JF								
4000				SPHWHTL3D50GE4T☆KF								
				SPHWHTL3D50GE4R◇KF								
5000				SPHWHTL3D50GE4R◇MF								
				SPHWHTL3D50GE4Q◇KF								
5700				SPHWHTL3D50GE4Q◇MF								

"☆" can be "O" (Whole bin), "P" (Quarter bin), or "M" (MacAdam 3-step ellipse bin) of the color binning

"◇" can be "T" (Half bin), "N" (MacAdam 5-step ellipse bin) of the color binning

b) Color Bins (I_F = 700 mA, T_J = 85 °C)

Nominal CCT (K)	CRI (R _a)	Color Rank	Chromaticity Bins
2200	70	☆0 (Whole bin)	1, 2, 3, 4, 5, 6, 7, 8, 9, A, B, C, D, E, F, G
		☆P (Quarter bin)	6, 7, A, B
		☆M (MacAdam 3-step)	MacAdam 3-step
2700	70, 80, 90	☆0 (Whole bin)	1, 2, 3, 4, 5, 6, 7, 8, 9, A, B, C, D, E, F, G
		☆P (Quarter bin)	6, 7, A, B
		☆M (MacAdam 3-step)	MacAdam 3-step
3000, 3500, 4000	70, 80, 90	☆0 (Whole bin)	1, 2, 3, 4, 5, 6, 7, 8, 9, A, B, C, D, E, F, G
		☆P (Quarter bin)	6, 7, A, B
		☆M (MacAdam 3-step)	MacAdam 3-step
	75	☆0 (Whole bin)	1, 2, 3, 4, 5, 6, 7, 8, 9, A, B, C, D, E, F, G
5000, 5700	70, 75, 80, 90	☆T (Half bin)	1, 2, 3, 4
		☆N (MacAdam 5-step)	MacAdam 5-step
6500	70	☆T (Half bin)	1, 2, 3, 4
		☆N (MacAdam 5-step)	MacAdam 5-step

c) Voltage Bins (I_F = 700 mA, T_J = 85 °C)

Nominal CCT (K)	CRI (R _a) Min.	Product Code	Voltage Rank	Voltage Bin	Voltage Range (V)
-	-	-	E4	E2	2.6 ~ 2.9
-	-	-	-	G2	2.9 ~ 3.1

d) Chromaticity Region & Coordinates ($I_f = 700 \text{ mA}$, $T_j = 85 \text{ }^\circ\text{C}$)

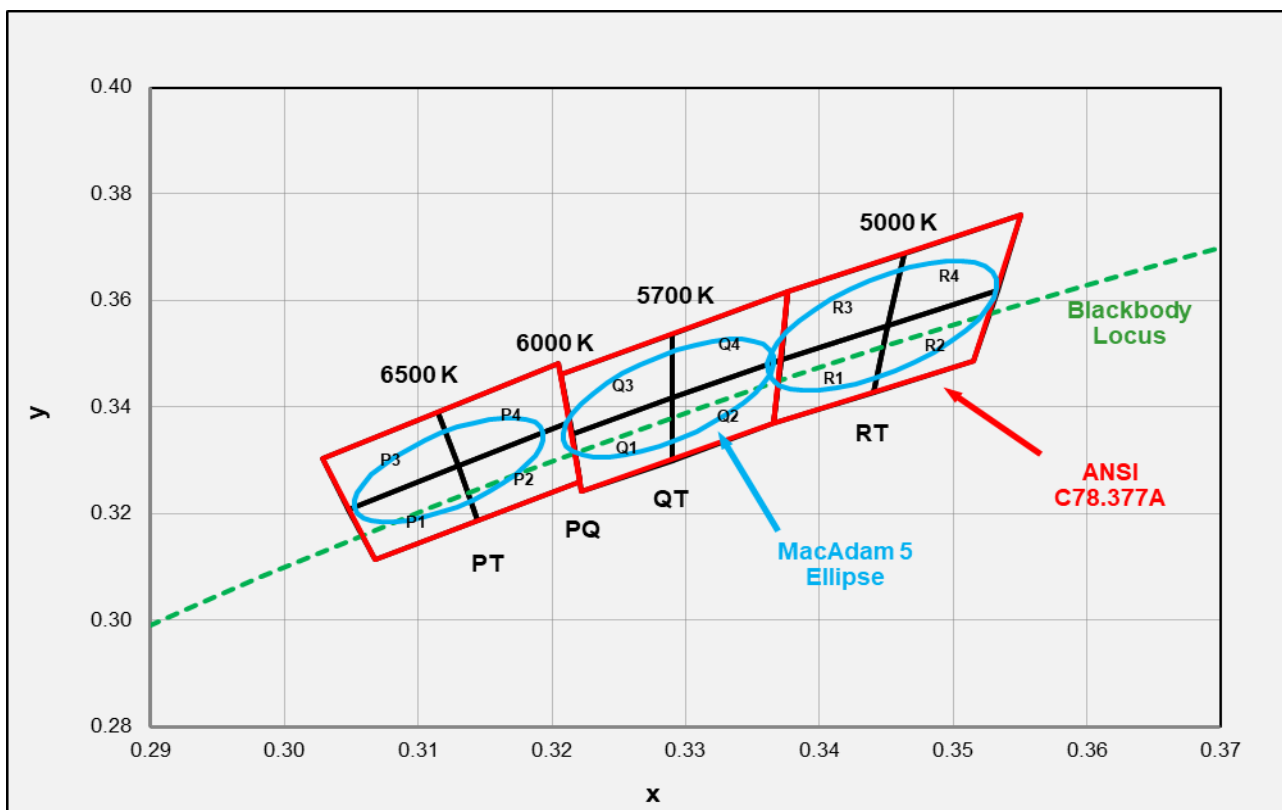
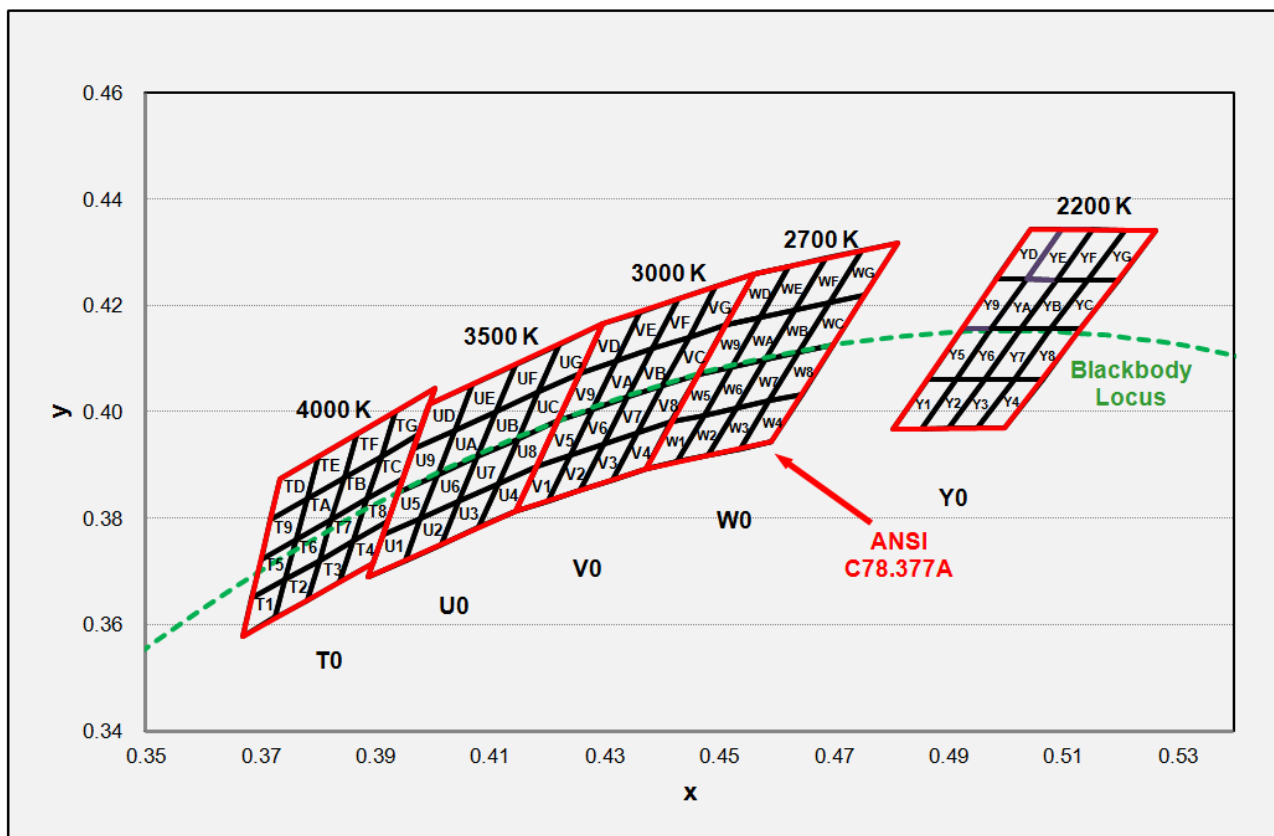

d) Chromaticity Region & Coordinates ($I_f = 700 \text{ mA}$, $T_j = 85 \text{ }^\circ\text{C}$)

Region	CIE x	CIE y	Region	CIE x	CIE y
Y rank (2200 K)					
Y1	0.4805	0.3968	Y9	0.4925	0.4156
	0.4854	0.3968		0.4976	0.4156
	0.4915	0.4062		0.5038	0.4250
	0.4865	0.4062		0.4984	0.4250
Y2	0.4854	0.3968	YA	0.4976	0.4156
	0.4903	0.3969		0.5028	0.4156
	0.4966	0.4062		0.5091	0.4249
	0.4915	0.4062		0.5038	0.4250
Y3	0.4903	0.3969	YB	0.5028	0.4156
	0.4952	0.3969		0.5080	0.4156
	0.5016	0.4062		0.5145	0.4249
	0.4966	0.4062		0.5091	0.4249
Y4	0.4952	0.3969	YC	0.5080	0.4156
	0.5000	0.3969		0.5132	0.4156
	0.5066	0.4062		0.5198	0.4249
	0.5016	0.4062		0.5145	0.4249
Y5	0.4865	0.4062	YD	0.4984	0.4250
	0.4915	0.4062		0.5038	0.4250
	0.4976	0.4156		0.5099	0.4344
	0.4925	0.4156		0.5044	0.4344
Y6	0.4915	0.4062	YE	0.5038	0.4250
	0.4966	0.4062		0.5091	0.4249
	0.5028	0.4156		0.5154	0.4343
	0.4976	0.4156		0.5099	0.4344
Y7	0.4966	0.4062	YF	0.5091	0.4249
	0.5016	0.4062		0.5145	0.4249
	0.508	0.4156		0.5209	0.4342
	0.5028	0.4156		0.5154	0.4343
Y8	0.5016	0.4062	YG	0.5145	0.4249
	0.5066	0.4062		0.5198	0.4249
	0.5132	0.4156		0.5264	0.4342
	0.5080	0.4156		0.5209	0.4342

Region	CIE x	CIE y	Region	CIE x	CIE y
W rank (2700 K)					
W1	0.4373	0.3893	W9	0.4465	0.4071
	0.4418	0.3981		0.4513	0.4164
	0.4475	0.3994		0.4573	0.4178
	0.4428	0.3906		0.4523	0.4085
W2	0.4428	0.3906	WA	0.4523	0.4085
	0.4475	0.3994		0.4573	0.4178
	0.4532	0.4008		0.4634	0.4193
	0.4483	0.3919		0.4582	0.4099
W3	0.4483	0.3919	WB	0.4582	0.4099
	0.4532	0.4008		0.4634	0.4193
	0.4589	0.4021		0.4695	0.4207
	0.4538	0.3931		0.4641	0.4112
W4	0.4538	0.3931	WC	0.4641	0.4112
	0.4589	0.4021		0.4695	0.4207
	0.4646	0.4034		0.4756	0.4221
	0.4593	0.3944		0.4700	0.4126
W5	0.4418	0.3981	WD	0.4513	0.4164
	0.4465	0.4071		0.4562	0.4260
	0.4523	0.4085		0.4624	0.4274
	0.4475	0.3994		0.4573	0.4178
W6	0.4475	0.3994	WE	0.4573	0.4178
	0.4523	0.4085		0.4624	0.4274
	0.4582	0.4099		0.4687	0.4289
	0.4532	0.4008		0.4634	0.4193
W7	0.4532	0.4008	WF	0.4634	0.4193
	0.4582	0.4099		0.4687	0.4289
	0.4641	0.4112		0.4750	0.4304
	0.4589	0.4021		0.4695	0.4207
W8	0.4589	0.4021	WG	0.4695	0.4207
	0.4641	0.4112		0.4750	0.4304
	0.4700	0.4126		0.4813	0.4319
	0.4646	0.4034		0.4756	0.4221

d) Chromaticity Region & Coordinates

Region	CIE x	CIE y	Region	CIE x	CIE y
V rank (3000 K)					
V1	0.4147	0.3814	V9	0.4221	0.3984
	0.4183	0.3898		0.4259	0.4073
	0.4242	0.3919		0.4322	0.4096
	0.4203	0.3833		0.4281	0.4006
V2	0.4203	0.3833	VA	0.4281	0.4006
	0.4242	0.3919		0.4322	0.4096
	0.4300	0.3939		0.4385	0.4119
	0.4259	0.3853		0.4342	0.4028
V3	0.4259	0.3853	VB	0.4342	0.4028
	0.4300	0.3939		0.4385	0.4119
	0.4359	0.3960		0.4449	0.4141
	0.4316	0.3873		0.4403	0.4049
V4	0.4316	0.3873	VC	0.4403	0.4049
	0.4359	0.3960		0.4449	0.4141
	0.4418	0.3981		0.4513	0.4164
	0.4373	0.3893		0.4465	0.4071
V5	0.4183	0.3898	VD	0.4259	0.4073
	0.4221	0.3984		0.4299	0.4165
	0.4281	0.4006		0.4364	0.4188
	0.4242	0.3919		0.4322	0.4096
V6	0.4242	0.3919	VE	0.4322	0.4096
	0.4281	0.4006		0.4364	0.4188
	0.4342	0.4028		0.4430	0.4212
	0.4300	0.3939		0.4385	0.4119
V7	0.4300	0.3939	VF	0.4385	0.4119
	0.4342	0.4028		0.4430	0.4212
	0.4403	0.4049		0.4496	0.4236
	0.4359	0.3960		0.4449	0.4141
V8	0.4359	0.3960	VG	0.4449	0.4141
	0.4403	0.4049		0.4496	0.4236
	0.4465	0.4071		0.4562	0.4260
	0.4418	0.3981		0.4513	0.4164

Region	CIE x	CIE y	Region	CIE x	CIE y
U rank (3500 K)					
U1	0.3889	0.3690	U9	0.3941	0.3848
	0.3915	0.3768		0.3968	0.3930
	0.3981	0.3800		0.4040	0.3966
	0.3953	0.3720		0.4010	0.3882
U2	0.3953	0.3720	UA	0.4010	0.3882
	0.3981	0.3800		0.4040	0.3966
	0.4048	0.3832		0.4113	0.4001
	0.4017	0.3751		0.4080	0.3916
U3	0.4017	0.3751	UB	0.4080	0.3916
	0.4048	0.3832		0.4113	0.4001
	0.4116	0.3865		0.4186	0.4037
	0.4082	0.3782		0.4150	0.3950
U4	0.4082	0.3782	UC	0.4150	0.3950
	0.4116	0.3865		0.4186	0.4037
	0.4183	0.3898		0.4259	0.4073
	0.4147	0.3814		0.4221	0.3984
U5	0.3915	0.3768	UD	0.3968	0.3930
	0.3941	0.3848		0.3996	0.4015
	0.4010	0.3882		0.4071	0.4052
	0.3981	0.3800		0.4040	0.3966
U6	0.3981	0.3800	UE	0.4040	0.3966
	0.4010	0.3882		0.4071	0.4052
	0.4080	0.3916		0.4146	0.4089
	0.4048	0.3832		0.4113	0.4001
U7	0.4048	0.3832	UF	0.4113	0.4001
	0.4080	0.3916		0.4146	0.4089
	0.4150	0.3950		0.4222	0.4127
	0.4116	0.3865		0.4186	0.4037
U8	0.4116	0.3865	UG	0.4186	0.4037
	0.4150	0.3950		0.4222	0.4127
	0.4221	0.3984		0.4299	0.4165
	0.4183	0.3898		0.4259	0.4073

d) Chromaticity Region & Coordinates

Region	CIE x	CIE y	Region	CIE x	CIE y
T rank (4000 K)					
T1	0.3670	0.3578	T9	0.3702	0.3722
	0.3726	0.3612		0.3763	0.3760
	0.3744	0.3685		0.3782	0.3837
	0.3686	0.3649		0.3719	0.3797
T2	0.3726	0.3612	TA	0.3763	0.3760
	0.3783	0.3646		0.3825	0.3798
	0.3804	0.3721		0.3847	0.3877
	0.3744	0.3685		0.3782	0.3837
T3	0.3783	0.3646	TB	0.3825	0.3798
	0.3840	0.3681		0.3887	0.3836
	0.3863	0.3758		0.3912	0.3917
	0.3804	0.3721		0.3847	0.3877
T4	0.3840	0.3681	TC	0.3887	0.3837
	0.3898	0.3716		0.3950	0.3875
	0.3924	0.3794		0.3978	0.3958
	0.3863	0.3758		0.3912	0.3917
T5	0.3686	0.3649	TD	0.3719	0.3797
	0.3744	0.3685		0.3782	0.3837
	0.3763	0.3760		0.3802	0.3916
	0.3702	0.3722		0.3736	0.3874
T6	0.3744	0.3685	TE	0.3782	0.3837
	0.3804	0.3721		0.3847	0.3877
	0.3825	0.3798		0.3869	0.3958
	0.3763	0.3760		0.3802	0.3916
T7	0.3804	0.3721	TF	0.3847	0.3877
	0.3863	0.3758		0.3912	0.3917
	0.3887	0.3836		0.3937	0.4001
	0.3825	0.3798		0.3869	0.3958
T8	0.3863	0.3758	TG	0.3912	0.3917
	0.3924	0.3794		0.3978	0.3958
	0.3950	0.3875		0.4006	0.4044
	0.3887	0.3836		0.3937	0.4001

d) Chromaticity Region & Coordinates

Region	CIE x	CIE y	Region	CIE x	CIE y	Region	CIE x	CIE y
R rank (5000 K)			Q rank (5700 K)			P rank (6500 K)		
R1	0.3371	0.3490	Q1	0.3215	0.3350	P1	0.3068	0.3113
	0.3451	0.3554		0.3290	0.3417		0.3144	0.3186
	0.3440	0.3427		0.3290	0.3300		0.3130	0.3290
	0.3366	0.3369		0.3222	0.3243		0.3048	0.3207
R2	0.3451	0.3554	Q2	0.3290	0.3417	P2	0.3144	0.3186
	0.3533	0.3620		0.3371	0.3490		0.3221	0.3261
	0.3515	0.3487		0.3366	0.3369		0.3213	0.3373
	0.3440	0.3427		0.3290	0.3300		0.3130	0.3290
R3	0.3376	0.3616	Q3	0.3207	0.3462	P3	0.3048	0.3207
	0.3463	0.3687		0.3290	0.3538		0.3130	0.3290
	0.3451	0.3554		0.3290	0.3417		0.3115	0.3391
	0.3371	0.3490		0.3215	0.3350		0.3028	0.3304
R4	0.3463	0.3687	Q4	0.3290	0.3538	P4	0.3130	0.3290
	0.3551	0.3760		0.3376	0.3616		0.3213	0.3373
	0.3533	0.3620		0.3371	0.3490		0.3205	0.3481
	0.3451	0.3554		0.3290	0.3417		0.3115	0.3391

e) MacAdam Ellipse ($I_f = 700 \text{ mA}$, $T_j = 85 \text{ }^\circ\text{C}$)

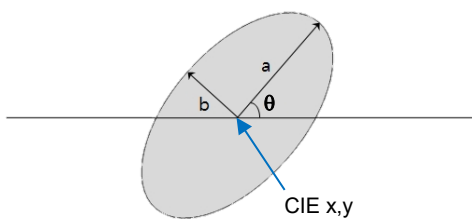

Nom. CCT (K)	Color Rank	Ellipse	Center		Rotation Angle θ ($^\circ$)	a	b
			CIE x	CIE y			
2200	YM	3-step	0.5018	0.4153	53.45	0.0072	0.0040
2700	WM	3-step	0.4578	0.4101	53.70	0.0081	0.0042
3000	VM	3-step	0.4338	0.4030	53.22	0.0083	0.0041
3500	UM	3-step	0.4073	0.3917	54.00	0.0093	0.0041
4000	TM	3-step	0.3818	0.3797	53.72	0.0094	0.0040
5000	RN	5-step	0.3447	0.3553	59.62	0.0137	0.0059
5700	QN	5-step	0.3287	0.3417	59.10	0.0125	0.0053
6500	PN	5-step	0.3123	0.3282	58.57	0.0116	0.0048

Note:

Samsung maintains measurement tolerance of: $C_x, C_y = \pm 0.005$

3. Typical Characteristics Graphs

a) Spectrum Distribution ($I_f = 700 \text{ mA}, T_j = 85 \text{ }^\circ\text{C}$)

Cool White (CRI70)

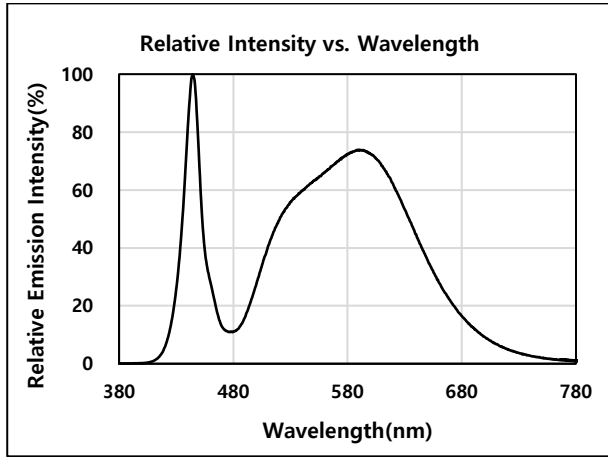

Warm White (CRI80)

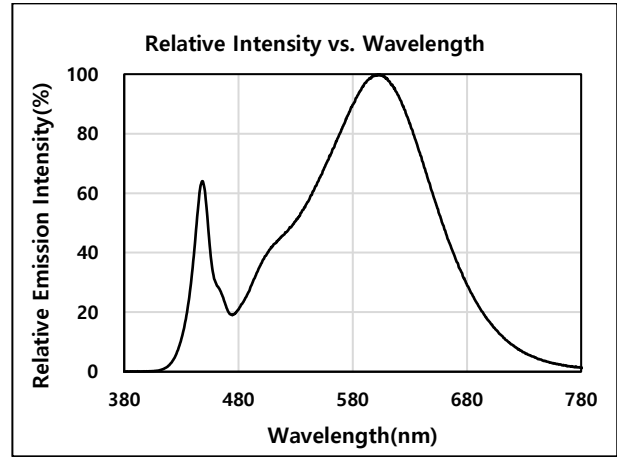

b) Forward Current Characteristics ($T_j = 85 \text{ }^\circ\text{C}$)

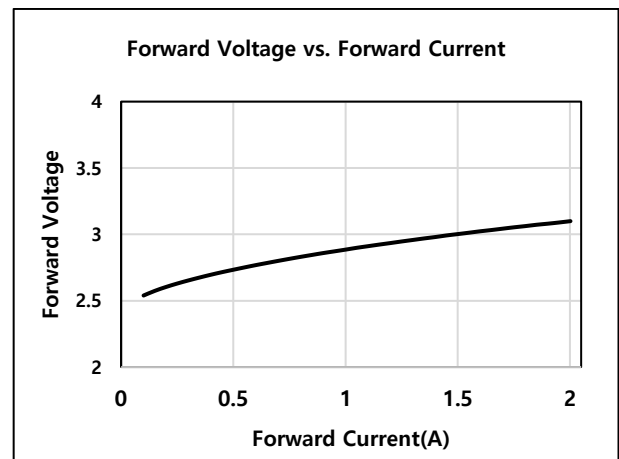
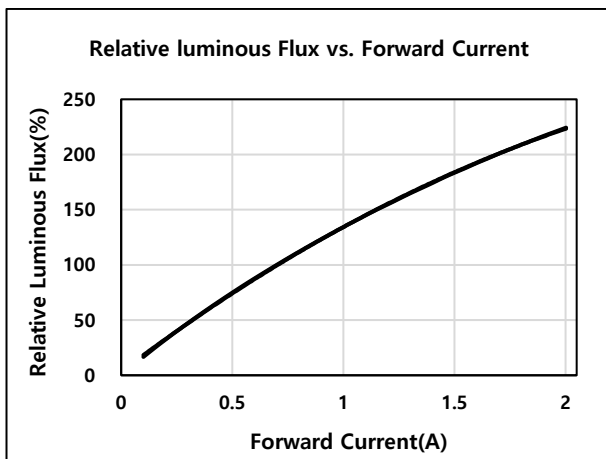

c) Temperature Characteristics ($I_f = 700 \text{ mA}$)

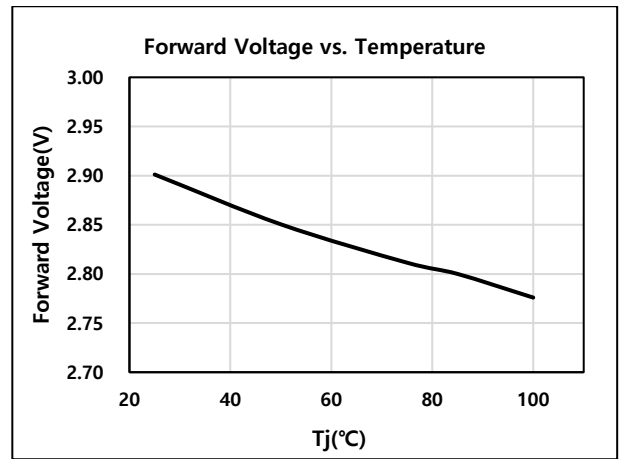
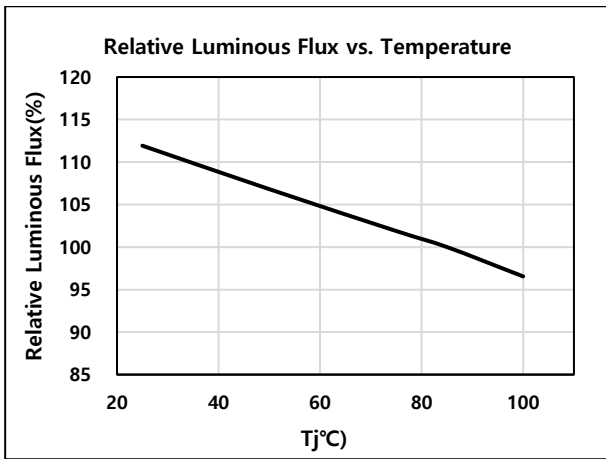

d) Color Shift Characteristics (If = 700 mA, Tj = 85 °C)

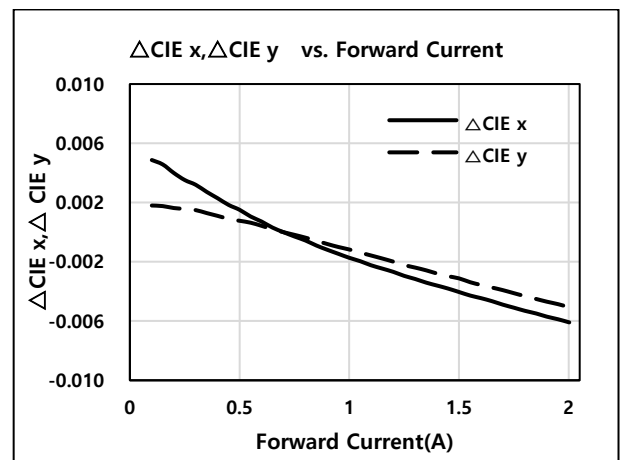
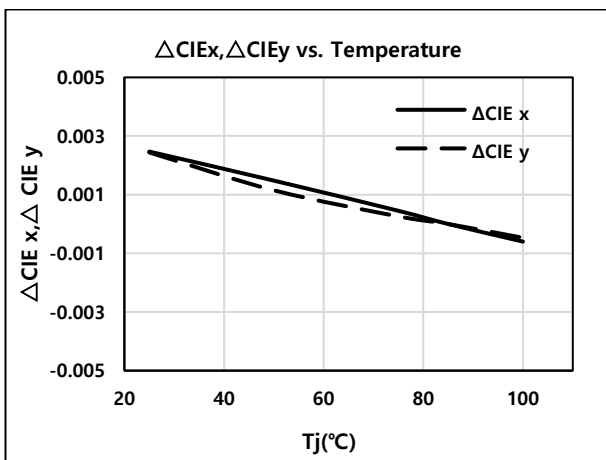

e) Derating Curve and Beam Angle Characteristics (If = 700 mA, Tj = 25 °C)

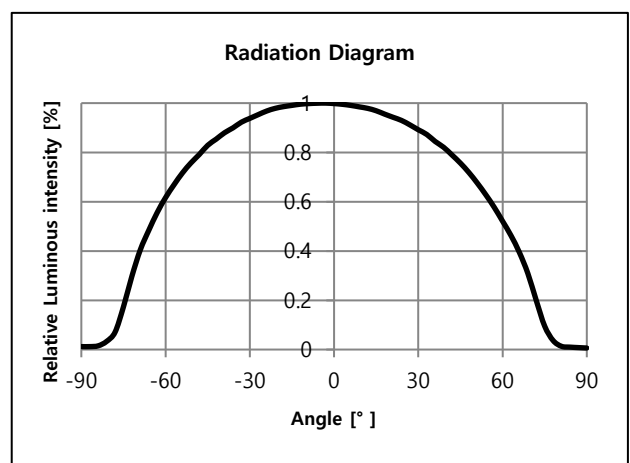
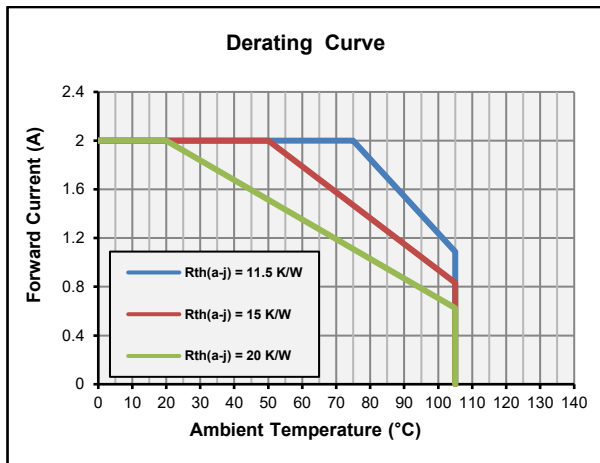

4. Outline Drawing & Dimension

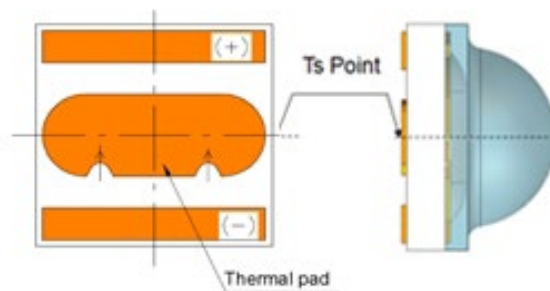
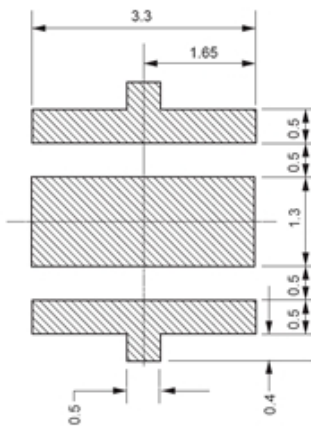
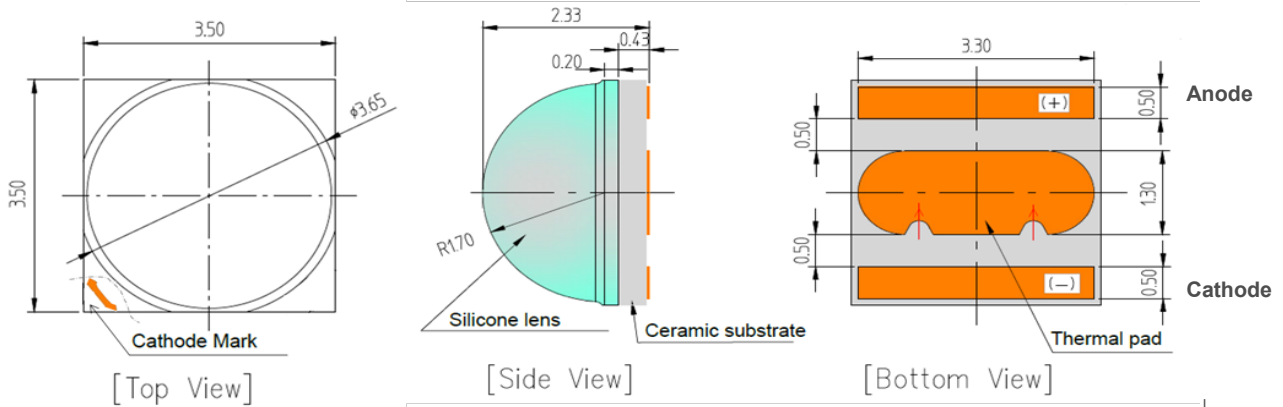

- Measurement unit: mm
- Tolerance: ± 0.13 mm

Recommended Soldering Pattern

Notes:

- 1) This LED has built-in ESD protection device(s) connected in parallel to LED chip(s).
- 2) The thermal pad is electrically isolated from the anode and cathode contact pads.
- 3) T_s point and measurement method:
 - ① Measure the nearest point to thermal pad as shown above. If necessary, remove PSR of PCB to reach T_s point.
 - ② All pads must be soldered to the PCB to dissipate heat properly, otherwise the LED can be damaged.

Precautions:

- 1) Pressure on the LEDs will influence to the reliability of the LEDs. Precautions should be taken to avoid strong pressure on the LEDs. Do not put stress on the LEDs during heating.
- 2) Re-soldering should not be done after the LEDs have been soldered. If re-soldering is unavoidable, LED's characteristics should be carefully checked before and after such repair.
- 3) Do not stack assembled PCBs together. Since materials of LEDs is soft, abrasion between two PCB assembled with LED might cause catastrophic failure of the LEDs.

5. Reliability Test Items & Conditions

a) Test Items

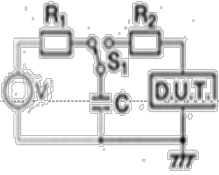
Test Item	Test Condition	Test Hour / Cycle
Room Temperature Life Test	25 °C, Maximum Rated Drive Current	1000 h
High Temperature Life Test	85 °C, Maximum Rated Drive Current	1000 h
High Temperature Humidity Life Test	85 °C, 85 % RH, Maximum Rated Drive Current	1000 h
Low Temperature Life Test	-40 °C, Maximum Rated Drive Current	1000 h
Powered Temperature Cycle	-45 °C / 20 min ↔ 85 °C / 20 min, sweep 100 min cycle on/off: each 5 min, Maximum Rated Drive Current	100 cycles
Temperature Cycling	-45 °C / 15 min ↔ 125 °C / 15 min temperature change within 5 min	500 cycles
High Temperature Storage	120 °C	1000 h
Low Temperature Storage	-40 °C	1000 h
ESD (HBM)	 <p> R_1: 10 MΩ R_2: 1.5 kΩ C: 100 pF V: ± 8 kV </p>	5 times
ESD (MM)	<p> R_1: 10 MΩ R_2: 0 C: 200 pF V: ± 0.8 kV </p>	5 times
Vibration Test	20~2000~20 Hz, 200 m/s ² , sweep 4 min X, Y, Z 3 direction, each 1 cycle	4 cycles

b) Criteria for Judging the Damage

Item	Symbol	Test Condition (T _j = 25 °C)	Limit	
			Min.	Max.
Forward Voltage	V _F	I _F = 700 mA	Init. Value * 0.9	Init. Value * 1.1
Luminous Flux	Φ _v	I _F = 700 mA	Init. Value * 0.7	Init. Value * 1.1

6. Soldering Conditions

a) Reflow Conditions (Pb free)

Reflow frequency: 2 times max.

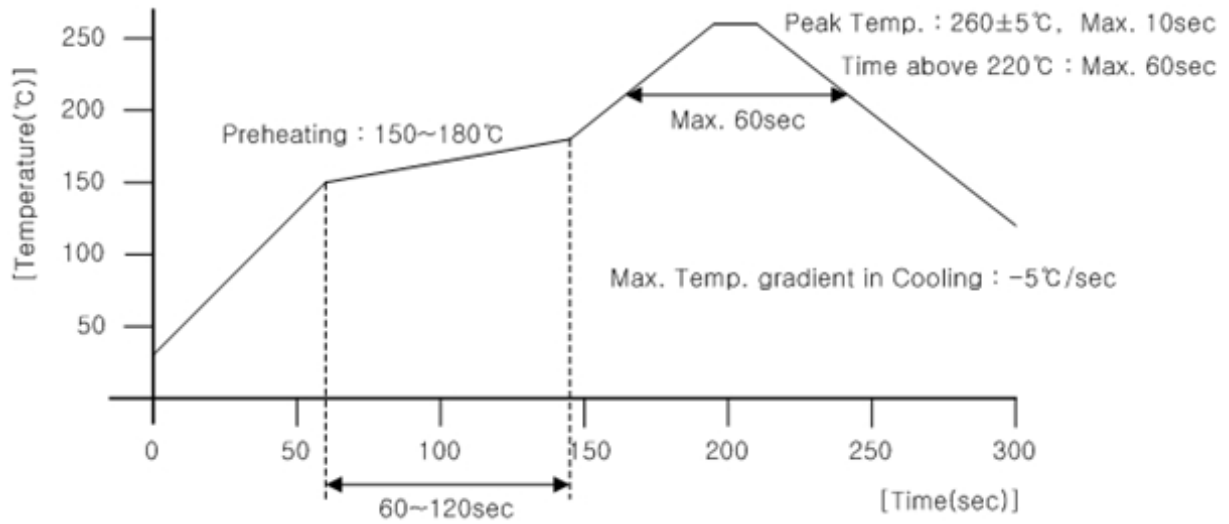

b) Manual Soldering Conditions

Not more than 5 seconds @ max. 300 °C, under soldering iron.

7. Tape & Reel

a) Taping Dimension

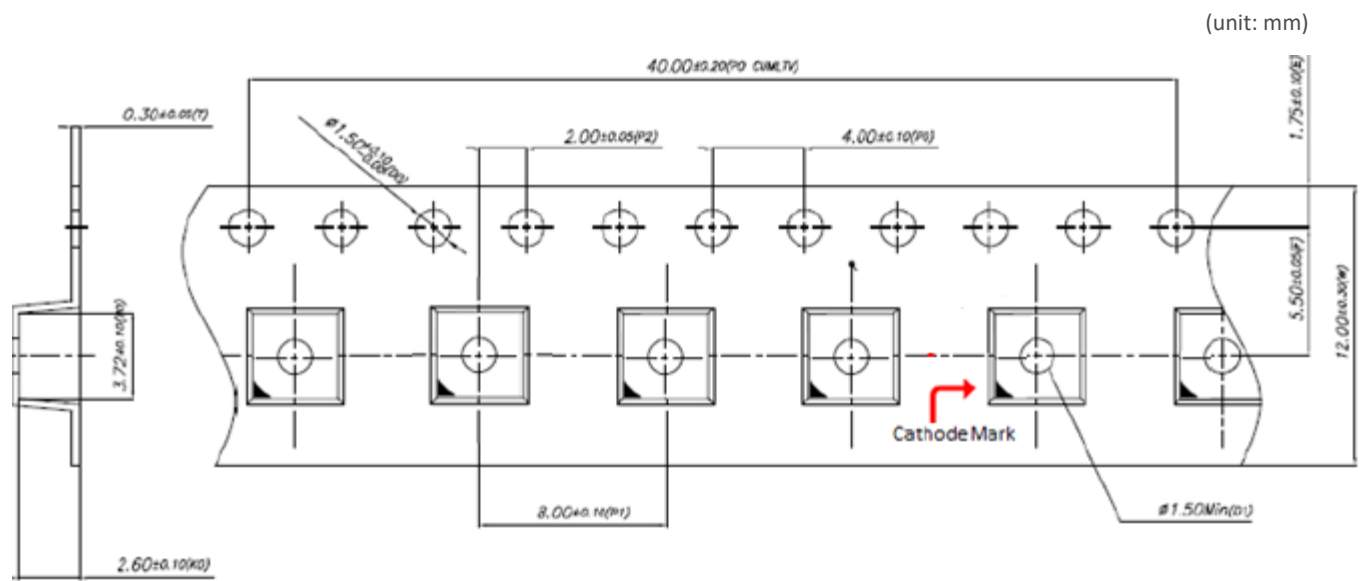

Taping Diretion

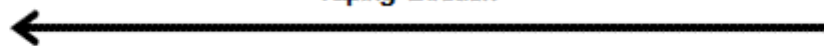

End

Start

More than 40 mm
Unloaded tape

Mounted with
LED package

More than 100~200 mm
Unloaded tape

Leading part more than
200~400 mm

b) Reel Dimension

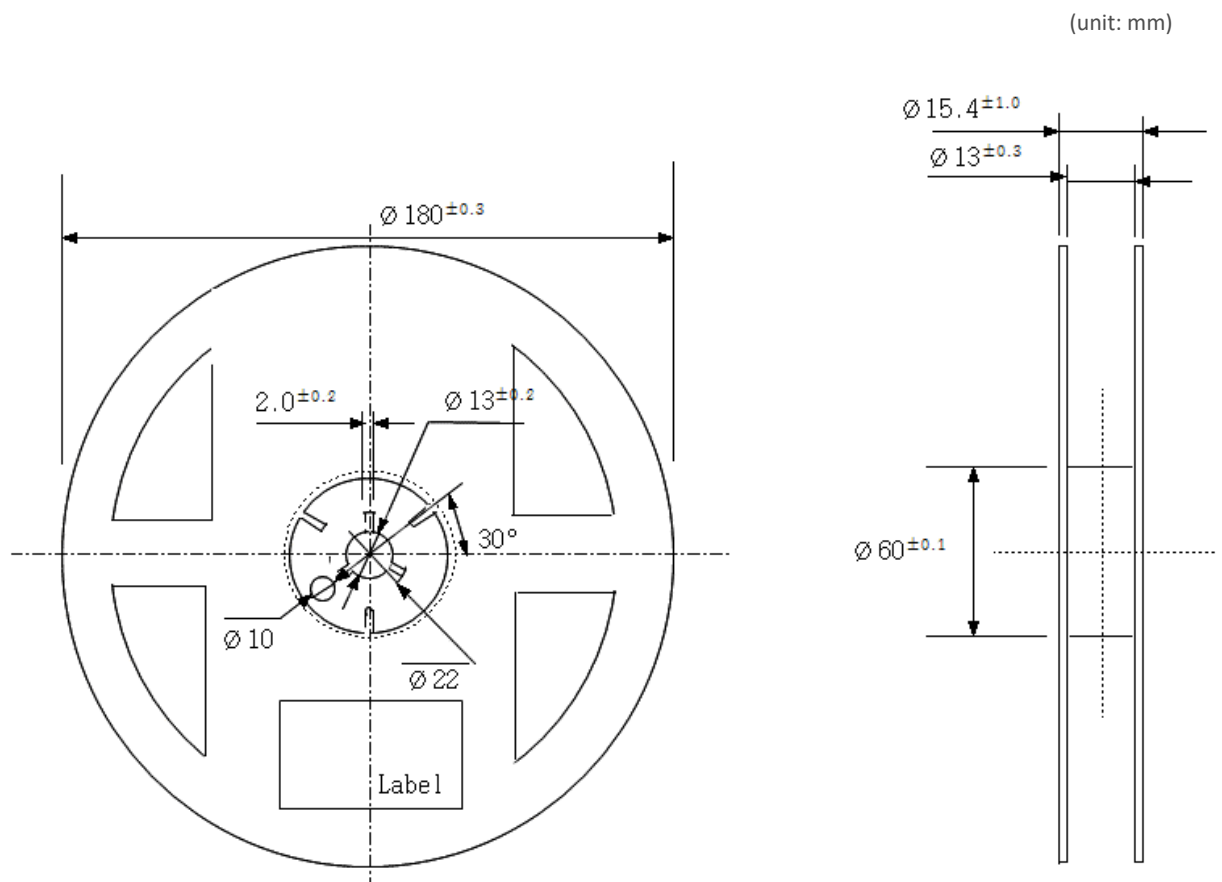

Notes:

- 1) Quantity: The quantity/reel is 800 pcs
- 2) Cumulative tolerance: Cumulative tolerance / 10 pitches is ± 0.2 mm
- 3) Adhesion strength of cover tape: Adhesion strength is 0.1-0.7 N when the cover tape is turned off from the carrier tape at 10° angle to the carrier tape
- 4) Packaging: P/N, Manufacturing data code no. and quantity are indicated on the aluminum packing bag

8. Label Structure

a) Label Structure

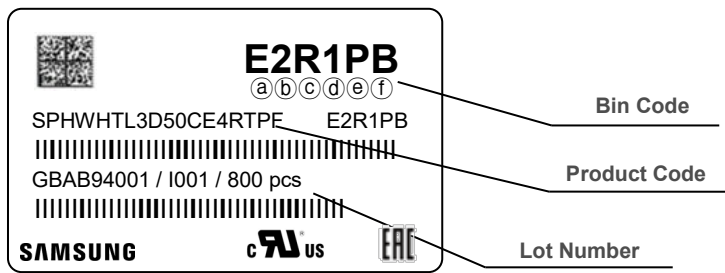

Note: Denoted bin code and product code above is only an example (see description on page 7)

Bin Code:

- ⒶⒷ: Forward Voltage bin (refer to 9 page)
- ⒸⒹ: Chromaticity bin (refer to 9 page)
- ⒺⒻ: Luminous Flux bin (refer to 7 page)

b) Lot Number

The lot number is composed of the following characters:

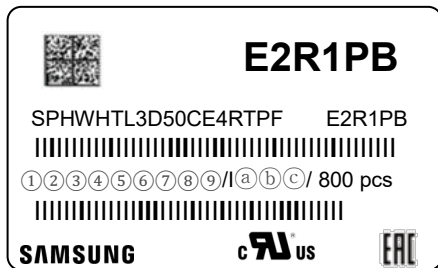

①②③④⑤⑥⑦⑧⑨ / | ⒶⒷⒸ / 800 pcs

- ①, ② : Production site (GB : Nanchang, China)
- ③ : Product state (A: Normal, B: Bulk, C: First Production, R: Reproduction, S: Sample)
- ④ : Year (Y: 2014, Z: 2015, A: 2016, B: 2017, C: 2018, D: 2019 ...)
- ⑤ : Month (1~9, A, B, C)
- ⑥ : Day (1~9, A, B~V)
- ⑦⑧⑨ : Product serial number (001 ~ 999)
- ⒶⒷⒸ : Reel number (001 ~ 999)

9. Packing Structure

a) Packing Process

Reel

E2R1PB
 SPHWHTL3D50CE4RTPF E2R1PB
 GBAB94001 / I001 / 800 pcs

SAMSUNG **UL** **US** **ERC**

Aluminum Vinyl Packing Bag

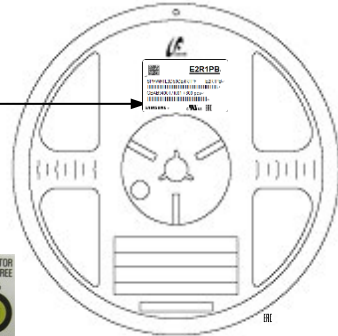
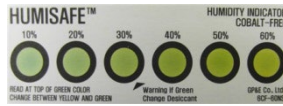

E2R1PB
 SPHWHTL3D50CE4RTPF E2R1PB
 GBAB94001 / I001 / 800 pcs

SAMSUNG **UL** **US** **ERC**



Outer Box

Material: Paper SW(B)

Type	Size (mm)			Note
	(a)	(b)	(c)	
7 inch (L)	245 ± 5	220 ± 5	182 ± 5	Up to 8 reels
7 inch (S)	245 ± 5	220 ± 5	86 ± 5	Up to 4 reels

E2R1PB
 SPHWHTL3D50CE4RTPF E2R1PB
 GBAB94001 / I000 / 6,400 pcs

SAMSUNG **UL** **US** **ERC**

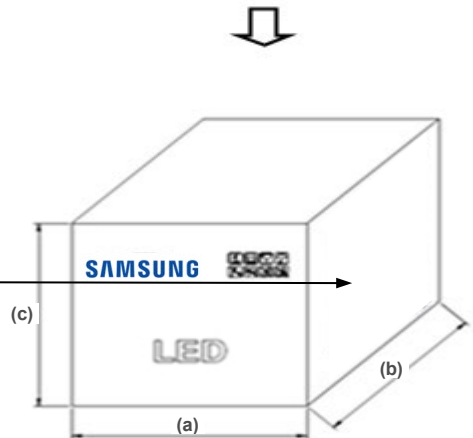

(1P) Supplier Part Number : SPHWHTL3D50CE4RTPF 	(Q) Quantity : 6,400
(33P) Bin Code / E2R1PB 	(100) Data Code : 1735
(1T) Lot Number / GBAB94001 	(4L) Country of Origin : KR

b) Aluminum Vinyl Packing Bag



CAUTION

This bag contains
MOISTURE SENSITIVE DEVICES

LEVEL
2a

1. Shelf life in sealed bag: 12 months at <math>< 40^{\circ}\text{C}</math> and <math>< 90\%</math> relative humidity (RH)
2. Peak package body temperature: 240 °C
3. After this bag is opened, devices that will be subjected to reflow solder or other high temperature processes must be:
 - a. Mounted within 672 hours at factory conditions of equal to or less than 30°C / 60% RH, or
 - b. Stored at <math>< 10\%</math> RH
4. Devices require bake, before mounting, if:
 - a. Humidity Indicator Card is > 65% when read at 23±5°C, or
 - b. 2a is not met.
5. If baking is required, devices must be baked for 1 hours at 60±5°C

Note: If device containers cannot be subjected to high temperature or shorter bake times are desired, reference IPC/JEDEC J-STD-033 for bake procedure.

Bag seal due date: _____

(If blank, see code label)

Note: Level and body temperature by IPC/JEDEC J-STD-020



E2R1PB

SPHWHTL3D50CE4RTPF E2R1PB

GBAB94001 / I001 / 800 pcs

SAMSUNG **c** **RoHS** **US** **ERC**





ATTENTION

OBserve PREcautions
FOR HANDLING
ELECTROSTATIC
SENSITIVE
DEVICES



주의 사항

이 알루미늄 지퍼 팩은 습기 및 정전기로부터 제품을 보호하기 위하여 제작되었습니다. 개봉 후에는 즉시 솔더 작업을 실시하는 것을 권장합니다.

습기 및 정전기로부터 제품을 보호 하기 위해서 개봉 후 사용하지 않는 자재는 본 팩에 넣어 보관 하시기 바랍니다. 사용하지 않는 자재를 본 팩에 넣을 때는 반드시 동봉된 드라이 팩과 함께 넣고 지퍼부분을 완전하게 밀봉하여 주시기 바랍니다.

Important

This Al Zipper bag is designed to protect the enclosed products from moisture and ESD. Once opened, the products should be soldered onto the printed circuit board immediately. When not in use, please do not leave the products unprotected by the Al Zipper Bag. To repack unused products., please ensure the zip-lock is completely sealed with the dry pack left inside.

c) Silica Gel & Humidity Indicator Card inside Aluminum Vinyl Bag



HUMISAFE™

HUMIDITY INDICATOR COBALT-FREE

10%



20%



30%



40%



50%



60%



READ AT TOP OF GREEN COLOR
CHANGE BETWEEN YELLOW AND GREEN

Warning If Green
Change Desiccant

GP&E Co., Ltd.
6CF-60NS

10. Precautions in Handling & Use

- 1) For over-current protection, users are recommended to apply resistors connected in series with the LEDs to mitigate sudden change of the forward current caused by shift of forward voltage.
- 2) This device should not be used in any type of fluid such as water, oil, organic solvent, etc. When cleaning is required, IPA is recommended as the cleaning agent. Some solvent-based cleaning agent may damage the silicone resins used in the device.
- 3) When the device is in operation, the forward current should be carefully determined considering the maximum ambient temperature and corresponding junction temperature.
- 4) LEDs must be stored in a clean environment. Shelf life of sealed bags is 12 months at temperature 0~40 °C, 0~90 % RH.
- 5) After storage bag is opened, device subjected to soldering, solder reflow, or other high temperature processes must be:
 - a. Mounted within 672 hours (28 days) at an assembly line with a condition of no more than 30 °C / 60 % RH, or
 - b. Stored at <10 % RH
- 6) Repack unused devices with anti-moisture packing, fold to close any opening and then store in a dry place.
- 7) Devices require baking before mounting, if humidity card reading is >60 % at 23 ± 5 °C.
- 8) Devices must be baked for 1 hour at 60 ± 5 °C, if baking is required.
- 9) The LEDs are sensitive to the static electricity and surge current. It is recommended to use a wrist band or anti-electrostatic glove when handling the LEDs. If voltage exceeding the absolute maximum rating is applied to LEDs, it may cause damage or even destruction to LED devices. Damaged LEDs may show some unusual characteristics such as increase in leakage current, lowered turn-on voltage, or abnormal lighting of LEDs at low current.
- 10) VOCs (Volatile Organic Compounds) can be generated from adhesives, flux, hardener or organic additives used in luminaires (fixtures). Transparent LED silicone encapsulant is permeable to those chemicals and they may lead to a discoloration of encapsulant when they exposed to heat or light. This phenomenon can cause a significant loss of light emitted (output) from the luminaires. In order to prevent these problems, we recommend users to know the physical properties of materials used in luminaires and they must be carefully selected.

Legal and additional information.

[About Samsung Electronics Co., Ltd.](#)

Samsung Electronics Co., Ltd. inspires the world and shapes the future with transformative ideas and technologies, redefining the worlds of TVs, smartphones, wearable devices, tablets, cameras, digital appliances, printers, medical equipment, network systems and semiconductors.

We are also leading in the Internet of Things space through, among others, our Digital Health and Smart Home initiatives. We employ 307,000 people across 84 countries. To discover more, please visit our official website at www.samsung.com and our official blog at global.samsungtomorrow.com.

“Samsung provides limited warranty for its LED products, the full text of which is available at <https://www.samsung.com/led/support/warranties>“

Copyright © 2017 Samsung Electronics Co., Ltd. All rights reserved.

Samsung is a registered trademark of Samsung Electronics Co., Ltd.

Specifications and designs are subject to change without notice. Non-metric weights and measurements are approximate. All data were deemed correct at time of creation. Samsung is not liable for errors or omissions. All brand, product, service names and logos are trademarks and/or registered trademarks of their respective owners and are hereby recognized and acknowledged.

Samsung Electronics Co., Ltd.

1, Samsung ro

Giheung-gu

Yongin-si, Gyeonggi-do, 17113

KOREA

www.samsungled.com

The Samsung logo, consisting of the word "SAMSUNG" in a bold, blue, sans-serif font.