

DESCRIPTION: MALE - DIP SOLDER / MACHINED - PREMIUM

DIMENSIONS(mm)							
SIZE	A ^{±.36}	B ^{±.10}	C ^{±.15}	D ^{±.15}	E ^{±.38}	F ^{±.25}	G ^{±.25}
9	30.80	24.99	17.00	8.40	19.20	12.60	10.90
15	39.15	33.32	25.30	8.40	27.70	12.60	10.90
25	53.04	47.04	39.00	8.40	41.10	12.60	10.90
37	69.32	63.50	55.40	8.40	57.30	12.60	10.90
50	66.93	61.11	52.80	11.10	55.10	15.20	13.60

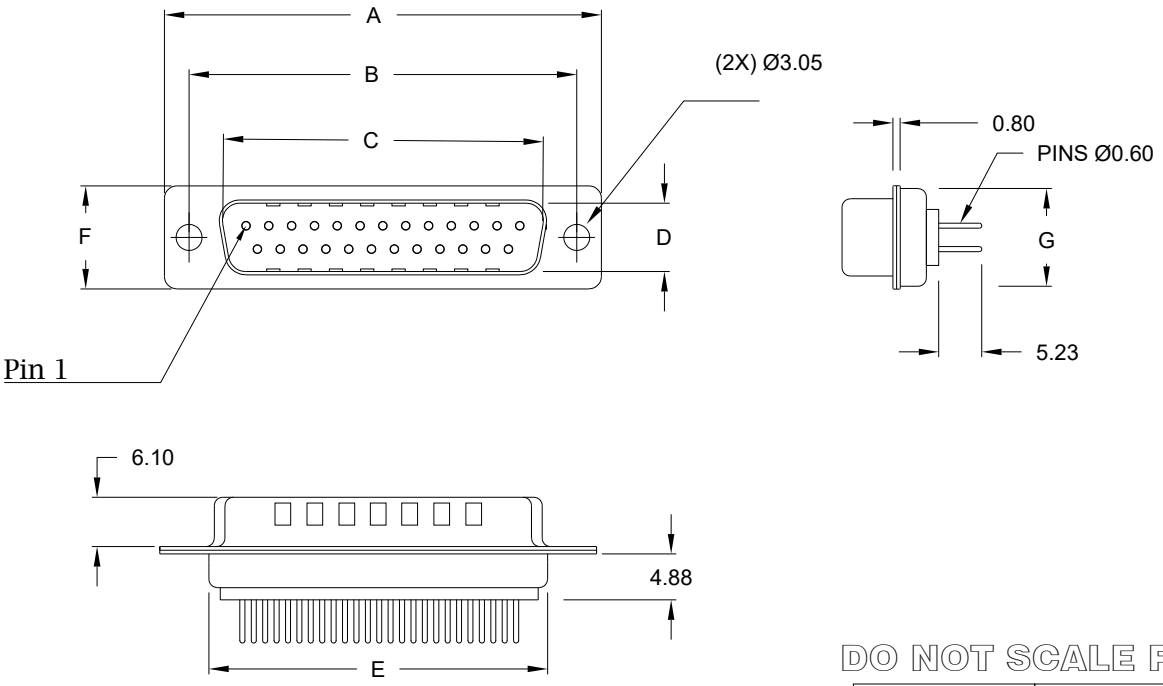

MATERIAL:

SHELL: STEEL, TIN
 INSULATOR: UL 94V-O RATED, PA6T
 PROCESS TEMP.: 260°C
 CONTACT: BRASS (FLOATING CONTACTS)

ELECTRICAL:

CURRENT RATING: 5 AMPS
 CONTACT RESISTANCE: 15 mOhms Max.
 INSULATION RESISTANCE: 1,000 MOhms Min.
 VOLTAGE: 500VAC FOR 1 MINUTE
 TEMPERATURE: -50° C TO 100° C

172-YYY-112RYY1

- SERIES _____
- POSITIONS _____
- 009 _____
- 015 _____
- 025 _____
- 037 _____
- 050 _____
- GENDER _____
- 1 = MALE
- TERMINATION _____
- 1 = DIP SOLDER
- SHELL PLATING _____
- 2 = TIN (GROUND INDENTS)
- RoHS COMPLIANT _____
- HARDWARE OPTIONS _____
- 00 = NO HARDWARE
- 01 = .065" NUT (PCB SIDE)
- 02 = .250" NUT (PCB SIDE)
- 03 = .250" NUT (MATING SIDE)
- 05 = .237" 4-40 BOARD LOCK
- 90 = .237" 4-40 BOARD LOCK FOR 0.093" BOARD MAX.
- 91 = .237" 4-40 SPACER/ BOARD LOCK
- 92 = .237" 4-40 SPACER/ BOARD LOCK FOR 0.093" BOARD MAX.
- PLATING OPTIONS _____
- 1 = GOLD FLASH
- 2 = 30MICRO-INCH GOLD

DO NOT SCALE FROM DRAWING

UNITS = mm

<p>THESE DRAWINGS AND SPECIFICATIONS ARE THE PROPERTY OF NorComp AND SHALL NOT BE REPRODUCED, COPIED OR USED AS THE BASIS FOR THE MANUFACTURE OF SALE OF APPARATUS WITHOUT WRITTEN PERMISSION.</p> <p>NorComp</p>	DRAWN: PAM JENKINS	DATE: 09-12-05	
	SCALE: NTS	SHEET OF 1 3	REV 19
	DWG NO. 172-YYY-112RYY1		

RoHS COMPLIANT

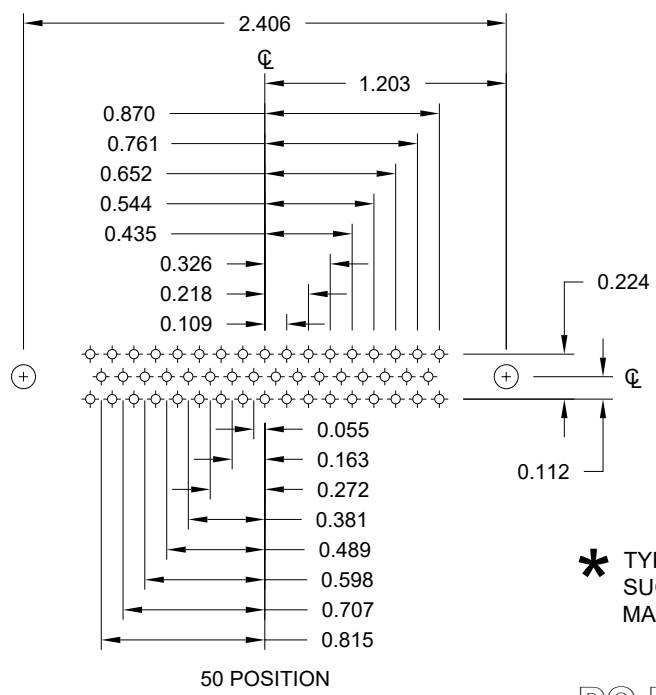
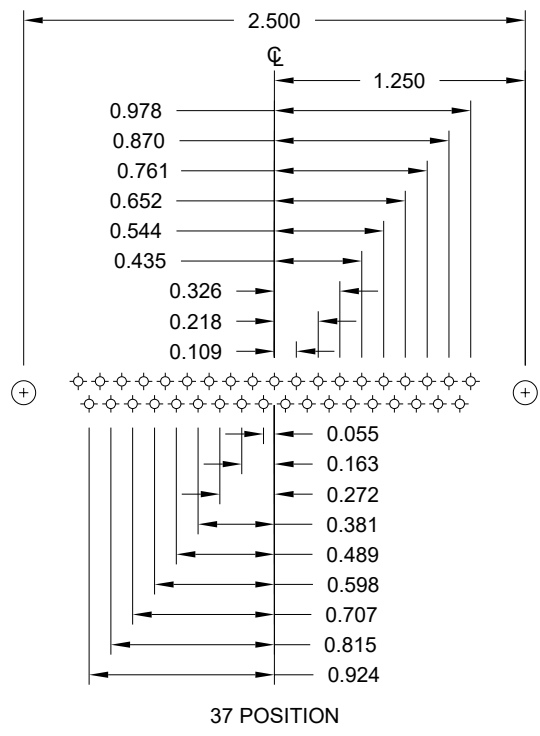
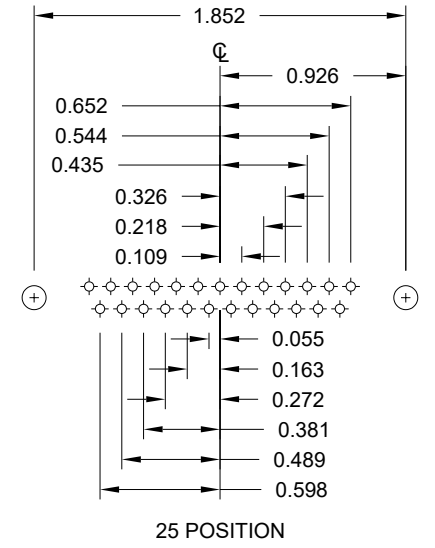
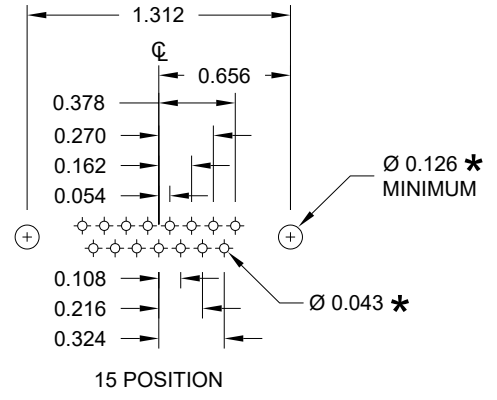
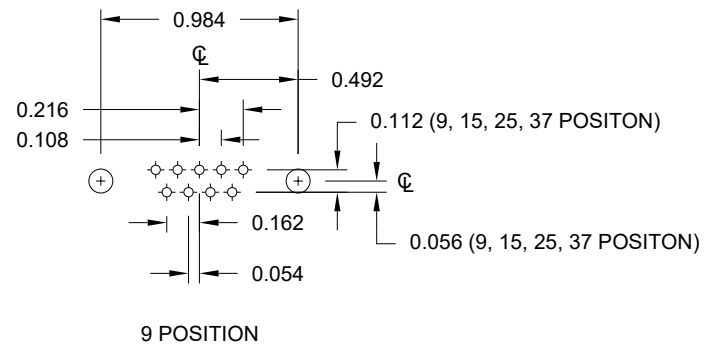

UNITS = inch

* TYP. SUGGESTED SIZE MAY NOT BE SUITABLE FOR ALL APPLICATIONS

DO NOT SCALE FROM DRAWING

	THESE DRAWINGS AND SPECIFICATIONS ARE THE PROPERTY OF NorComp AND SHALL NOT BE REPRODUCED, COPIED OR USED AS THE BASIS FOR THE MANUFACTURE OF SALE OF APPARATUS WITHOUT WRITTEN PERMISSION.		DRAWN: PAM JENKINS	DATE: 09-12-05
	<h1>NorComp</h1>		SCALE: NTS	SHEET 2 OF 3
DWG NO. 172-YYY-112RYY1				

DESCRIPTION: CLINCH NUT HARDWARE

TOLERANCE:
 ALL DIMENSIONS ARE ±0.010
 UNLESS OTHERWISE
 SPECIFIED

ALL CLINCH-NUTS ARE 4-40 INTERNAL THREADS

****NOTE: 90 & 92 OPTION FOR 0.093" MAX. BOARD THICKNESS**

"01" // PCB SIDE

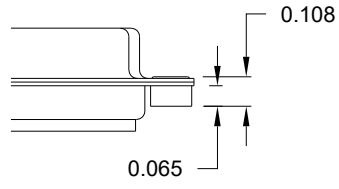

"02" // PCB SIDE

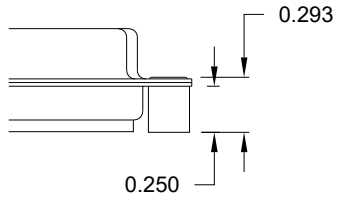

"03" // MATING SIDE

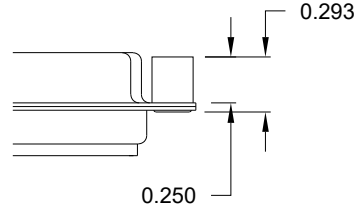

"05" // PCB SIDE

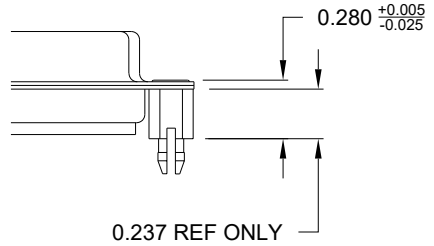

"91" // PCB SIDE

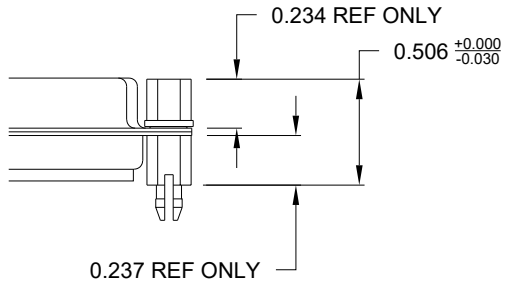

"90" // PCB SIDE **

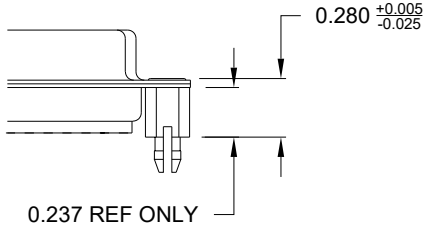

NOTE: 4-40 FEMALE SCREW LOCK IS REMOVABLE

"92" // PCB SIDE **

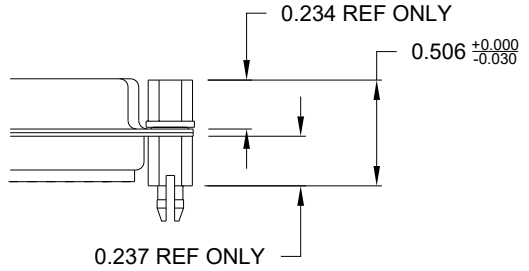

UNITS = inch

DO NOT SCALE FROM DRAWING

RoHS COMPLIANT

	THESE DRAWINGS AND SPECIFICATIONS ARE THE PROPERTY OF NorComp AND SHALL NOT BE REPRODUCED, COPIED OR USED AS THE BASIS FOR THE MANUFACTURE OF SALE OF APPARATUS WITHOUT WRITTEN PERMISSION.		DRAWN: PAM JENKINS	DATE: 09-12-05	
	NorComp		SCALE: NTS	SHEET 3 OF 3	REV 19
			DWG NO. 172-YYY-112RYY1		