

Withwave's T-Probe is coaxial probe that offers one signal pin on center and several fixed pitch ground contact with low inductance. This probe provides excellent electrical performance for applications having test point with adjacent grounds. This probe have various **pitch range of 0.8, 1.5, 2.5 mm** from signal to ground contacts and is produced by precision manufacturing process.

It is available for signal probing test in these applications such as RF module signal insertion/output measurement, high speed digital & high freq. circuit board analysis.

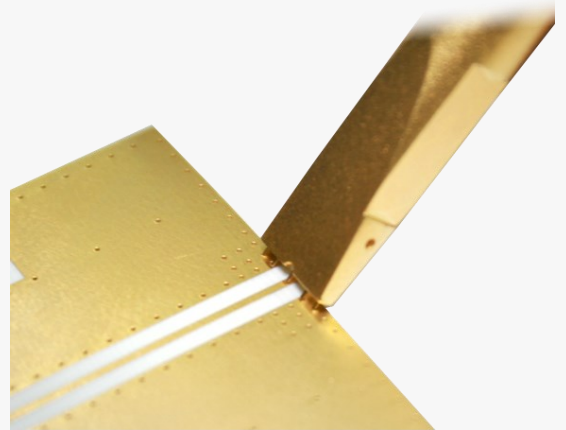

■ Features

- DC to 20 GHz (3.5 mm type) & 40 GHz bandwidth (2.92 mm type)
- Low insertion (<0.5 dB) and return loss (>10 dB)
- GSG, GS configuration (0.8/1.5/2.5 mm pitch range)

■ Advantage

- Easy for signal probing test without any soldering process on circuit board
- Compliant pogo pins allows probing of non-planar structures, walls of module & other obstructions
- Robust pins with repeatability provide longer probing life time and reduce pin damage

■ Applications

- RF & Microwave module signal insertion, detection & output measurement
- High frequency circuit board electrical performance analysis
- High speed digital circuit analysis
- Signal integrity probing & Device characterization

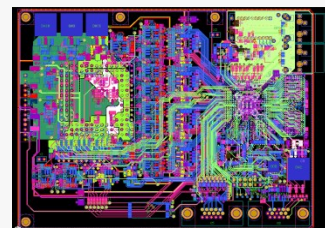
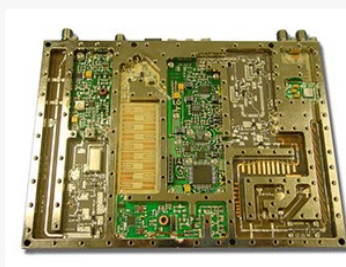

■ **Specification**

Scope	Items	Specification
Electrical	Freq. range	DC to 20 GHz (3.5 mm Connector) DC to 40 GHz (2.92 mm Connector)
	Insertion loss	< 0.5 dB
	Return loss	> 10 dB
Mechanical	Connector type	3.5 mm(F) / 2.92 mm(F)
	Probe pitch	0.8/1.5/2.5 mm (from signal to ground)
	Pin type	Pogo Structure

* RoHS Compliant

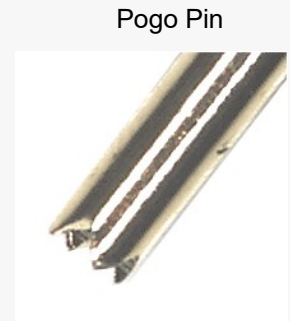
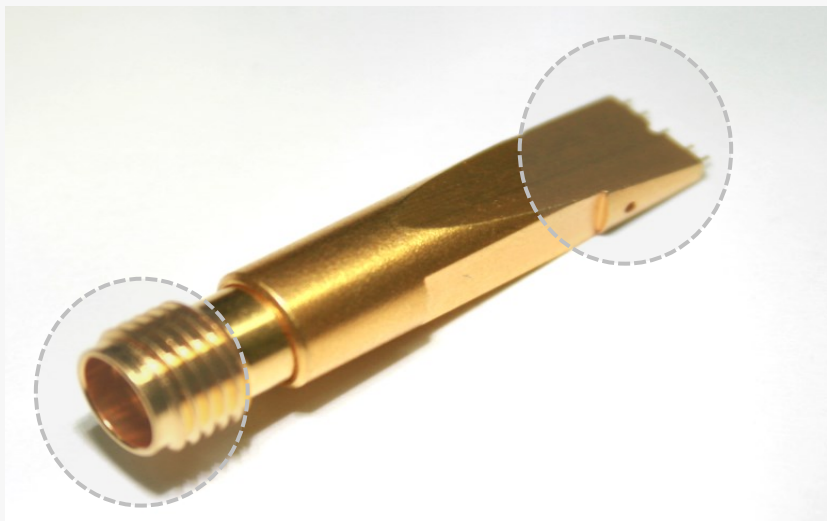

Crown type



Interface : 3.5 mm type (DC to 20 GHz)
2.92 mm type (DC to 40 GHz)

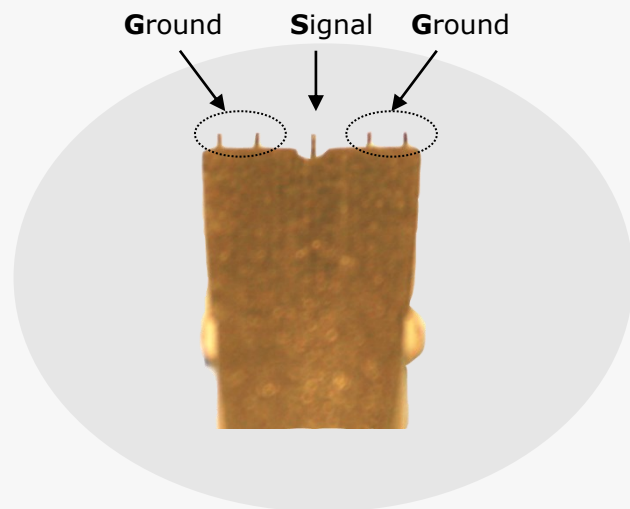



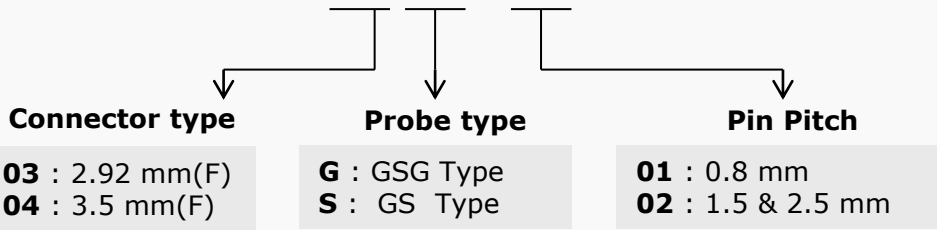

■ **Ordering Information**

PU-03G-01

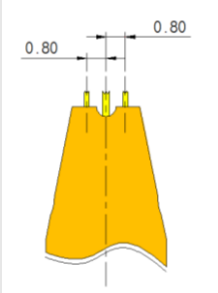

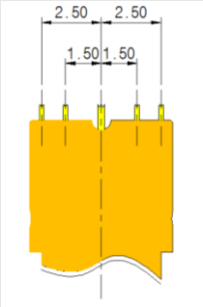
▪ **GSG Type (pitch : 0.8/ 1.5, 2.5)**

Part No.	PU-03G-01 PU-04G-01	PU-03G-02 PU-04G-02
Pitch (mm)	0.8	1.5 & 2.5
Structure	 	 

■ **Ordering Information**

PU-03G-01

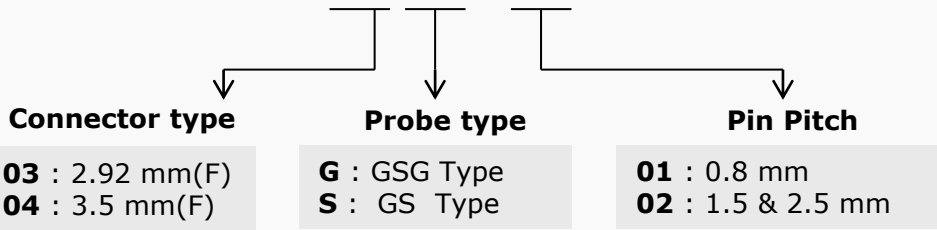

▪ **GS Type (pitch : 0.8/ 1.5, 2.5)**

Part No.	PU-03S-01 PU-04S-01	PU-03S-02 PU-04S-02
Pitch (mm)	0.8	1.5 & 2.5
Structure		

■ **Accessories : Test Cable Assembly**

W203 cable assembly

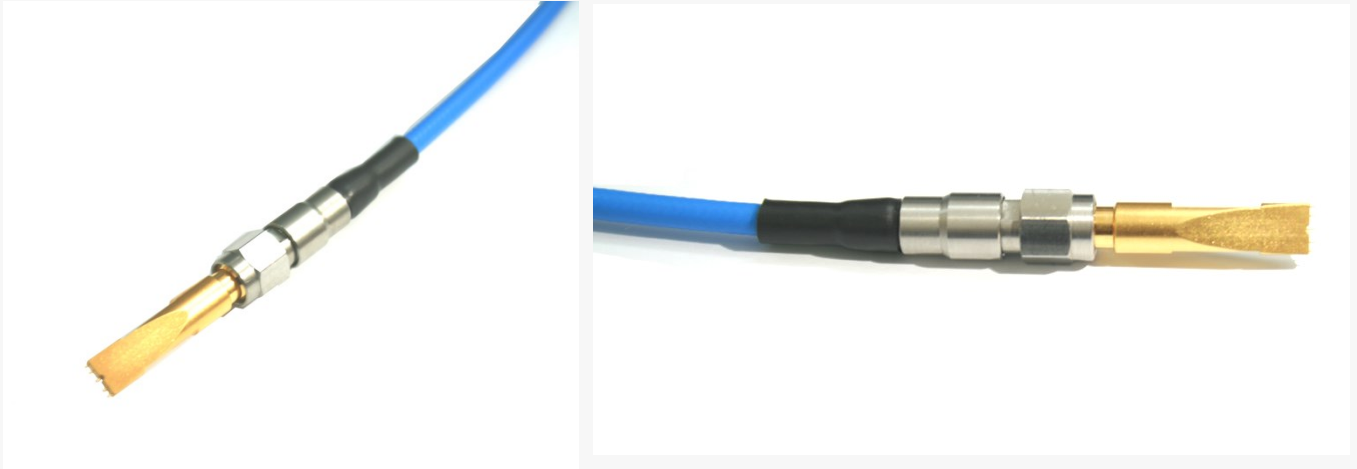

▪ **Part No. : W203-SM1SM1-1M**

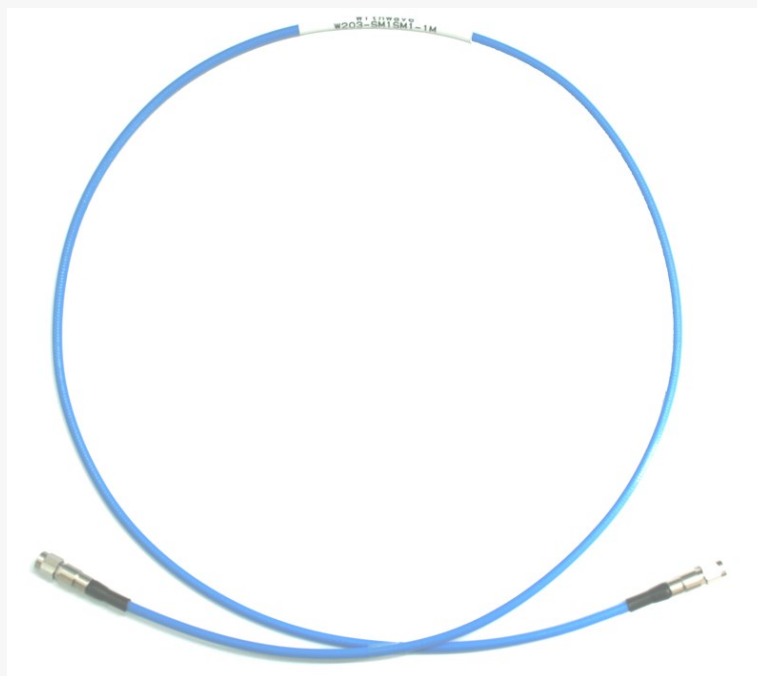

- Frequency : DC to 26.5 GHz
- Connector : SMA(Male)
- Cable :W203
- Cable Diameter : 3.80 mm

■ **Accessories : Test Cable Assembly**

W100 cable assembly

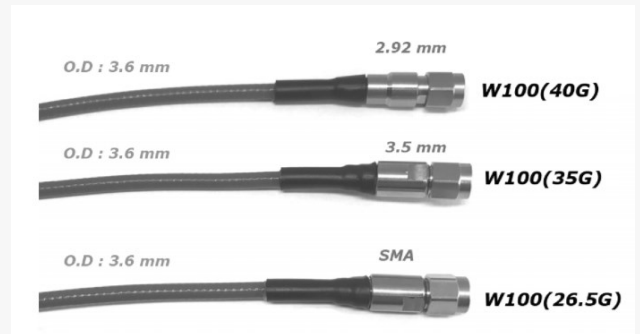

- Frequency : DC to 40 GHz
- Connector : 2.92 mm (Male)
- Cable :W100
- Cable Diameter : 3.60 mm

■ Test results

GSG Type (pitch : 0.8 mm)

Part No : PU-04G-01



- Substrate : RO4350B (10 mil)
- Microstrip type

Freq. range: 10 MHz~ 20 GHz

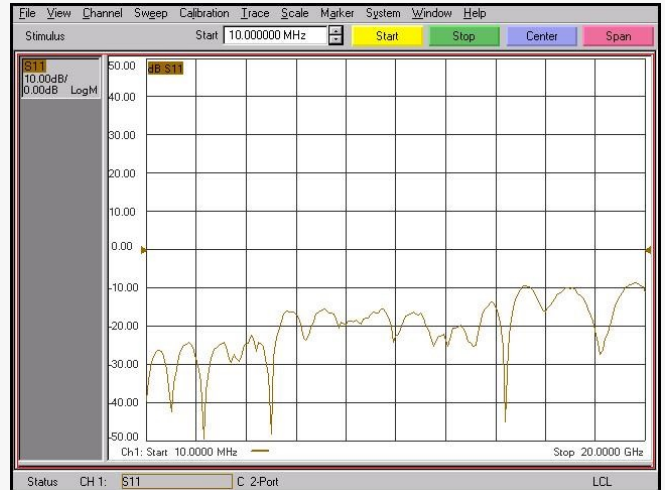

GSG Type (pitch : 1.5 mm & 2.5 mm)

Part No : PU-04G-02



- Substrate : RO4350B (10 mil)
- Microstrip type

Freq. range: 10 MHz~ 20 GHz

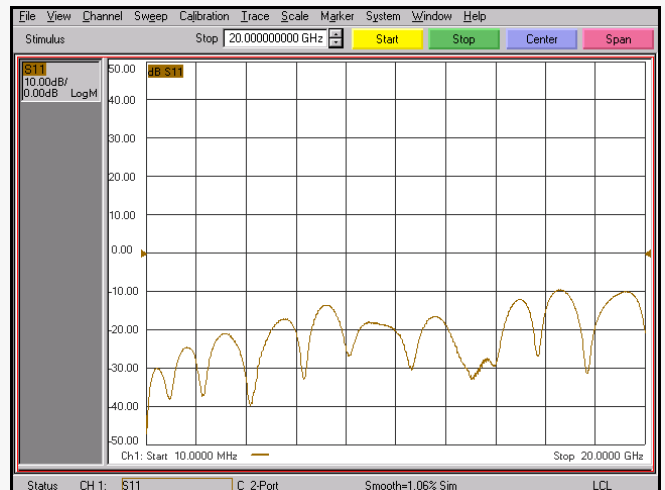

■ Test results

GS Type (pitch : 0.8 mm)

Part No : PU-04S-01

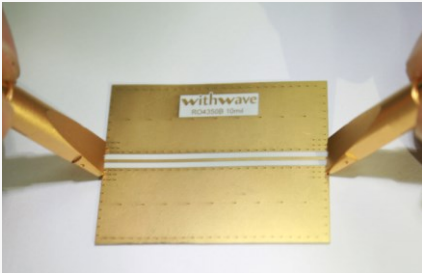

- Substrate : RO4350B (10 mil)
- Microstrip type

Freq. range: 10 MHz~ 20 GHz



GS Type (pitch : 1.5 & 2.5 mm)

Part No : PU-04S-02



- Substrate : RO4350B (10 mil)
- Microstrip type

Freq. range: 10 MHz~ 20 GHz

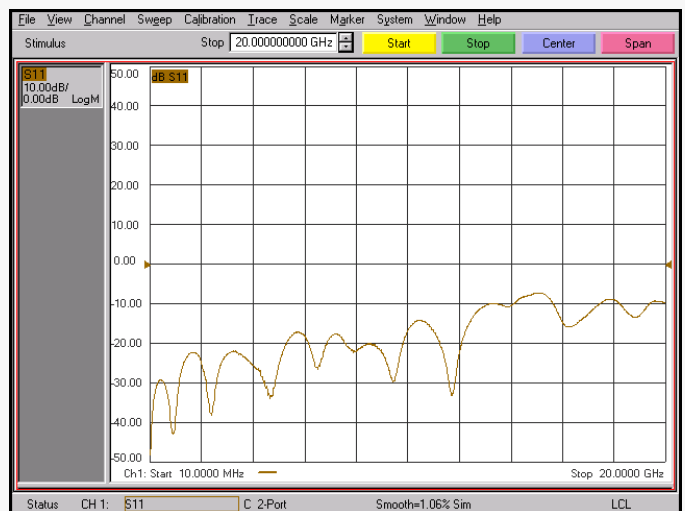

■ **Test results**

GSG Type (pitch : 0.8 mm)

Part No : PU-03G-01

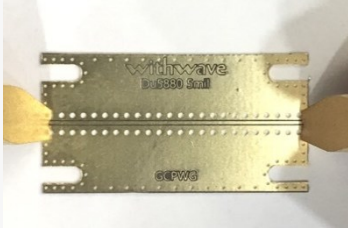

- Substrate : Duroid 5880 (5 mil)
- GCPWG type

Freq. range: 10 MHz~ 40 GHz



GSG Type (pitch : 0.8 mm)

Part No : PU-03G-01



- Substrate : Duroid 5880 (5 mil)
- Top Ground Microstrip

Freq. range: 10 MHz~ 40 GHz



■ Test results

GSG Type (pitch : 0.8 mm)

Part No : PU-03G-01

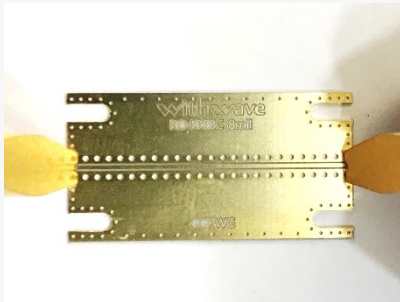

- Substrate : RO4350B (10 mil)
- GCPWG type

Freq. range: 10 MHz~ 40 GHz



■ **Test results**

GSG Type (pitch : 1.5 mm & 2.5 mm)

Part No : PU-03G-02

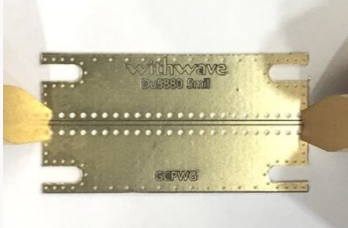

- **Substrate : Duroid 5880 (5 mil)**
- **GCPWG type**

Freq. range: 10 MHz~ 40 GHz

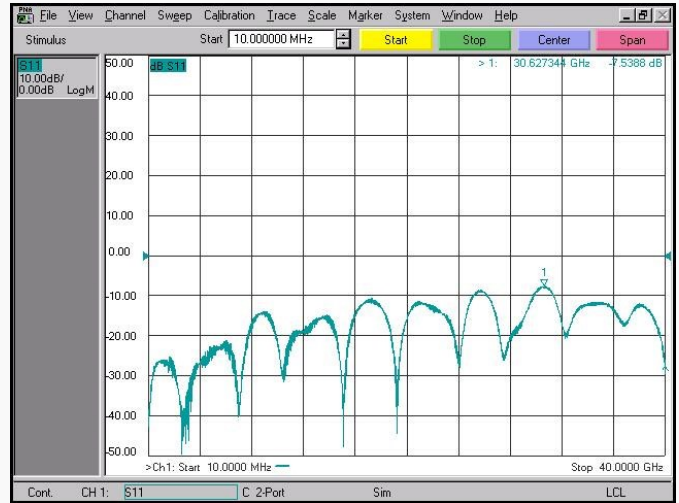

Freq. range: 10 MHz~ 40 GHz

GSG Type (pitch : 1.5 mm & 2.5 mm)

Part No : PU-03G-02



- **Substrate : Duroid 5880 (5 mil)**
- **Top Ground Microstrip**



Drawing

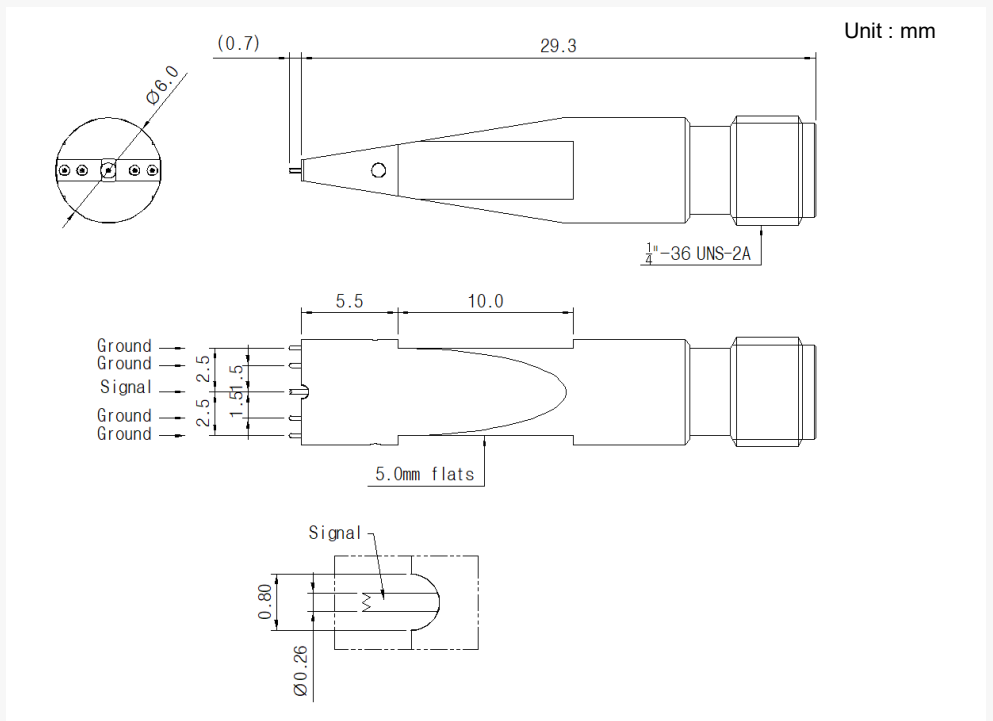
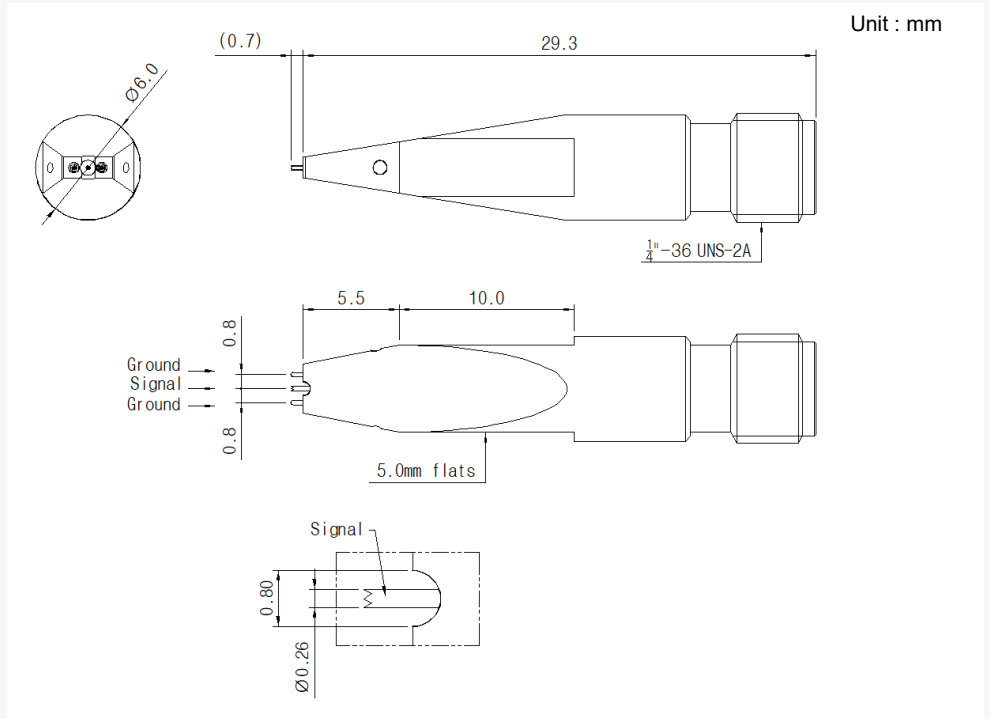

Drawing

**Part No : PU-03S-01
PU-04S-01**

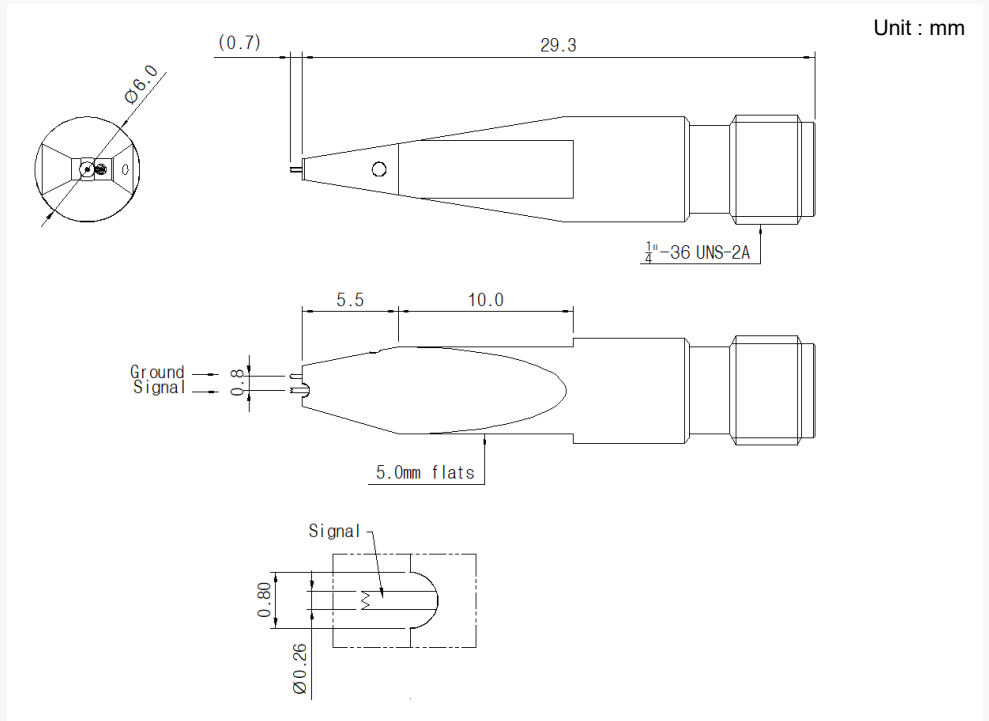

**Part No : PU-03S-02
PU-04S-02**

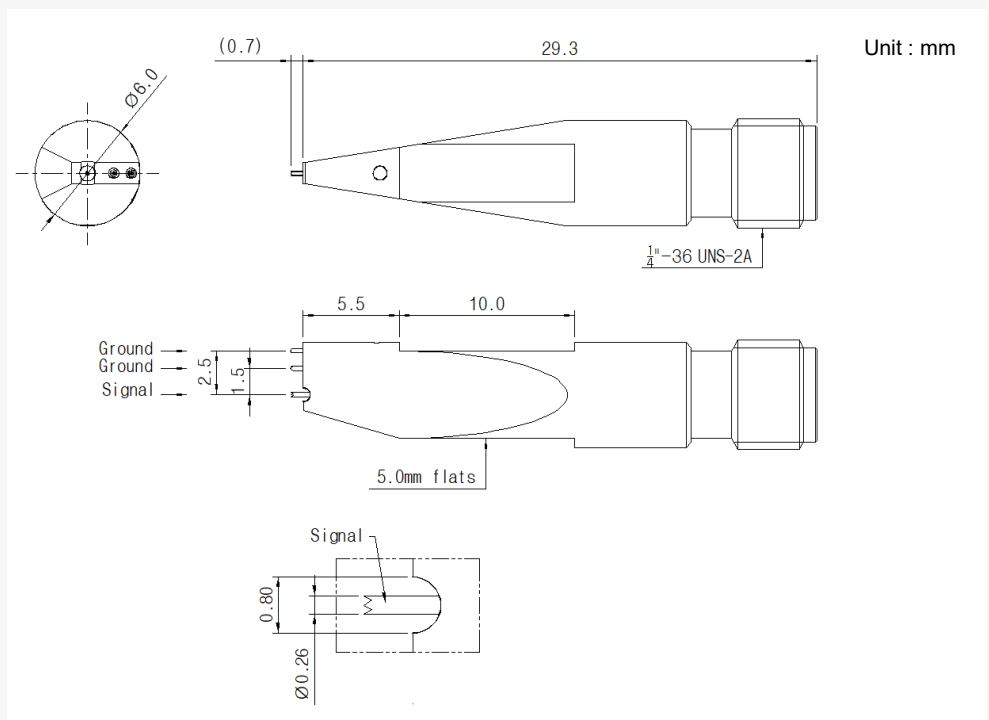

■ **Revision History**

Revision	Date	Changes
Ver 1.0	2015-10-01	Released T-probe(20 GHz)
Ver.2.0	2018-06-20	Add new T-probe for 40 GHz
Ver 2.1	2019-06-20	Updated drawing of T-probe
Ver 2.2	2019-11-15	Updated specification
Ver 2.3	2021-05-17	Update photo