

XLamp® XHP70.3 LEDs

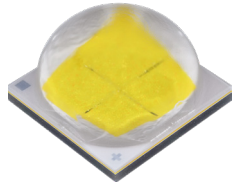

XHP70.3 High Density

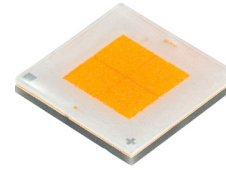

XHP70.3 High Intensity

PRODUCT DESCRIPTION

The XLamp® XHP70.3 LEDs are the third generation of Extreme High Power LEDs that deliver the best lumen density, reliability and optical control available in their size. By leveraging the XHP family advantages, lighting manufacturers can significantly reduce their system cost by using fewer optics, PCBs and heat sinks than possible with standard LEDs.

The third generation XHP family LEDs deliver improved optical performance versus the previous generations, with higher intensity through optics than the second generation and the XHP family's highest on-axis intensity.

XLamp XHP70.3 LEDs are optimized for outdoor and premium indoor lighting applications that require large amounts of light output from small luminaires, such as stadium, outdoor area and architectural spotlight.

FEATURES

- Available in white, configurable to 6 V or 12 V by PCB layout
- Available in 5-step EasyWhite® bins at 3000 K to 5000 K CCT, 3-step EasyWhite bins at 2700 K to 5000 K and 2-step EasyWhite bins at 2700 K to 4000 K CCT
- Available in ANSI white bins at 3000 K to 7000 K CCT
- Broadcast color option at 5700 K provides maximum performance for TV events that require extremely high TLCI
- Available in standard, 70-, 80-, 90-, and 95-minimum CRI options
- Binned at 85 °C
- Maximum drive current: 7200 mA (6 V), 3600 mA (12 V)
- Low thermal resistance: 0.2 °C/W
- Wide viewing angle: 120° (HD), 115 (HI)
- Unlimited floor life at ≤ 30 °C/85% RH
- Reflow solderable - JEDEC J-STD-020C
- RoHS and REACH compliant
- UL® recognized component (E349212)



Cree LED / 4001 E. Hwy. 54, Suite 2000 / Durham, NC 27709 USA / +1.919.313.5330 / www.cree-led.com

TABLE OF CONTENTS

Characteristics 3

Flux Characteristics, High Density EasyWhite® Order Codes and Bins 4

Flux Characteristics, High Density ANSI White Order Codes and Bins..... 7

Flux Characteristics, High Density Broadcast Order Codes and Bins..... 10

Flux Characteristics, High Intensity EasyWhite® Order Codes and Bins..... 11

Flux Characteristics, High Intensity ANSI White Order Codes and Bins..... 14

Flux Characteristics, High Intensity Broadcast Order Codes and Bins..... 16

Relative Spectral Power Distribution 17

Relative Flux vs. Junction Temperature..... 17

Electrical Characteristics (T_J = 85 °C) 18

Relative Flux vs. Current (T_J = 85 °C)..... 19

Relative Chromaticity vs Current (Warm White) 20

Relative Chromaticity vs Temperature (Warm White)..... 21

Typical Spatial Distribution..... 21

Thermal Design 22

Performance Groups - Luminous Flux (T_J = 85 °C) 23

Performance Groups - Chromaticity 23

EasyWhite® Chromaticity Regions Plotted on the 1931 CIE Curve..... 27

ANSI Standard Cool White Kits Plotted on ANSI Standard Chromaticity Regions 28

Standard Warm and Neutral White Kits Plotted on ANSI Standard Chromaticity Regions 29

Bin and Order-Code Format..... 30

Reflow Soldering Characteristics..... 31

Notes 32

Mechanical Dimensions 34

Electrical Configuration 36

Tape and Reel..... 37

Packaging..... 39

CHARACTERISTICS

XHP70.3 LEDs are tested and binned in the 12-V configuration. See the Mechanical Dimensions section on page 34 for pad layout options.

Characteristics	Unit	Minimum	Typical	Maximum
Thermal resistance, junction to solder point ^o	°C/W		0.2	
Viewing angle (FWHM) - High Density	degrees		120	
Viewing angle (FWHM) - High Intensity	degrees		115	
Temperature coefficient of voltage (6 V)*	mV/°C		-2.5	
Temperature coefficient of voltage (12 V)	mV/°C		-5.0	
ESD withstand voltage (HBM per Mil-Std-883D)	V			8000
DC forward current (6 V)*	mA			7200
DC forward current (12 V)	mA			3600
Reverse voltage	V			1
Forward voltage (6 V, @ 2100 mA, 85 °C)*	V		5.6	6.1
Forward voltage (12 V, @ 1050 mA, 85 °C)	V		11.2	12.2
LED junction temperature	°C			150

Note:

- ◊ Thermal resistance measurement was performed per the JEDEC JESD51-14 standard. See the [Thermal Resistance Measurement application note](#) for more details.
- * Data for the 6-V configuration is calculated and for reference only.

FLUX CHARACTERISTICS, HIGH DENSITY EASYWHITE® ORDER CODES AND BINS

The following table provides order codes for XLamp XHP70.3 High Density LEDs. For a complete description of how the flux and chromaticity groups are reflected in the bin code and order code nomenclature, please see the Bin and Order Code Formats section (page 30).

Binning condition: $T_j = 85\text{ °C}$; 12 V, $I_f = 1050\text{ mA}$
 Reference condition: $T_j = 85\text{ °C}$; 6 V, $I_f = 2100\text{ mA}$

Nominal CCT	CRI		Minimum Luminous Flux			2-Step		3-Step		5-Step	
	Min	Typ	Group	Flux (lm) @ 85 °C	Flux (lm) @ 25 °C*	Group	Order Code	Group	Order Code	Group	Order Code
5000 K	70		P4	1965	2164					50E	XHP70D-00-0000-0D0BP450E
			P2	1830	2015				XHP70D-00-0000-0D0BP250E		
			N4	1710	1883				XHP70D-00-0000-0D0BN450E		
	80		P2	1830	2015			50G	XHP70D-00-0000-0D0HP250G		
			N4	1710	1883				XHP70D-00-0000-0D0HN450G		
			N2	1590	1751				XHP70D-00-0000-0D0HN250G		
			M4	1485	1635				XHP70D-00-0000-0D0HM450G		
	90		N2	1590	1751			50G	XHP70D-00-0000-0D0UN250G		
			M4	1485	1635				XHP70D-00-0000-0D0UM450G		
			M2	1380	1520				XHP70D-00-0000-0D0UM250G		

- Notes
- Cree LED maintains a tolerance of ±7% on flux and power measurements, ±0.005 on chromaticity (CCx, CCy) measurements and a tolerance of ±2 on CRI measurements. See the Measurements section (page 32).
 - XLamp XHP70.3 LED order codes specify only a minimum flux bin and not a maximum. Cree LED may ship reels in flux bins higher than the minimum specified by the order code without advance notice. Shipments will always adhere to the chromaticity bin restrictions specified by the order code.
 - Flux values @ 25 °C are calculated and for reference only.

FLUX CHARACTERISTICS, HIGH DENSITY EASYWHITE® ORDER CODES AND BINS - CONTINUED

Nominal CCT	CRI		Minimum Luminous Flux			2-Step		3-Step		5-Step	
	Min	Typ	Group	Flux (lm) @ 85 °C	Flux (lm) @ 25 °C*	Group	Order Code	Group	Order Code	Group	Order Code
4500 K	70		P4	1965	2164					45E	XHP70D-00-0000-0D0BP445E
			P2	1830	2015		XHP70D-00-0000-0D0BP245E				
			N4	1710	1883		XHP70D-00-0000-0D0BN445E				
	80		N4	1710	1883			45G	XHP70D-00-0000-0D0HN445G		
			N2	1590	1751		XHP70D-00-0000-0D0HN245G				
			M4	1485	1635		XHP70D-00-0000-0D0HM445G				
	90		M4	1485	1635			45G	XHP70D-00-0000-0D0UM445G		
			M2	1380	1520		XHP70D-00-0000-0D0UM245G				
			K4	1290	1420		XHP70D-00-0000-0D0UK445G				
4000 K	70		P4	1965	2164					40E	XHP70D-00-0000-0D0BP440E
			P2	1830	2015		XHP70D-00-0000-0D0BP240E				
			N4	1710	1883		XHP70D-00-0000-0D0BN440E				
	80		N4	1710	1883	40H	XHP70D-00-0000-0D0HN440H	40G	XHP70D-00-0000-0D0HN440G		
			N2	1590	1751		XHP70D-00-0000-0D0HN240H		XHP70D-00-0000-0D0HN240G		
			M4	1485	1635		XHP70D-00-0000-0D0HM440H		XHP70D-00-0000-0D0HM440G		
	90		M4	1485	1635	40H	XHP70D-00-0000-0D0UM440H	40G	XHP70D-00-0000-0D0UM440G		
			M2	1380	1520		XHP70D-00-0000-0D0UM240H		XHP70D-00-0000-0D0UM240G		
			K4	1290	1420		XHP70D-00-0000-0D0UK440H		XHP70D-00-0000-0D0UK440G		

- Notes
- Cree LED maintains a tolerance of ±7% on flux and power measurements, ±0.005 on chromaticity (CCx, CCy) measurements and a tolerance of ±2 on CRI measurements. See the Measurements section (page 32).
 - XLamp XHP70.3 LED order codes specify only a minimum flux bin and not a maximum. Cree LED may ship reels in flux bins higher than the minimum specified by the order code without advance notice. Shipments will always adhere to the chromaticity bin restrictions specified by the order code.
 - Flux values @ 25 °C are calculated and for reference only.

FLUX CHARACTERISTICS, HIGH DENSITY EASYWHITE® ORDER CODES AND BINS - CONTINUED

Nominal CCT	CRI		Minimum Luminous Flux			2-Step		3-Step		5-Step	
	Min	Typ	Group	Flux (lm) @ 85 °C	Flux (lm) @ 25 °C*	Group	Order Code	Group	Order Code	Group	Order Code
3500 K	70		P2	1830	2015					35E	XHP70D-00-0000-0D0BP235E
			N4	1710	1883						XHP70D-00-0000-0D0BN435E
			N2	1590	1751						XHP70D-00-0000-0D0BN235E
	80		N4	1710	1883	35H	XHP70D-00-0000-0D0HN435H	35G	XHP70D-00-0000-0D0HN435G		
			N2	1590	1751		XHP70D-00-0000-0D0HN235H		XHP70D-00-0000-0D0HN235G		
			M4	1485	1635		XHP70D-00-0000-0D0HM435H		XHP70D-00-0000-0D0HM435G		
	90		M4	1485	1635	35H	XHP70D-00-0000-0D0UM435H	35G	XHP70D-00-0000-0D0UM435G		
			M2	1380	1520		XHP70D-00-0000-0D0UM235H		XHP70D-00-0000-0D0UM235G		
			K4	1290	1420		XHP70D-00-0000-0D0UK435H		XHP70D-00-0000-0D0UK435G		
3000 K	70		P2	1830	2015					30E	XHP70D-00-0000-0D0BP230E
			N4	1710	1883						XHP70D-00-0000-0D0BN430E
			N2	1590	1751						XHP70D-00-0000-0D0BN230E
	80		N2	1590	1751	30H	XHP70D-00-0000-0D0HN230H	30G	XHP70D-00-0000-0D0HN230G		
			M4	1485	1635		XHP70D-00-0000-0D0HM430H		XHP70D-00-0000-0D0HM430G		
	90		M2	1380	1520	30H	XHP70D-00-0000-0D0UM230H	30G	XHP70D-00-0000-0D0UM230G		
			K4	1290	1420		XHP70D-00-0000-0D0UK430H		XHP70D-00-0000-0D0UK430G		
			K2	1200	1321		XHP70D-00-0000-0D0UK230H		XHP70D-00-0000-0D0UK230G		
	2700 K	80		M4	1485	1635	27H	XHP70D-00-0000-0D0HM427H	27G	XHP70D-00-0000-0D0HM427G	
M2				1380	1520	XHP70D-00-0000-0D0HM227H		XHP70D-00-0000-0D0HM227G			
90			K4	1290	1420	27H	XHP70D-00-0000-0D0UK427H	27G	XHP70D-00-0000-0D0UK427G		
			K2	1200	1321		XHP70D-00-0000-0D0UK227H		XHP70D-00-0000-0D0UK227G		
			J4	1120	1233		XHP70D-00-0000-0D0UJ427H		XHP70D-00-0000-0D0UJ427G		

- Notes
- Cree LED maintains a tolerance of ±7% on flux and power measurements, ±0.005 on chromaticity (CCx, CCy) measurements and a tolerance of ±2 on CRI measurements. See the Measurements section (page 32).
 - XLamp XHP70.3 LED order codes specify only a minimum flux bin and not a maximum. Cree LED may ship reels in flux bins higher than the minimum specified by the order code without advance notice. Shipments will always adhere to the chromaticity bin restrictions specified by the order code.
 - Flux values @ 25 °C are calculated and for reference only.

FLUX CHARACTERISTICS, HIGH DENSITY ANSI WHITE ORDER CODES AND BINS

The following table provides order codes for XLamp XHP70.3 High Density LEDs. For a complete description of how the flux and chromaticity groups are reflected in the bin code and order code nomenclature, please see the Bin and Order Code Formats section (page 30).

Binning condition: $T_j = 85\text{ °C}$; 12 V, $I_f = 1050\text{ mA}$

Reference condition: $T_j = 85\text{ °C}$; 6 V, $I_f = 2100\text{ mA}$

Nominal CCT	Chromaticity Regions	CRI		Minimum Luminous Flux			Order Code
		Min	Typ	Group	Flux (lm) @ 85 °C	Flux (lm) @ 25 °C*	
7000 K	0A, 0B, 0C, 0D, 0R, 0S, 0T, 0U, 1A, 1B, 1C, 1D, 1R, 1S, 1T, 1U	0	68	P2	1830	2015	XHP70D-00-0000-0D00P20DT
				N4	1710	1883	XHP70D-00-0000-0D00N40DT
				N2	1590	1751	XHP70D-00-0000-0D00N20DT
		70		P2	1830	2015	XHP70D-00-0000-0D0BP20DT
				N4	1710	1883	XHP70D-00-0000-0D0BN40DT
				N2	1590	1751	XHP70D-00-0000-0D0BN20DT
		80		N2	1590	1751	XHP70D-00-0000-0D0HN20DT
				M4	1485	1635	XHP70D-00-0000-0D0HM40DT
		6500 K	1A, 1B, 1C, 1D	0	68	P2	1830
N4	1710					1883	XHP70D-00-0000-0D00N40E1
N2	1590					1751	XHP70D-00-0000-0D00N20E1
70				P2	1830	2015	XHP70D-00-0000-0D0BP20E1
				N4	1710	1883	XHP70D-00-0000-0D0BN40E1
				N2	1590	1751	XHP70D-00-0000-0D0BN20E1
80				N2	1590	1751	XHP70D-00-0000-0D0HN20E1
				M4	1485	1635	XHP70D-00-0000-0D0HM40E1
6000 K	1A, 1B, 1C, 1D, 1R, 1S, 1T, 1U, 2A, 2B, 2C, 2D, 2R, 2S, 2T, 2U			0	68	P2	1830
		N4	1710			1883	XHP70D-00-0000-0D00N40DV
		70		P2	1830	2015	XHP70D-00-0000-0D0BP20DV
				N4	1710	1883	XHP70D-00-0000-0D0BN40DV
		80		N2	1590	1751	XHP70D-00-0000-0D0HN20DV
				M4	1485	1635	XHP70D-00-0000-0D0HM40DV
		90		M4	1485	1635	XHP70D-00-0000-0D0UM40DV
				M2	1380	1520	XHP70D-00-0000-0D0UM20DV

- Notes
- Cree LED maintains a tolerance of ±7% on flux and power measurements, ±0.005 on chromaticity (CCx, CCy) measurements and a tolerance of ±2 on CRI measurements. See the Measurements section (page 32).
 - XLamp XHP70.3 LED order codes specify only a minimum flux bin and not a maximum. Cree LED may ship reels in flux bins higher than the minimum specified by the order code without advance notice. Shipments will always adhere to the chromaticity bin restrictions specified by the order code.
 - Flux values @ 25 °C are calculated and for reference only.

FLUX CHARACTERISTICS, HIGH DENSITY ANSI WHITE ORDER CODES AND BINS - CONTINUED

Nominal CCT	Chromaticity Regions	CRI		Minimum Luminous Flux			Order Code		
		Min	Typ	Group	Flux (lm) @ 85 °C	Flux (lm) @ 25 °C*			
5700 K	2A, 2B, 2C, 2D	0	68	P4	1965	2164	XHP70D-00-0000-0D00P40E2		
				P2	1830	2015	XHP70D-00-0000-0D00P20E2		
				N4	1710	1883	XHP70D-00-0000-0D00N40E2		
		70				P4	1965	2164	XHP70D-00-0000-0D0BP40E2
						P2	1830	2015	XHP70D-00-0000-0D0BP20E2
						N4	1710	1883	XHP70D-00-0000-0D0BN40E2
		80				N4	1710	1883	XHP70D-00-0000-0D0HN40E2
						N2	1590	1751	XHP70D-00-0000-0D0HN20E2
						M4	1485	1635	XHP70D-00-0000-0D0HM40E2
		90				N2	1590	1751	XHP70D-00-0000-0D0UN20E2
						M4	1485	1635	XHP70D-00-0000-0D0UM40E2
						M2	1380	1520	XHP70D-00-0000-0D0UM20E2
5000 K	3A, 3B, 3C, 3D	0	68	P4	1965	2164	XHP70D-00-0000-0D00P40E3		
				P2	1830	2015	XHP70D-00-0000-0D00P20E3		
				N4	1710	1883	XHP70D-00-0000-0D00N40E3		
		70				P4	1965	2164	XHP70D-00-0000-0D0BP40E3
						P2	1830	2015	XHP70D-00-0000-0D0BP20E3
						N4	1710	1883	XHP70D-00-0000-0D0BN40E3
		80				P2	1830	2015	XHP70D-00-0000-0D0HP20E3
						N4	1710	1883	XHP70D-00-0000-0D0HN40E3
						N2	1590	1751	XHP70D-00-0000-0D0HN20E3
		90				M4	1485	1635	XHP70D-00-0000-0D0HM40E3
						N2	1590	1751	XHP70D-00-0000-0D0UN20E3
						M4	1485	1635	XHP70D-00-0000-0D0UM40E3
				M2	1380	1520	XHP70D-00-0000-0D0UM20E3		
4500 K	4A, 4B, 4C, 4D	0	68	P4	1965	2164	XHP70D-00-0000-0D00P40E4		
				P2	1830	2015	XHP70D-00-0000-0D00P20E4		
				N4	1710	1883	XHP70D-00-0000-0D00N40E4		
		70				P4	1965	2164	XHP70D-00-0000-0D0BP40E4
						P2	1830	2015	XHP70D-00-0000-0D0BP20E4
						N4	1710	1883	XHP70D-00-0000-0D0BN40E4
		80				N4	1710	1883	XHP70D-00-0000-0D0HN40E4
						N2	1590	1751	XHP70D-00-0000-0D0HN20E4
						M4	1485	1635	XHP70D-00-0000-0D0HM40E4
		90				M4	1485	1635	XHP70D-00-0000-0D0UM40E4
						M2	1380	1520	XHP70D-00-0000-0D0UM20E4
						K4	1290	1420	XHP70D-00-0000-0D0UK40E4

- Notes**
- Cree LED maintains a tolerance of ±7% on flux and power measurements, ±0.005 on chromaticity (CCx, CCy) measurements and a tolerance of ±2 on CRI measurements. See the Measurements section (page 32).
 - XLamp XHP70.3 LED order codes specify only a minimum flux bin and not a maximum. Cree LED may ship reels in flux bins higher than the minimum specified by the order code without advance notice. Shipments will always adhere to the chromaticity bin restrictions specified by the order code.
 - Flux values @ 25 °C are calculated and for reference only.

FLUX CHARACTERISTICS, HIGH DENSITY ANSI WHITE ORDER CODES AND BINS - CONTINUED

Nominal CCT	Chromaticity Regions	CRI		Minimum Luminous Flux			Order Code
		Min	Typ	Group	Flux (lm) @ 85 °C	Flux (lm) @ 25 °C*	
4000 K	5A, 5B, 5C, 5D	0	68	P2	1830	2015	XHP70D-00-0000-0D00N20E5
				N4	1710	1883	XHP70D-00-0000-0D00N40E5
		70		P4	1965	2164	XHP70D-00-0000-0D0BP40E5
				P2	1830	2015	XHP70D-00-0000-0D0BP20E5
				N4	1710	1883	XHP70D-00-0000-0D0BN40E5
		80		N4	1710	1883	XHP70D-00-0000-0D0HN40E5
				N2	1590	1751	XHP70D-00-0000-0D0HN20E5
				M4	1485	1635	XHP70D-00-0000-0D0HM40E5
		90		M4	1485	1635	XHP70D-00-0000-0D0UM40E5
				M2	1380	1520	XHP70D-00-0000-0D0UM20E5
				K4	1290	1420	XHP70D-00-0000-0D0UK40E5
		3500 K	6A, 6B, 6C, 6D	70		P2	1830
N4	1710					1883	XHP70D-00-0000-0D0BN40E6
N2	1590					1751	XHP70D-00-0000-0D0BN20E6
3000 K	7A, 7B, 7C, 7D	70		N4	1710	1883	XHP70D-00-0000-0D0BN40E7
				N2	1590	1751	XHP70D-00-0000-0D0BN20E7

Notes

- Cree LED maintains a tolerance of ±7% on flux and power measurements, ±0.005 on chromaticity (CCx, CCy) measurements and a tolerance of ±2 on CRI measurements. See the Measurements section (page 32).
- XLamp XHP70.3 LED order codes specify only a minimum flux bin and not a maximum. Cree LED may ship reels in flux bins higher than the minimum specified by the order code without advance notice. Shipments will always adhere to the chromaticity bin restrictions specified by the order code.
- Flux values @ 25 °C are calculated and for reference only.

FLUX CHARACTERISTICS, HIGH DENSITY BROADCAST ORDER CODES AND BINS

The following table provides order codes for XLamp XHP70.3 High Density Broadcast LEDs. For a complete description of how the flux and chromaticity groups are reflected in the bin code and order code nomenclature, please see the Bin and Order Code Formats section (page 30).

Binning condition: $T_j = 85\text{ °C}$; 12 V, $I_f = 1050\text{ mA}$

Reference condition: $T_j = 85\text{ °C}$; 6 V, $I_f = 2100\text{ mA}$

Chromaticity		Minimum Luminous Flux (lm) @ 1050 mA			Order Codes	
Kit	CCT	Flux Bin	Flux (lm) @ 85 °C	Flux (lm) @ 25 °C*	90 CRI Minimum 90 TLCI Minimum	95 CRI Minimum 95 TLCI Minimum
E2	5700 K	M2	1380	1520	XHP70D-00-B001-AD0UM20E2	
		K4	1290	1420		XHP70D-00-B001-AD0ZK40E2

Notes

- TLCI refers to the [European Broadcast Union's Television Lighting Consistency Index 2012](#), which aids broadcasters in assessing the colorimetric quality of lighting in their production environment. Cree LED maintains a tolerance of ± 2 on TLCI measurements. See the Measurements section (page 32).
- Cree LED maintains a tolerance of $\pm 7\%$ on flux and power measurements, ± 0.005 on chromaticity (CCx, CCy) measurements and a tolerance of ± 2 on CRI measurements. See the Measurements section (page 32).
- XLamp XHP70.3 LED order codes specify only a minimum flux bin and not a maximum. Cree LED may ship reels in flux bins higher than the minimum specified by the order code without advance notice. Shipments will always adhere to the chromaticity bin restrictions specified by the order code.
- Flux values @ 25 °C are calculated and for reference only.

FLUX CHARACTERISTICS, HIGH INTENSITY EASYWHITE® ORDER CODES AND BINS

The following table provides order codes for XLamp XHP70.3 High Intensity LEDs. For a complete description of how the flux and chromaticity groups are reflected in the bin code and order code nomenclature, please see the Bin and Order Code Formats section (page 30).

Binning condition: $T_j = 85\text{ }^\circ\text{C}$; 12 V, $I_f = 1050\text{ mA}$
 Reference condition: $T_j = 85\text{ }^\circ\text{C}$; 6 V, $I_f = 2100\text{ mA}$

Nominal CCT	CRI		Minimum Luminous Flux			2-Step		3-Step		5-Step	
	Min	Typ	Group	Flux (lm) @ 85 °C	Flux (lm) @ 25 °C*	Group	Order Code	Group	Order Code	Group	Order Code
5000 K	70		P2	1830	2015					50E	XHP70D-H0-0000-0D0BP250E
			N4	1710	1883				XHP70D-H0-0000-0D0BN450E		
	80		N2	1590	1751			50G	XHP70D-H0-0000-0D0HN250G		
			M4	1485	1635				XHP70D-H0-0000-0D0HM450G		
	90		M4	1485	1635			50G	XHP70D-H0-0000-0D0UM450G		
			M2	1380	1520				XHP70D-H0-0000-0D0UM250G		
4500 K	70		P2	1830	2015					45E	XHP70D-H0-0000-0D0BP245E
			N4	1710	1883				XHP70D-H0-0000-0D0BN445E		
	80		N2	1590	1751			45G	XHP70D-H0-0000-0D0HN245G		
			M4	1485	1635				XHP70D-H0-0000-0D0HM445G		
	90		M2	1380	1520			45G	XHP70D-H0-0000-0D0UM245G		
			K4	1290	1420				XHP70D-H0-0000-0D0UK445G		

- Notes**
- Cree LED maintains a tolerance of $\pm 7\%$ on flux and power measurements, ± 0.005 on chromaticity (CCx, CCy) measurements and a tolerance of ± 2 on CRI measurements. See the Measurements section (page 32).
 - XLamp XHP70.3 LED order codes specify only a minimum flux bin and not a maximum. Cree LED may ship reels in flux bins higher than the minimum specified by the order code without advance notice. Shipments will always adhere to the chromaticity bin restrictions specified by the order code.
 - Flux values @ 25 °C are calculated and for reference only.

FLUX CHARACTERISTICS, HIGH INTENSITY EASYWHITE® ORDER CODES AND BINS - CONTINUED

Nominal CCT	CRI		Minimum Luminous Flux			2-Step		3-Step		5-Step		
	Min	Typ	Group	Flux (lm) @ 85 °C	Flux (lm) @ 25 °C*	Group	Order Code	Group	Order Code	Group	Order Code	
4000 K	70		P2	1830	2015					40E	XHP70D-H0-0000-0D0BP240E	
			N4	1710	1883		XHP70D-H0-0000-0D0BN440E					
	80		N2	1590	1751	40H	XHP70D-H0-0000-0D0HN240H	40G	XHP70D-H0-0000-0D0HN240G			
			M4	1485	1635	XHP70D-H0-0000-0D0HM440H	XHP70D-H0-0000-0D0HM440G					
	90		M2	1380	1520	40H	XHP70D-H0-0000-0D0UM240H	40G	XHP70D-H0-0000-0D0UM240G			
			K4	1290	1420	XHP70D-H0-0000-0D0UK440H	XHP70D-H0-0000-0D0UK440G					
	95		K4	1290	1420	40H	XHP70D-H0-0000-0D0ZK440H	40G	XHP70D-H0-0000-0D0ZK440G			
			K2	1200	1321		XHP70D-H0-0000-0D0ZK240H		XHP70D-H0-0000-0D0ZK240G			
			J4	1120	1233		XHP70D-H0-0000-0D0ZJ440H		XHP70D-H0-0000-0D0ZJ440G			
	3500 K	70		N4	1710	1883					35E	XHP70D-H0-0000-0D0BN435E
				N2	1590	1751		XHP70D-H0-0000-0D0BN235E				
		80		N2	1590	1751	35H	XHP70D-H0-0000-0D0HN235H	35G	XHP70D-H0-0000-0D0HN235G		
M4				1485	1635	XHP70D-H0-0000-0D0HM435H	XHP70D-H0-0000-0D0HM435G					
90			K4	1290	1420	35H	XHP70D-H0-0000-0D0UK435H	35G	XHP70D-H0-0000-0D0UK435G			
			K2	1200	1321	XHP70D-H0-0000-0D0UK235H	XHP70D-H0-0000-0D0UK235G					
95			K2	1200	1321	35H	XHP70D-H0-0000-0D0ZK235H	35G	XHP70D-H0-0000-0D0ZK235G			
			J4	1120	1233		XHP70D-H0-0000-0D0ZJ435H		XHP70D-H0-0000-0D0ZJ435G			
			J2	1040	1145		XHP70D-H0-0000-0D0ZJ235H		XHP70D-H0-0000-0D0ZJ235G			
			H4	970	1068		XHP70D-H0-0000-0D0ZH435H		XHP70D-H0-0000-0D0ZH435G			

- Notes**
- Cree LED maintains a tolerance of ±7% on flux and power measurements, ±0.005 on chromaticity (CCx, CCy) measurements and a tolerance of ±2 on CRI measurements. See the Measurements section (page 32).
 - XLamp XHP70.3 LED order codes specify only a minimum flux bin and not a maximum. Cree LED may ship reels in flux bins higher than the minimum specified by the order code without advance notice. Shipments will always adhere to the chromaticity bin restrictions specified by the order code.
 - Flux values @ 25 °C are calculated and for reference only.

FLUX CHARACTERISTICS, HIGH INTENSITY EASYWHITE® ORDER CODES AND BINS - CONTINUED

Nominal CCT	CRI		Minimum Luminous Flux			2-Step		3-Step		5-Step		
	Min	Typ	Group	Flux (lm) @ 85 °C	Flux (lm) @ 25 °C*	Group	Order Code	Group	Order Code	Group	Order Code	
3000 K	70		N4	1710	1883					30E	XHP70D-H0-0000-0D0BN430E	
			N2	1590	1751		XHP70D-H0-0000-0D0BN230E					
	80		N2	1590	1751	30H	XHP70D-H0-0000-0D0HN230H	30G	XHP70D-H0-0000-0D0HN230G			
			M4	1485	1635	XHP70D-H0-0000-0D0HM430H	XHP70D-H0-0000-0D0HM430G					
	90		K4	1290	1420	30H	XHP70D-H0-0000-0D0UK430H	30G	XHP70D-H0-0000-0D0UK430G			
			K2	1200	1321		XHP70D-H0-0000-0D0UK230H		XHP70D-H0-0000-0D0UK230G			
	95		K2	1200	1321	30H	XHP70D-H0-0000-0D0ZK230H	30G	XHP70D-H0-0000-0D0ZK230G			
			J4	1120	1233		XHP70D-H0-0000-0D0ZJ430H		XHP70D-H0-0000-0D0ZJ430G			
			J2	1040	1145		XHP70D-H0-0000-0D0ZJ230H		XHP70D-H0-0000-0D0ZJ230G			
			H4	970	1068		XHP70D-H0-0000-0D0ZH430H		XHP70D-H0-0000-0D0ZH430G			
	2700 K	80		M4	1485	1635	27H	XHP70D-H0-0000-0D0HM427H	27G	XHP70D-H0-0000-0D0HM427G		
				M2	1380	1520		XHP70D-H0-0000-0D0HM227H		XHP70D-H0-0000-0D0HM227G		
90			K2	1200	1321	27H	XHP70D-H0-0000-0D0UK227H	27G	XHP70D-H0-0000-0D0UK227G			
			J4	1120	1233		XHP70D-H0-0000-0D0UJ427H		XHP70D-H0-0000-0D0UJ427G			
95			J4	1120	1233	27H	XHP70D-H0-0000-0D0ZJ427H	27G	XHP70D-H0-0000-0D0ZJ427G			
			J2	1040	1145		XHP70D-H0-0000-0D0ZJ227H		XHP70D-H0-0000-0D0ZJ227G			
			H4	970	1068		XHP70D-H0-0000-0D0ZH427H		XHP70D-H0-0000-0D0ZH427G			
			H2	900	991		XHP70D-H0-0000-0D0ZH227H		XHP70D-H0-0000-0D0ZH227G			

- Notes**
- Cree LED maintains a tolerance of ±7% on flux and power measurements, ±0.005 on chromaticity (CCx, CCy) measurements and a tolerance of ±2 on CRI measurements. See the Measurements section (page 32).
 - XLamp XHP70.3 LED order codes specify only a minimum flux bin and not a maximum. Cree LED may ship reels in flux bins higher than the minimum specified by the order code without advance notice. Shipments will always adhere to the chromaticity bin restrictions specified by the order code.
 - Flux values @ 25 °C are calculated and for reference only.

FLUX CHARACTERISTICS, HIGH INTENSITY ANSI WHITE ORDER CODES AND BINS

The following table provides order codes for XLamp XHP70.3 High Intensity LEDs. For a complete description of how the flux and chromaticity groups are reflected in the bin code and order code nomenclature, please see the Bin and Order Code Formats section (page 30).

Binning condition: $T_j = 85\text{ °C}$; 12 V, $I_f = 1050\text{ mA}$

Reference condition: $T_j = 85\text{ °C}$; 6 V, $I_f = 2100\text{ mA}$

Nominal CCT	Chromaticity Regions	CRI		Minimum Luminous Flux			Order Code		
		Min	Typ	Group	Flux (lm) @ 85 °C	Flux (lm) @ 25 °C*			
7000 K	0A, 0B, 0C, 0D, 0R, 0S, 0T, 0U, 1A, 1B, 1C, 1D, 1R, 1S, 1T, 1U	0	68	P2	1830	2015	XHP70D-H0-0000-0D00P20DT		
				N4	1710	1883	XHP70D-H0-0000-0D00N40DT		
				N2	1590	1751	XHP70D-H0-0000-0D00N20DT		
		70		P2	1830	2015	XHP70D-H0-0000-0D0BP20DT		
				N4	1710	1883	XHP70D-H0-0000-0D0BN40DT		
				N2	1590	1751	XHP70D-H0-0000-0D0BN20DT		
		80		N2	1590	1751	XHP70D-H0-0000-0D0HN20DT		
				M4	1485	1635	XHP70D-H0-0000-0D0HM40DT		
		6500 K	1A, 1B, 1C, 1D	0	68	P2	1830	2015	XHP70D-H0-0000-0D00P20E1
N4	1710					1883	XHP70D-H0-0000-0D00N40E1		
N2	1590					1751	XHP70D-H0-0000-0D00N20E1		
70				N4	1710	1883	XHP70D-H0-0000-0D0BN40E1		
				N2	1590	1751	XHP70D-H0-0000-0D0BN20E1		
80				N2	1590	1751	XHP70D-H0-0000-0D0HN20E1		
				M4	1485	1635	XHP70D-H0-0000-0D0HM40E1		
6000 K	1A, 1B, 1C, 1D, 1R, 1S, 1T, 1U, 2A, 2B, 2C, 2D, 2R, 2S, 2T, 2U			0	68	P2	1830	2015	XHP70D-H0-0000-0D00P20DV
						N4	1710	1883	XHP70D-H0-0000-0D00N40DV
		70		P2	1830	2015	XHP70D-H0-0000-0D0BP20DV		
				N4	1710	1883	XHP70D-H0-0000-0D0BN40DV		
		80		N2	1590	1751	XHP70D-H0-0000-0D0HN20DV		
				M4	1485	1635	XHP70D-H0-0000-0D0HM40DV		
		90		M4	1485	1635	XHP70D-H0-0000-0D0UM40DV		
				M2	1380	1520	XHP70D-H0-0000-0D0UM20DV		

- Notes
- Cree LED maintains a tolerance of $\pm 7\%$ on flux and power measurements, ± 0.005 on chromaticity (CCx, CCy) measurements and a tolerance of ± 2 on CRI measurements. See the Measurements section (page 32).
 - XLamp XHP70.3 LED order codes specify only a minimum flux bin and not a maximum. Cree LED may ship reels in flux bins higher than the minimum specified by the order code without advance notice. Shipments will always adhere to the chromaticity bin restrictions specified by the order code.
 - Flux values @ 25 °C are calculated and for reference only.

FLUX CHARACTERISTICS, HIGH INTENSITY ANSI WHITE ORDER CODES AND BINS - CONTINUED

Nominal CCT	Chromaticity Regions	CRI		Minimum Luminous Flux			Order Code
		Min	Typ	Group	Flux (lm) @ 85 °C	Flux (lm) @ 25 °C*	
5700 K	2A, 2B, 2C, 2D	0	68	P2	1830	2015	XHP70D-H0-0000-0D00P20E2
				N4	1710	1883	XHP70D-H0-0000-0D00N40E2
		70		P2	1830	2015	XHP70D-H0-0000-0D0BP20E2
				N4	1710	1883	XHP70D-H0-0000-0D0BN40E2
		80		N2	1590	1751	XHP70D-H0-0000-0D0HN20E2
				M4	1485	1635	XHP70D-H0-0000-0D0HM40E2
		90		M4	1485	1635	XHP70D-H0-0000-0D0UM40E2
				M2	1380	1520	XHP70D-H0-0000-0D0UM20E2
5000 K	3A, 3B, 3C, 3D	0	68	P2	1830	2015	XHP70D-H0-0000-0D00P20E3
				N4	1710	1883	XHP70D-H0-0000-0D00N40E3
		70		P2	1830	2015	XHP70D-H0-0000-0D0BP20E3
				N4	1710	1883	XHP70D-H0-0000-0D0BN40E3
		80		N2	1590	1751	XHP70D-H0-0000-0D0HN20E3
				M4	1485	1635	XHP70D-H0-0000-0D0HM40E3
		90		M4	1485	1635	XHP70D-H0-0000-0D0UM40E3
				M2	1380	1520	XHP70D-H0-0000-0D0UM20E3
4500 K	4A, 4B, 4C, 4D	0	68	P2	1830	2015	XHP70D-H0-0000-0D00P20E4
				N4	1710	1883	XHP70D-H0-0000-0D00N40E4
		70		P2	1830	2015	XHP70D-H0-0000-0D0BP20E4
				N4	1710	1883	XHP70D-H0-0000-0D0BN40E4
		80		N2	1590	1751	XHP70D-H0-0000-0D0HN20E4
				M4	1485	1635	XHP70D-H0-0000-0D0HM40E4
		90		M2	1380	1520	XHP70D-H0-0000-0D0UM20E4
				K4	1290	1420	XHP70D-H0-0000-0D0UK40E4
4000 K	5A, 5B, 5C, 5D	0	68	P2	1830	2015	XHP70D-H0-0000-0D00N20E5
				N4	1710	1883	XHP70D-H0-0000-0D00N40E5
		70		P2	1830	2015	XHP70D-H0-0000-0D0BP20E5
				N4	1710	1883	XHP70D-H0-0000-0D0BN40E5
		80		N2	1590	1751	XHP70D-H0-0000-0D0HN20E5
				M4	1485	1635	XHP70D-H0-0000-0D0HM40E5
		90		M2	1380	1520	XHP70D-H0-0000-0D0UM20E5
				K4	1290	1420	XHP70D-H0-0000-0D0UK40E5
3500 K	6A, 6B, 6C, 6D	70		N4	1710	1883	XHP70D-H0-0000-0D0BN40E6
				N2	1590	1751	XHP70D-H0-0000-0D0BN20E6
3000 K	7A, 7B, 7C, 7D	70		N4	1710	1883	XHP70D-H0-0000-0D0BN40E7
				N2	1590	1751	XHP70D-H0-0000-0D0BN20E7

- Notes**
- Cree LED maintains a tolerance of ±7% on flux and power measurements, ±0.005 on chromaticity (CCx, CCy) measurements and a tolerance of ±2 on CRI measurements. See the Measurements section (page 32).
 - XLamp XHP70.3 LED order codes specify only a minimum flux bin and not a maximum. Cree LED may ship reels in flux bins higher than the minimum specified by the order code without advance notice. Shipments will always adhere to the chromaticity bin restrictions specified by the order code.
 - Flux values @ 25 °C are calculated and for reference only.

FLUX CHARACTERISTICS, HIGH INTENSITY BROADCAST ORDER CODES AND BINS

The following table provides order codes for XLamp XHP70.3 High Intensity Broadcast LEDs. For a complete description of how the flux and chromaticity groups are reflected in the bin code and order code nomenclature, please see the Bin and Order Code Formats section (page 30).

Binning condition: $T_j = 85\text{ °C}$; 12 V, $I_f = 1050\text{ mA}$

Reference condition: $T_j = 85\text{ °C}$; 6 V, $I_f = 2100\text{ mA}$

Chromaticity		Minimum Luminous Flux (lm) @ 1050 mA			Order Codes	
Kit	CCT	Flux Bin	Flux (lm) @ 85 °C	Flux (lm) @ 25 °C*	90 CRI Minimum 90 TLCI Minimum	95 CRI Minimum 95 TLCI Minimum
E2	5700 K	K4	1290	1420	XHP70D-H0-B001-AD0UK40E2	
		K2	1200	1321		

Notes

- TLCI refers to the [European Broadcast Union's Television Lighting Consistency Index 2012](#), which aids broadcasters in assessing the colorimetric quality of lighting in their production environment. Cree LED maintains a tolerance of ± 2 on TLCI measurements. See the Measurements section (page 32).
- Cree LED maintains a tolerance of $\pm 7\%$ on flux and power measurements, ± 0.005 on chromaticity (CCx, CCy) measurements and a tolerance of ± 2 on CRI measurements. See the Measurements section (page 32).
- XLamp XHP70.3 LED order codes specify only a minimum flux bin and not a maximum. Cree LED may ship reels in flux bins higher than the minimum specified by the order code without advance notice. Shipments will always adhere to the chromaticity bin restrictions specified by the order code.
- Flux values @ 25 °C are calculated and for reference only.

RELATIVE SPECTRAL POWER DISTRIBUTION

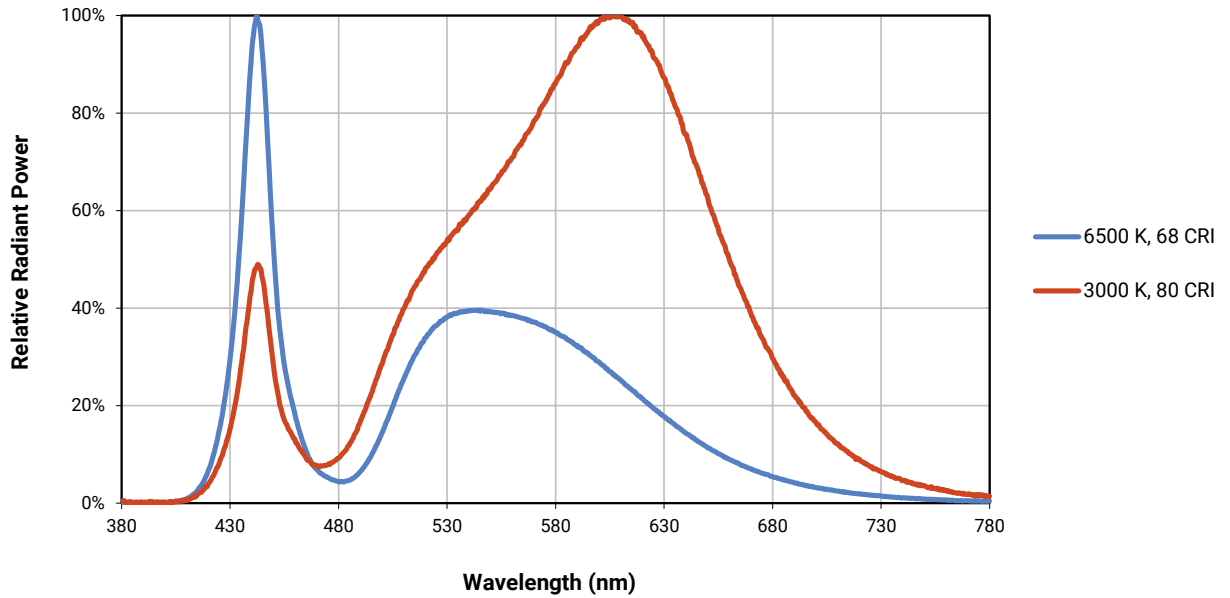

RELATIVE FLUX VS. JUNCTION TEMPERATURE

Reference condition: 6 V, $I_f = 2100$ mA; 12 V, $I_f = 1050$ mA

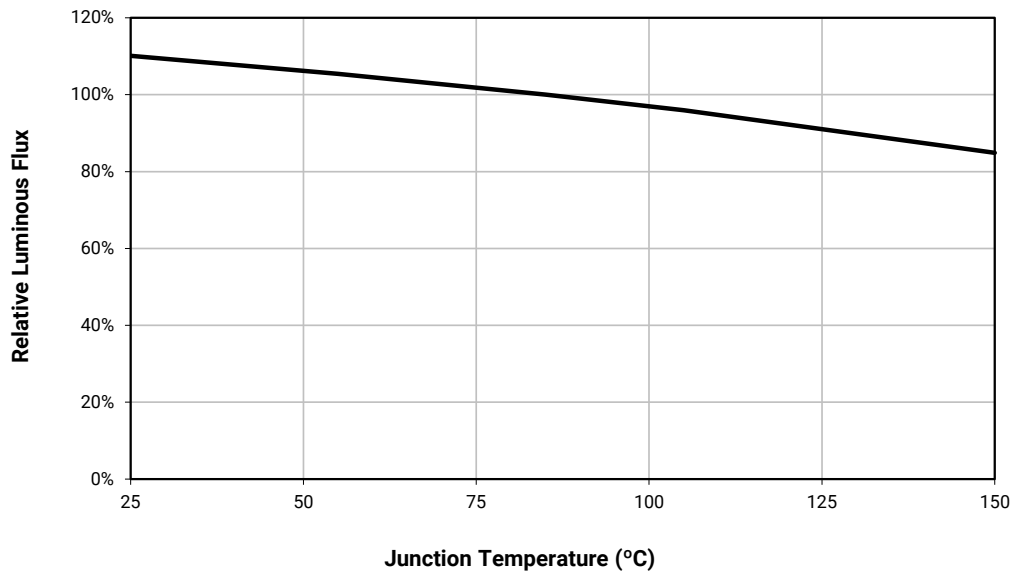

ELECTRICAL CHARACTERISTICS (T_j = 85 °C)

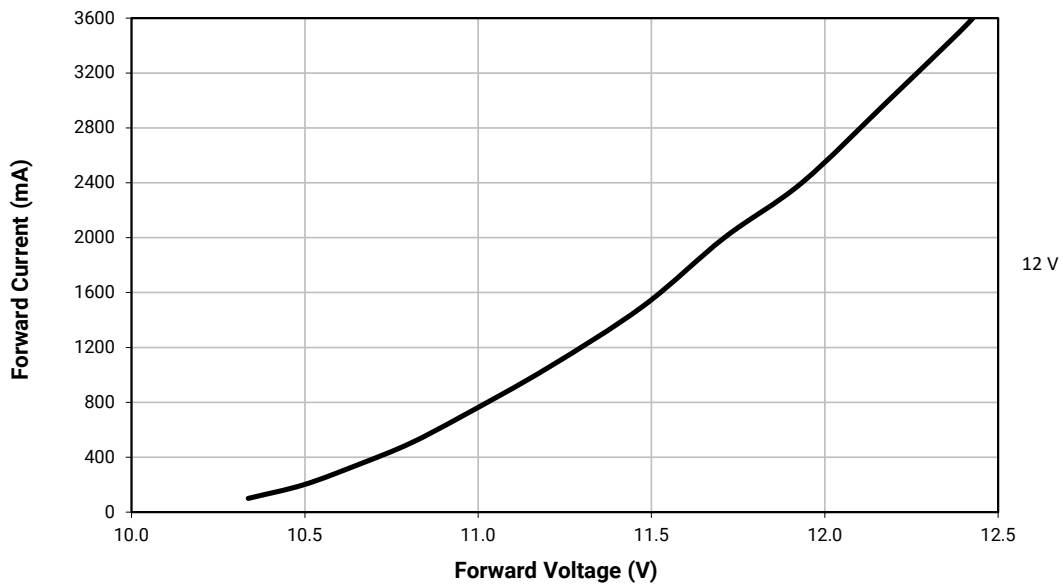
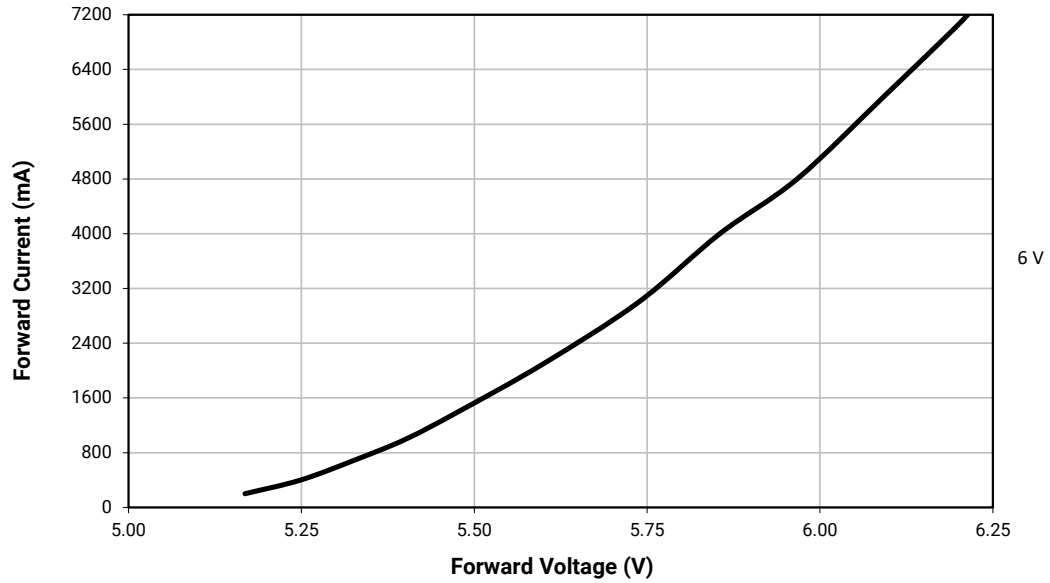

RELATIVE FLUX VS. CURRENT ($T_j = 85\text{ }^\circ\text{C}$)

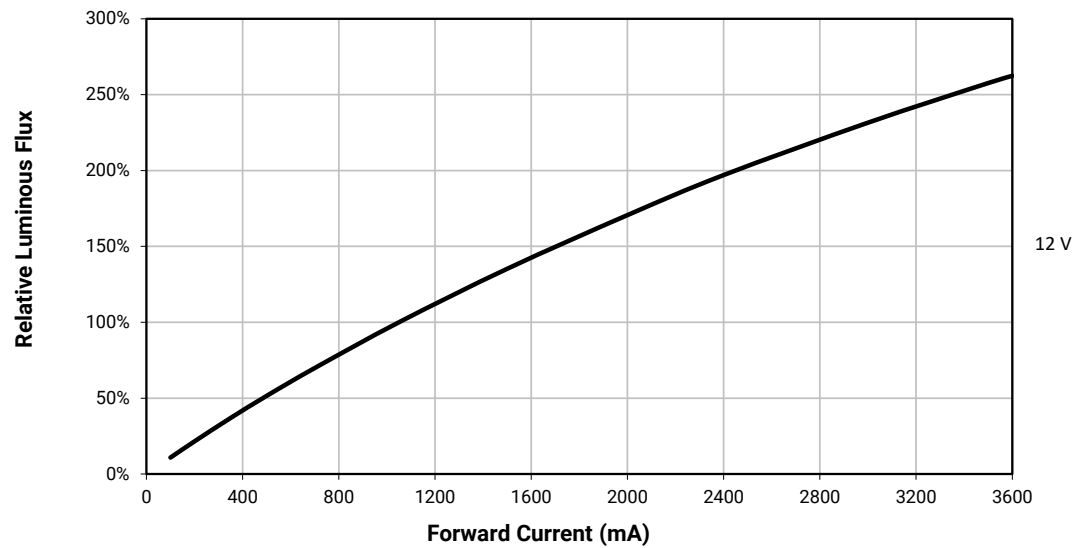
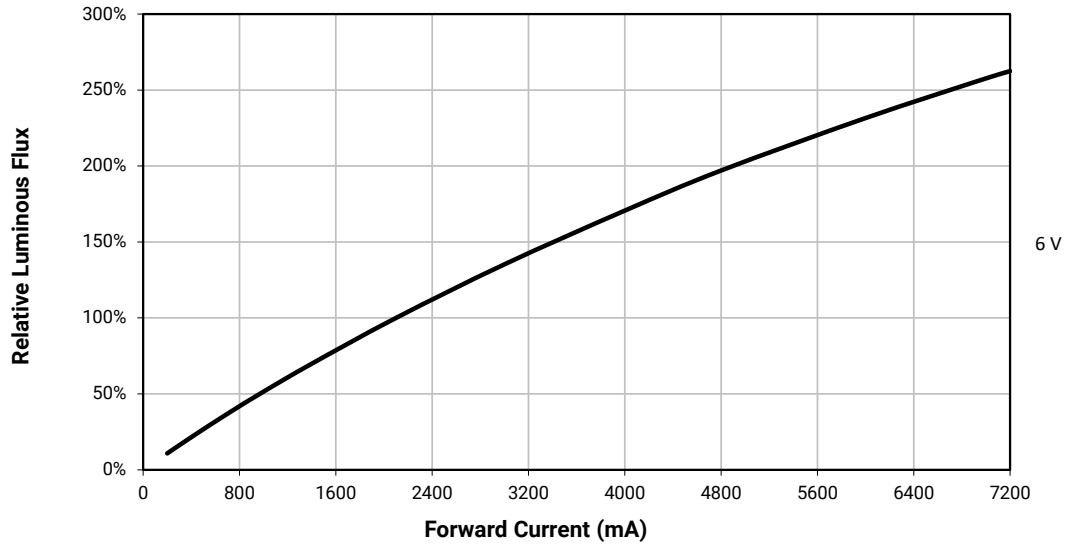

RELATIVE CHROMATICITY VS CURRENT (WARM WHITE)

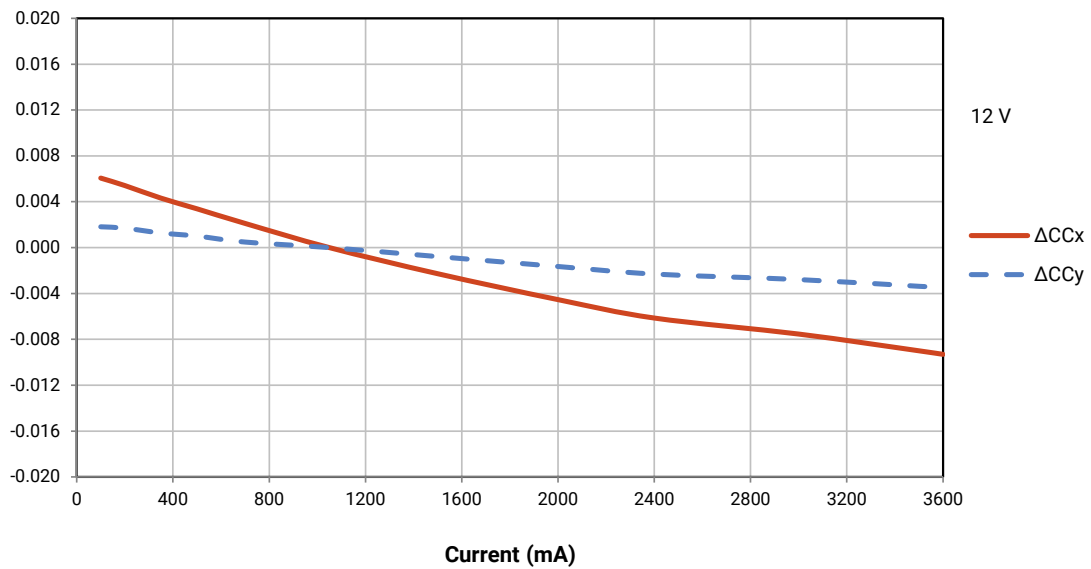
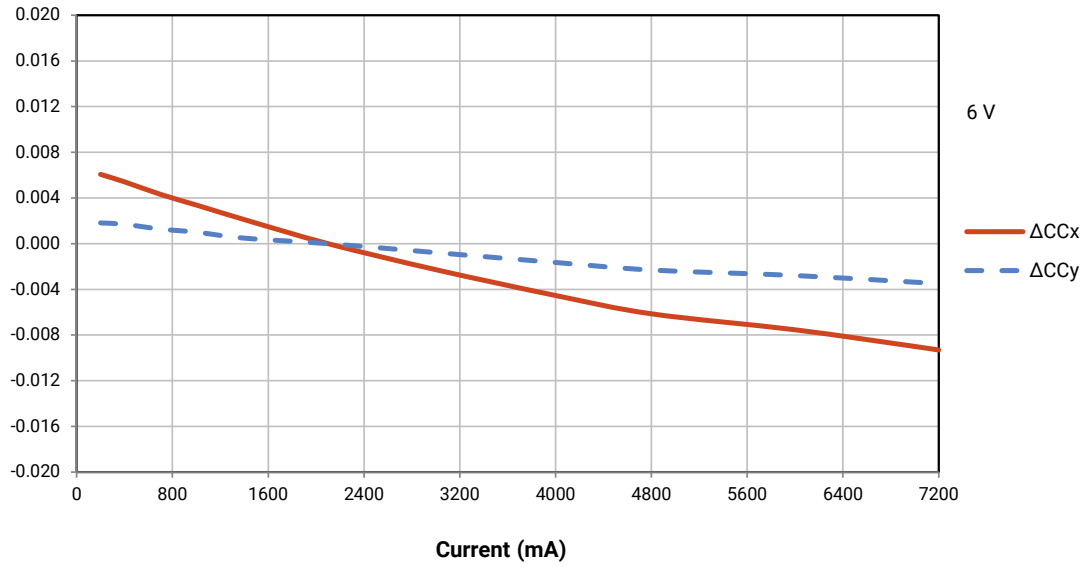

RELATIVE CHROMATICITY VS TEMPERATURE (WARM WHITE)

Reference condition: 6 V, $I_F = 2100$ mA; 12 V, $I_F = 1050$ mA

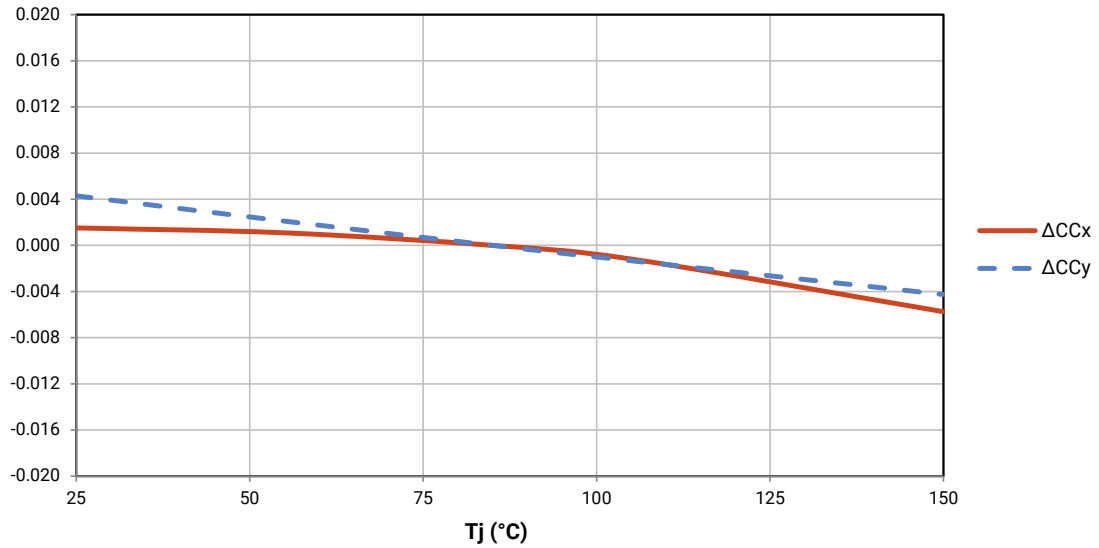

TYPICAL SPATIAL DISTRIBUTION

Reference condition: $T_j = 85$ °C; 6 V, $I_F = 2100$ mA; 12 V, $I_F = 1050$ mA

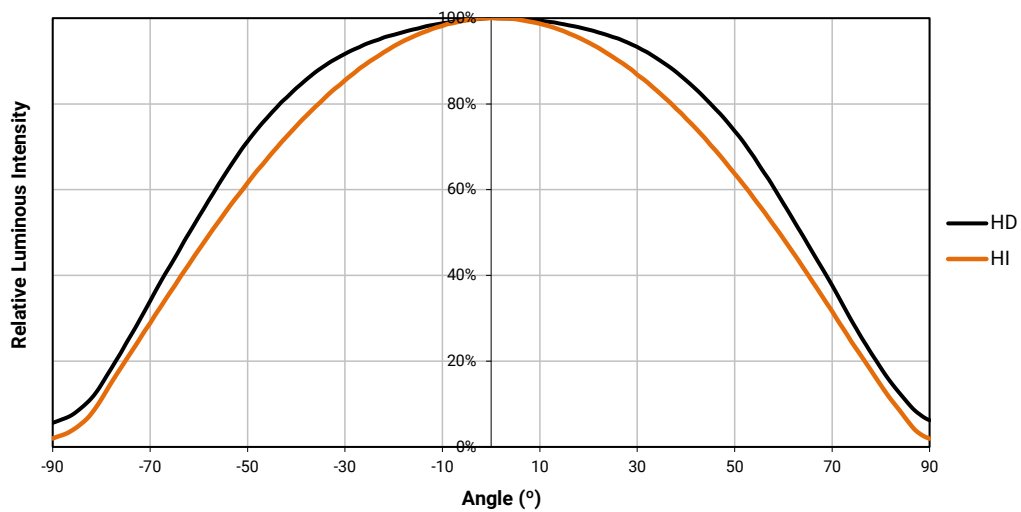

THERMAL DESIGN

The maximum forward current is determined by the thermal resistance between the LED junction and ambient. It is crucial for the end product to be designed in a manner that minimizes the thermal resistance from the solder point to ambient in order to optimize lamp life and optical characteristics.

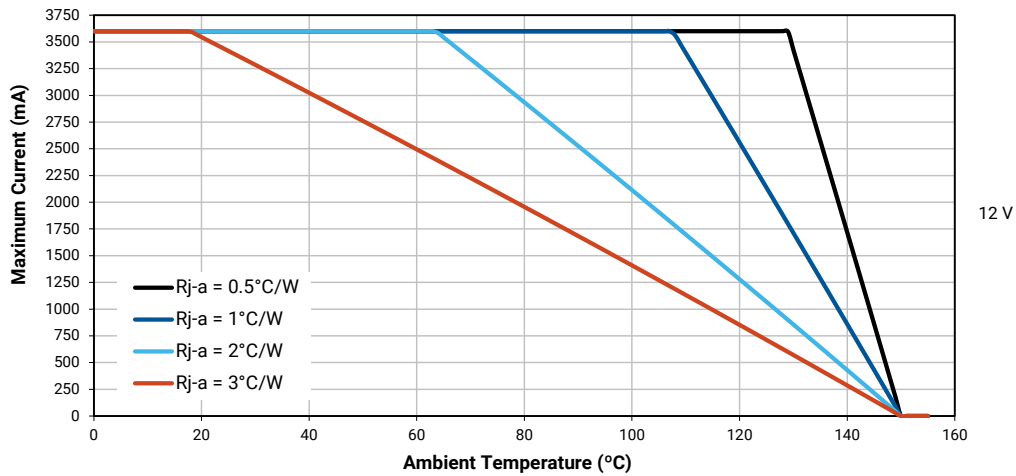
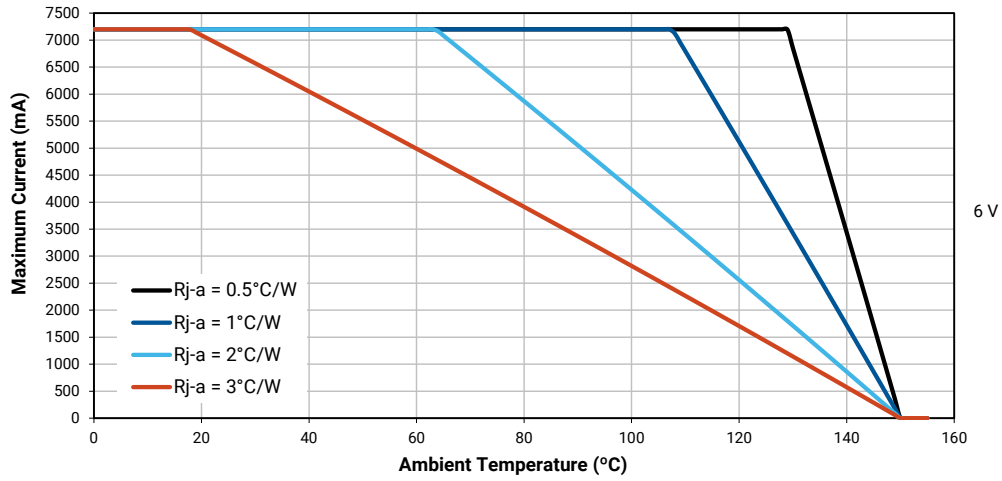

PERFORMANCE GROUPS - LUMINOUS FLUX (T_j = 85 °C)

XLamp XHP70.3 LEDs are tested for luminous flux and placed into one of the following luminous-flux groups.

Group Code	Minimum Luminous Flux	Maximum Luminous Flux
H2	900	970
H4	970	1040
J2	1040	1120
J4	1120	1200
K2	1200	1290
K4	1290	1380
M2	1380	1485
M4	1485	1590
N2	1590	1710
N4	1710	1830
P2	1830	1965
P4	1965	2100
Q2	2100	2260

PERFORMANCE GROUPS - CHROMATICITY

XLamp XHP70.3 LEDs are tested for chromaticity and placed into one of the regions defined by the following bounding coordinates.

EasyWhite Color Temperatures – 2-Step			
Code	CCT	x	y
40H	4000 K	0.3777	0.3739
		0.3797	0.3816
		0.3861	0.3855
		0.3838	0.3777
35H	3500 K	0.4022	0.3858
		0.4053	0.3942
		0.4125	0.3977
		0.4091	0.3891
30H	3000 K	0.4287	0.3975
		0.4328	0.4064
		0.4390	0.4086
		0.4347	0.3996
27H	2700 K	0.4524	0.4048
		0.4574	0.4140
		0.4633	0.4154
		0.4581	0.4062

PERFORMANCE GROUPS - CHROMATICITY (CONTINUED)

EasyWhite Color Temperatures – 3-Step Ellipse						
Bin Code	CCT	Center Point		Major Axis	Minor Axis	Rotation Angle (°)
		x	y	a	b	
50G	5000 K	0.3447	0.3553	0.00840	0.00312	65.0
45G	4500 K	0.3611	0.3658	0.00852	0.00330	61.5
40G	4000 K	0.3818	0.3797	0.00939	0.00402	53.7
35G	3500 K	0.4073	0.3917	0.00927	0.00414	54.0
30G	3000 K	0.4338	0.4030	0.00834	0.00408	53.2
27G	2700 K	0.4577	0.4099	0.00834	0.00420	48.5

EasyWhite Color Temperatures – 5-Step Ellipse						
Bin Code	CCT	Center Point		Major Axis	Minor Axis	Rotation Angle (°)
		x	y	a	b	
50E	5000 K	0.3447	0.3553	0.01400	0.00520	65.0
45E	4500 K	0.3611	0.3658	0.01420	0.00550	61.5
40E	4000 K	0.3818	0.3797	0.01565	0.00670	53.7
35E	3500 K	0.4073	0.3917	0.01545	0.00690	54.0
30E	3000 K	0.4338	0.4030	0.01390	0.00680	53.2

ANSI White Bins			
CCT	Bin Code	x	y
7000 K	0A0	0.2950	0.2970
		0.2920	0.3060
		0.2984	0.3133
		0.3009	0.3042
	0B0	0.2920	0.3060
		0.2895	0.3135
		0.2962	0.3220
		0.2984	0.3133
	0C0	0.2984	0.3133
		0.2962	0.3220
		0.3028	0.3304
		0.3048	0.3207
	0D0	0.2984	0.3133
		0.3048	0.3207
		0.3068	0.3113
		0.3009	0.3042

ANSI White Bins			
CCT	Bin Code	x	y
7000 K	0R0	0.2980	0.2880
		0.2950	0.2970
		0.3009	0.3042
		0.3037	0.2937
	0S0	0.2895	0.3135
		0.2870	0.3210
		0.2937	0.3312
		0.2962	0.3220
	0T0	0.2962	0.3220
		0.2937	0.3312
		0.3005	0.3415
		0.3028	0.3304
	0U0	0.3037	0.2937
		0.3009	0.3042
		0.3068	0.3113
		0.3093	0.2993

ANSI White Bins			
CCT	Bin Code	x	y
7000 K	1A0	0.3048	0.3207
		0.3130	0.3290
		0.3144	0.3186
		0.3068	0.3113
	1B0	0.3028	0.3304
		0.3115	0.3391
		0.3130	0.3290
		0.3048	0.3207
	1C0	0.3115	0.3391
		0.3205	0.3481
		0.3213	0.3373
		0.3130	0.3290
	1D0	0.3130	0.3290
		0.3213	0.3373
		0.3221	0.3261
		0.3144	0.3186

PERFORMANCE GROUPS - CHROMATICITY (CONTINUED)

ANSI White Bins			
CCT	Bin Code	x	y
7000 K	1R0	0.3068	0.3113
		0.3144	0.3186
		0.3161	0.3059
		0.3093	0.2993
	1S0	0.3005	0.3415
		0.3099	0.3509
		0.3115	0.3391
		0.3028	0.3304
	1T0	0.3099	0.3509
		0.3196	0.3602
		0.3205	0.3481
		0.3115	0.3391
	1U0	0.3144	0.3186
		0.3221	0.3261
		0.3231	0.3120
		0.3161	0.3059

ANSI White Bins			
CCT	Bin Code	x	y
6000 K	2A0	0.3215	0.3350
		0.3290	0.3417
		0.3290	0.3300
		0.3222	0.3243
	2B0	0.3207	0.3462
		0.3290	0.3538
		0.3290	0.3417
		0.3215	0.3350
	2C0	0.3290	0.3538
		0.3376	0.3616
		0.3371	0.3490
		0.3290	0.3417
	2D0	0.3290	0.3417
		0.3371	0.3490
		0.3366	0.3369
		0.3290	0.3300

ANSI White Bins			
CCT	Bin Code	x	y
6000 K	2R0	0.3222	0.3243
		0.3290	0.3300
		0.3290	0.3180
		0.3231	0.3120
	2S0	0.3196	0.3602
		0.3290	0.3690
		0.3290	0.3538
		0.3207	0.3462
	2T0	0.3290	0.3690
		0.3381	0.3762
		0.3376	0.3616
		0.3290	0.3538
	2U0	0.3290	0.3300
		0.3366	0.3369
		0.3361	0.3245
		0.3290	0.3180

ANSI White Bins			
CCT	Bin Code	x	y
5000 K	3A0	0.3371	0.3490
		0.3451	0.3554
		0.3440	0.3427
		0.3366	0.3369
	3B0	0.3376	0.3616
		0.3463	0.3687
		0.3451	0.3554
		0.3371	0.3490
	3C0	0.3463	0.3687
		0.3551	0.3760
		0.3533	0.3620
		0.3451	0.3554
	3D0	0.3451	0.3554
		0.3533	0.3620
		0.3515	0.3487
		0.3440	0.3427

ANSI White Bins			
CCT	Bin Code	x	y
4500 K	4A0	0.3530	0.3597
		0.3615	0.3659
		0.3512	0.3465
		0.3515	0.3487
	4B0	0.3548	0.3736
		0.3641	0.3804
		0.3530	0.3597
		0.3533	0.362
	4C0	0.3641	0.3804
		0.3736	0.3874
		0.3702	0.3722
		0.3615	0.3659
	4D0	0.3615	0.3659
		0.3702	0.3722
		0.3670	0.3578
		0.3590	0.3521

PERFORMANCE GROUPS - CHROMATICITY (CONTINUED)

ANSI White Bins			
CCT	Bin Code	x	y
4000 K	5A0	0.3670	0.3578
		0.3702	0.3722
		0.3825	0.3798
		0.3783	0.3646
	5B0	0.3702	0.3722
		0.3736	0.3874
		0.3869	0.3958
		0.3825	0.3798
	5C0	0.3825	0.3798
		0.3869	0.3958
		0.4006	0.4044
		0.3950	0.3875
	5D0	0.3783	0.3646
		0.3825	0.3798
		0.3950	0.3875
		0.3898	0.3716

ANSI White Bins			
CCT	Bin Code	x	y
3500 K	6A0	0.3889	0.3690
		0.3941	0.3848
		0.4080	0.3916
		0.4017	0.3751
	6B0	0.3941	0.3848
		0.3996	0.4015
		0.4146	0.4089
		0.4080	0.3916
	6C0	0.4080	0.3916
		0.4146	0.4089
		0.4299	0.4165
		0.4221	0.3984
	6D0	0.4017	0.3751
		0.4080	0.3916
		0.4221	0.3984
		0.4147	0.3814

ANSI White Bins			
CCT	Bin Code	x	y
3000 K	7A0	0.4147	0.3814
		0.4221	0.3984
		0.4342	0.4028
		0.4259	0.3853
	7B0	0.4221	0.3984
		0.4299	0.4165
		0.4430	0.4212
		0.4342	0.4028
	7C0	0.4342	0.4028
		0.4430	0.4212
		0.4562	0.4260
		0.4465	0.4071
	7D0	0.4259	0.3853
		0.4342	0.4028
		0.4465	0.4071
		0.4373	0.3893

EASYWHITE® CHROMATICITY REGIONS PLOTTED ON THE 1931 CIE CURVE

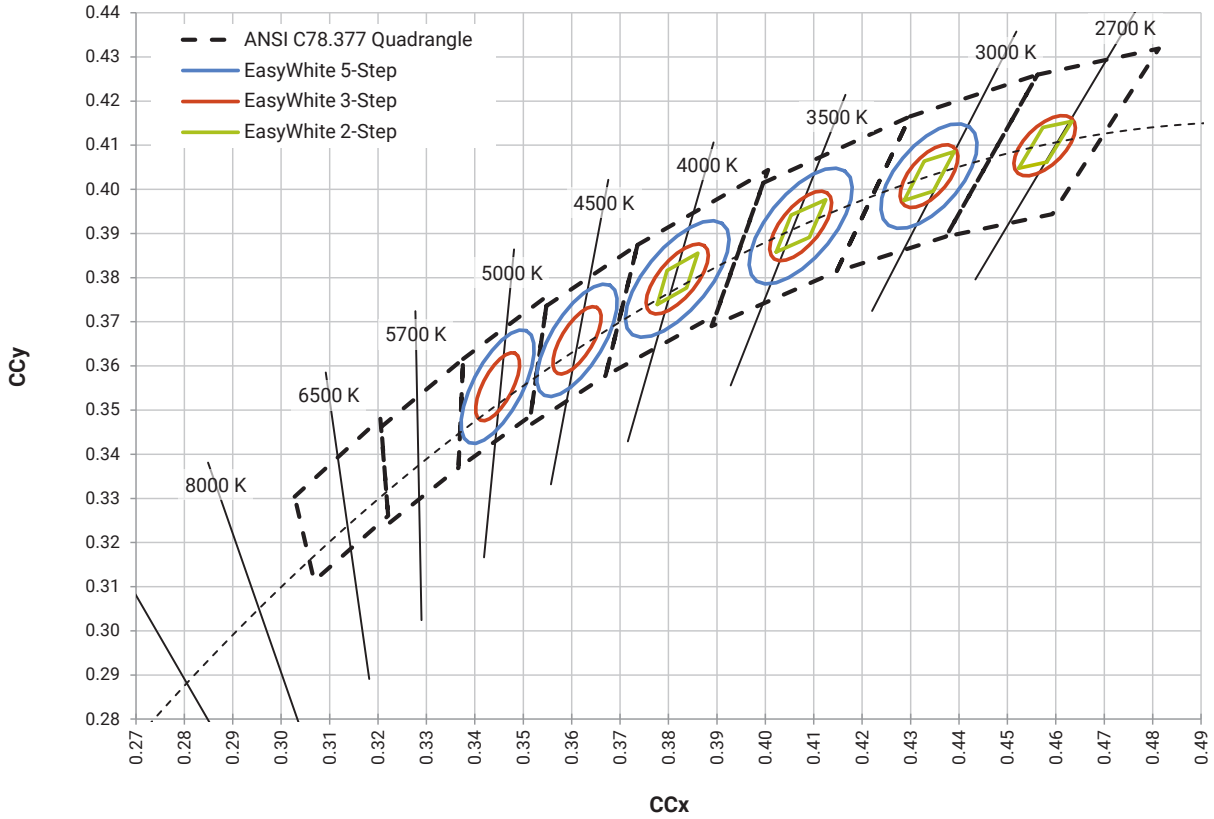

ANSI STANDARD COOL WHITE KITS PLOTTED ON ANSI STANDARD CHROMATICITY REGIONS

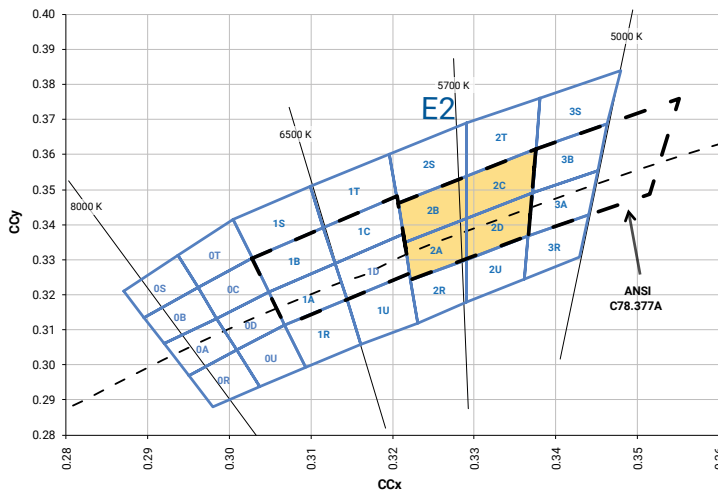
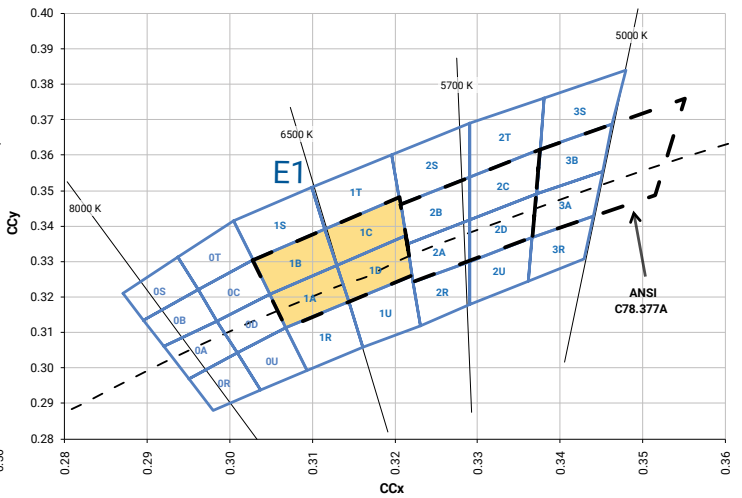
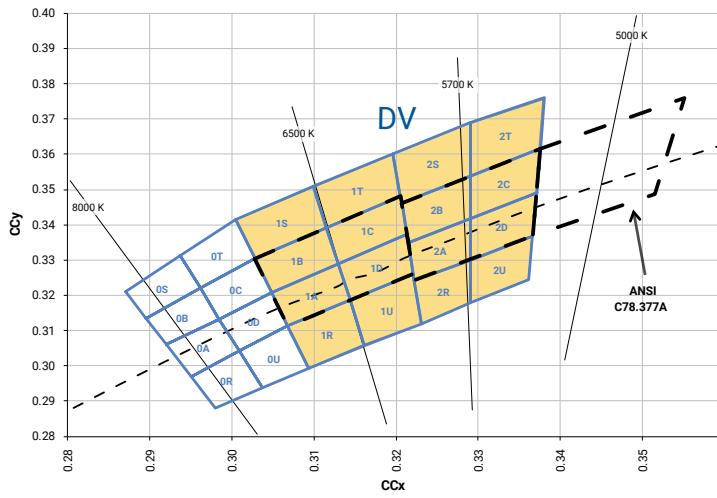
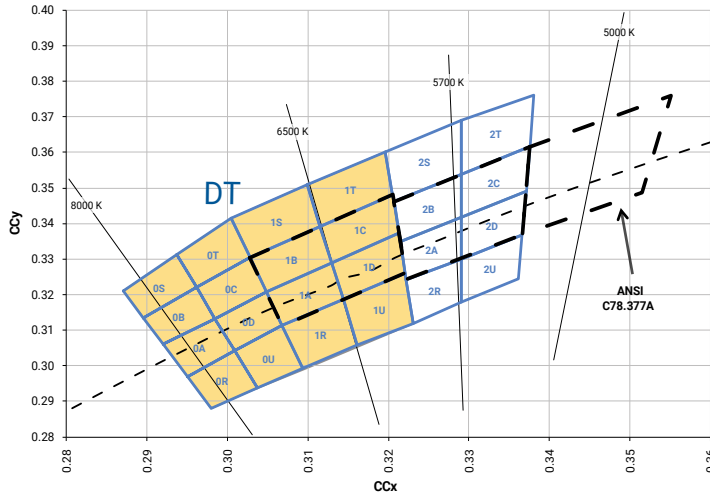

STANDARD WARM AND NEUTRAL WHITE KITS PLOTTED ON ANSI STANDARD CHROMATICITY REGIONS

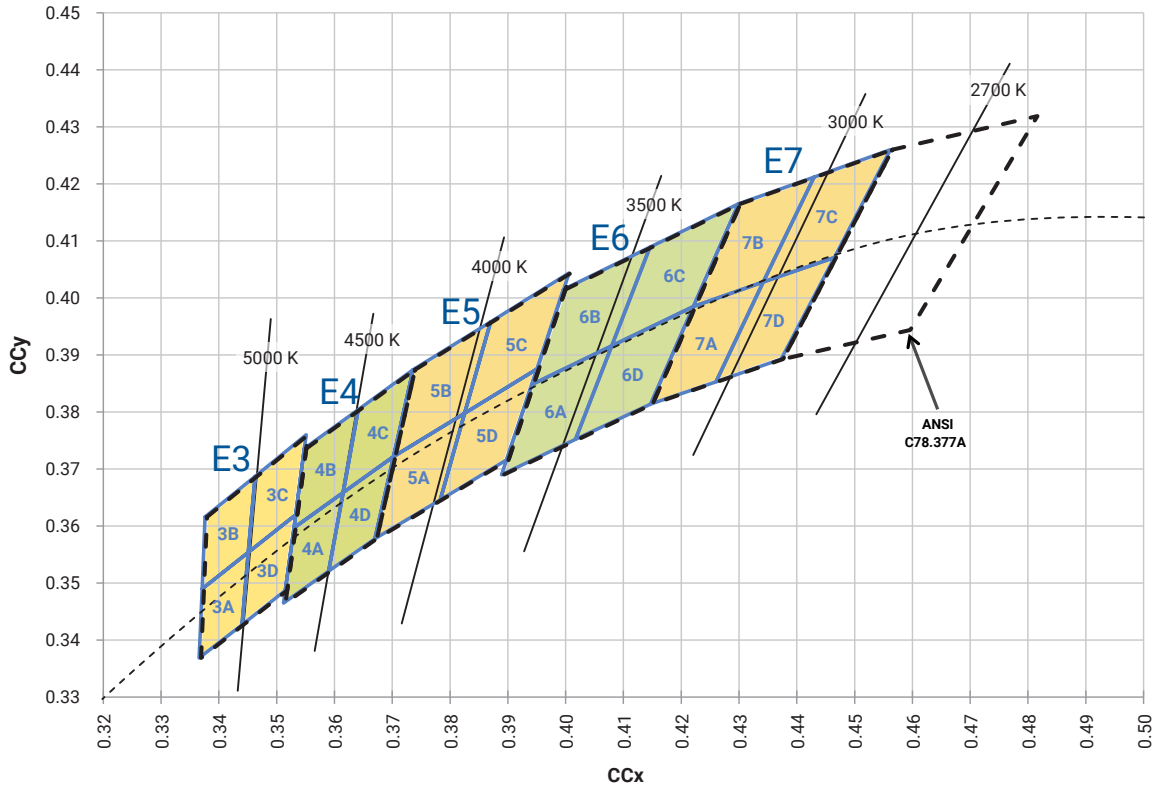

BIN AND ORDER-CODE FORMAT

Bin codes and order codes for XHP70.3 LEDs are configured in the following manner:

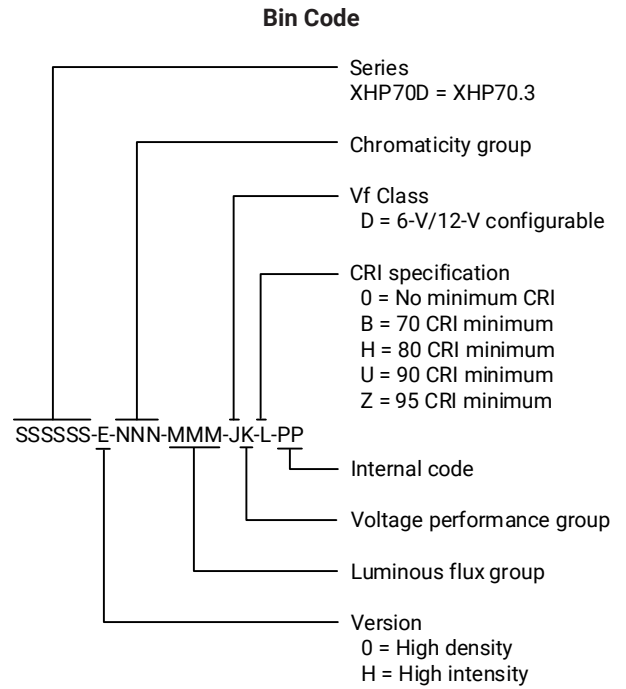
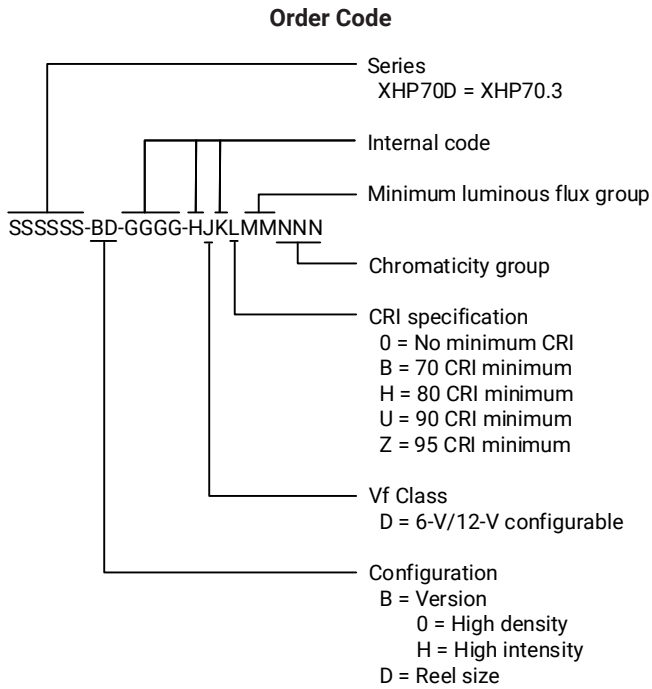

REFLOW SOLDERING CHARACTERISTICS

In testing, Cree LED has found XLamp XHP70.3 LEDs to be compatible with JEDEC J-STD-020C, using the parameters listed below. As a general guideline, Cree LED recommends that users follow the recommended soldering profile provided by the manufacturer of the solder paste used, and therefore it is the lamp or luminaire manufacturer’s responsibility to determine applicable soldering requirements.

Note that this general guideline may not apply to all PCB designs and configurations of reflow soldering equipment.

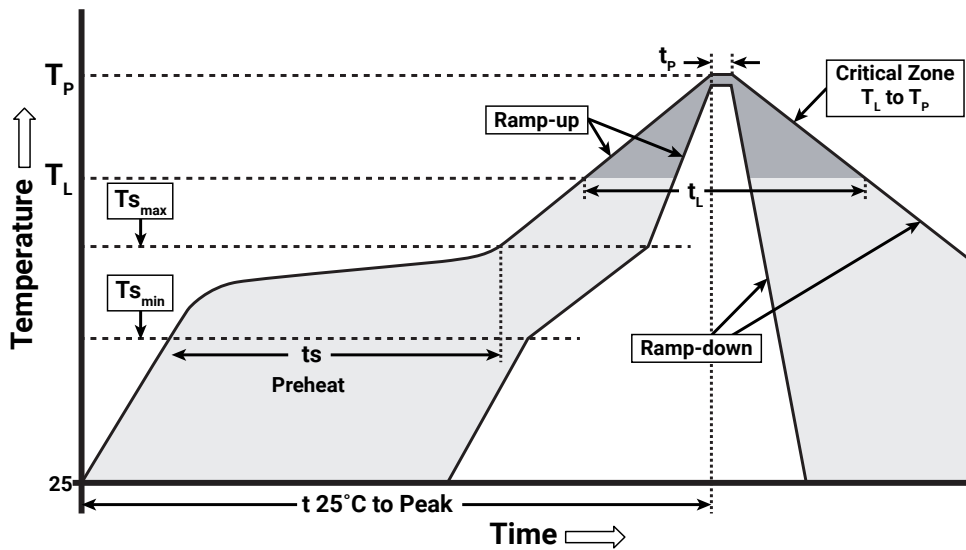

IPC/JEDEC J-STD-020C

Profile Feature	Lead-Free Solder
Average Ramp-Up Rate ($T_{s_{max}}$ to T_p)	1.2 °C/second
Preheat: Temperature Min ($T_{s_{min}}$)	120 °C
Preheat: Temperature Max ($T_{s_{max}}$)	170 °C
Preheat: Time ($t_{s_{min}}$ to $t_{s_{max}}$)	65-150 seconds
Time Maintained Above: Temperature (T_L)	217 °C
Time Maintained Above: Time (t_L)	45-90 seconds
Peak/Classification Temperature (T_p)	235 - 245 °C
Time Within 5 °C of Actual Peak Temperature (t_p)	20-40 seconds
Ramp-Down Rate	1 - 6 °C/second
Time 25 °C to Peak Temperature	4 minutes max.

Note: All temperatures refer to the topside of the package, measured on the package body surface.

NOTES

Measurements

The luminous flux, radiant power, chromaticity, forward voltage and CRI measurements in this document are binning specifications only and solely represent product measurements as of the date of shipment. These measurements will change over time based on a number of factors that are not within Cree LED's control and are not intended or provided as operational specifications for the products. Calculated values are provided for informational purposes only and are not intended or provided as specifications.

Pre-Release Qualification Testing

Please read the [LED Reliability Overview](#) for details of the qualification process Cree LED applies to ensure long-term reliability for XLamp LEDs and details of Cree LED's pre-release qualification testing for XLamp LEDs. Cree LED did not perform Room Temperature Operating Life (RTOL) testing on the XHP70.3 LED.

Lumen Maintenance

Cree LED now uses standardized IES LM-80-08 and TM-21-11 methods for collecting long-term data and extrapolating LED lumen maintenance. For information on the specific LM-80 data sets available for this LED, refer to the public [LM-80 results document](#).

Please read the [Long-Term Lumen Maintenance application note](#) for more details on Cree LED's lumen maintenance testing and forecasting. Please read the [Thermal Management application note](#) for details on how thermal design, ambient temperature, and drive current affect the LED junction temperature.

Moisture Sensitivity

Cree LED recommends keeping XLamp LEDs in the provided, resealable moisture-barrier packaging (MBP) until immediately prior to soldering. Unopened MBPs that contain XLamp LEDs do not need special storage for moisture sensitivity.

Once the MBP is opened, XLamp XHP70.3 LEDs may be stored as MSL 1 per JEDEC J-STD-033, meaning they have unlimited floor life in conditions of ≤ 30 °C/85% relative humidity (RH). Regardless of the storage condition, Cree LED recommends sealing any unsoldered LEDs in the original MBP.

RoHS Compliance

The levels of RoHS restricted materials in this product are below the maximum concentration values (also referred to as the threshold limits) permitted for such substances, or are used in an exempted application, in accordance with EU Directive 2011/65/EC (RoHS2), as implemented January 2, 2013. RoHS Declarations for this product can be obtained from your Cree LED representative or from the [Product Ecology](#) section of the Cree LED website.

REACH Compliance

REACH substances of very high concern (SVHCs) information is available for this product. Since the European Chemical Agency (ECHA) has published notice of their intent to frequently revise the SVHC listing for the foreseeable future, please contact a Cree LED representative to insure you get the most up-to-date REACH SVHC Declaration. REACH banned substance information (REACH Article 67) is also available upon request.

NOTES - CONTINUED

UL® Recognized Component

This product meets the requirements to be considered a UL Recognized Component with Level 4 enclosure consideration. The LED package or a portion thereof has been investigated as a fire and electrical enclosure per ANSI/UL 8750.

Vision Advisory

WARNING: Do not look at an exposed lamp in operation. Eye injury can result. For more information about LEDs and eye safety, please refer to the [LED Eye Safety application note](#).

MECHANICAL DIMENSIONS

Thermal vias, if present, are not shown on these drawings.

All dimensions are ± 0.13 mm unless otherwise indicated.

XHP70.3 High Density

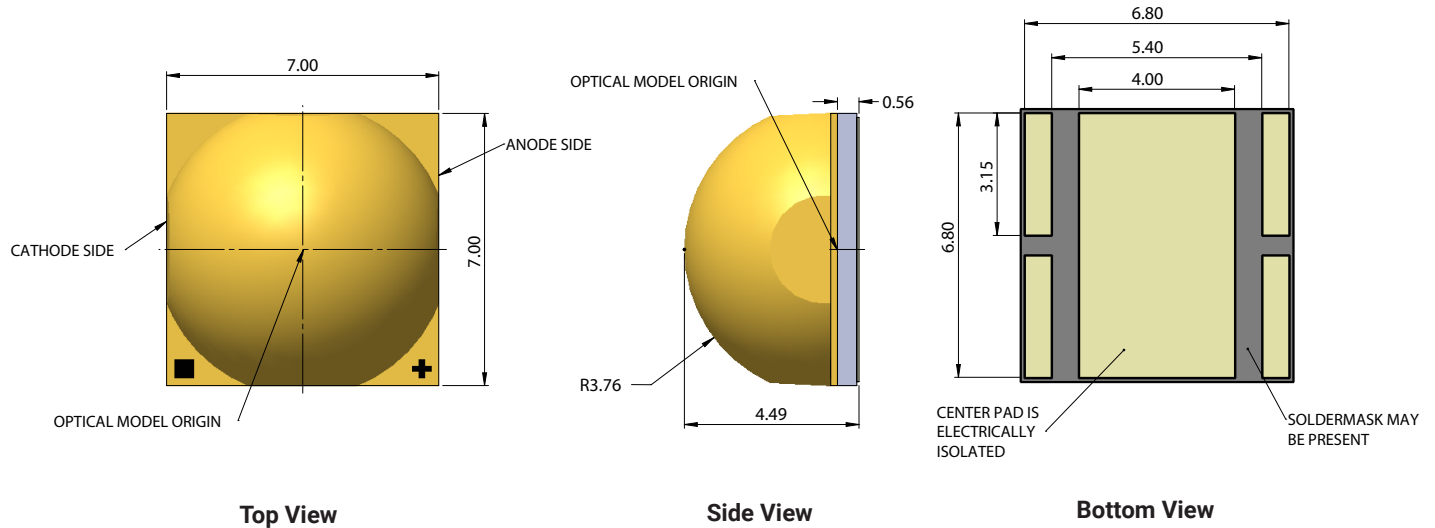

XHP70.3 High Intensity

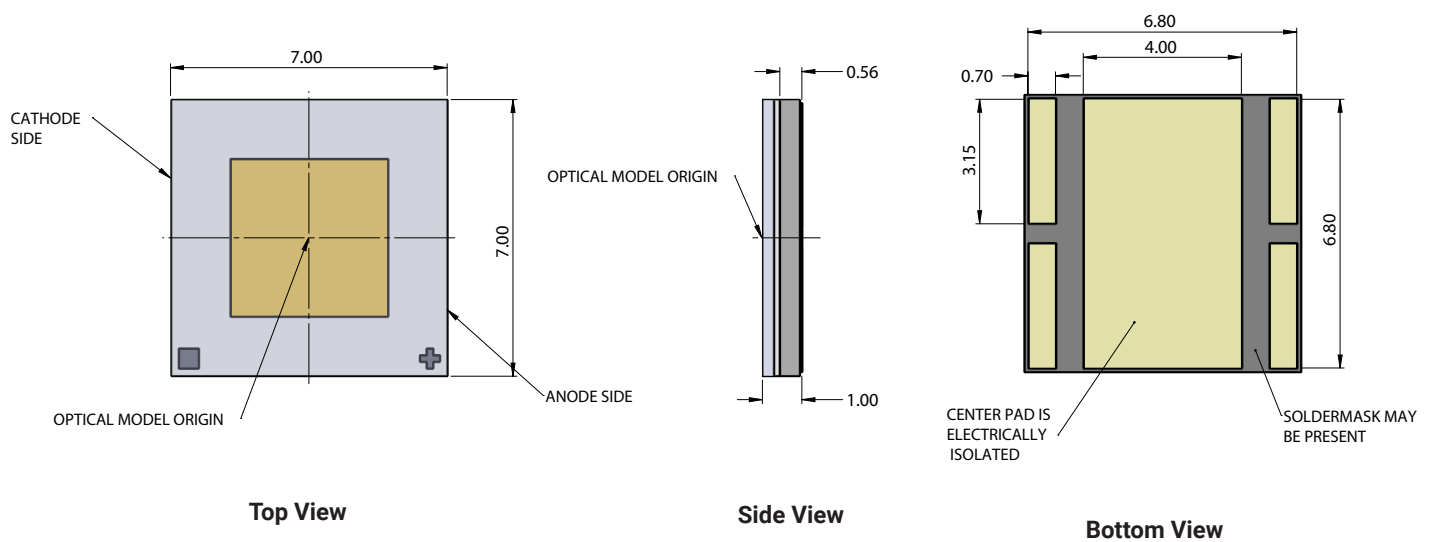

MECHANICAL DIMENSIONS - CONTINUED

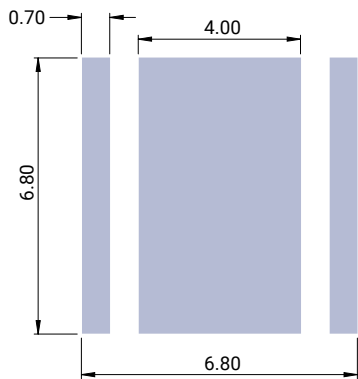

Recommended 6-V PCB Footprint
(center pad is electrically isolated)

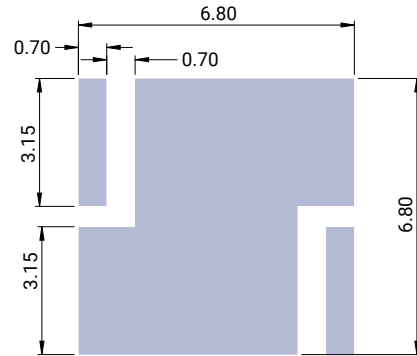

Recommended 12-V PCB Footprint
(center pad is connected to anode and cathode and is not electrically isolated)

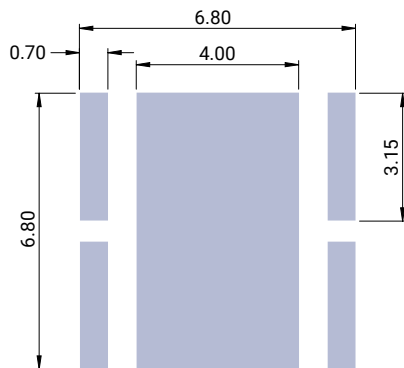

Recommended 6-V & 12-V PCB Solder Mask Opening
(solid area is open)

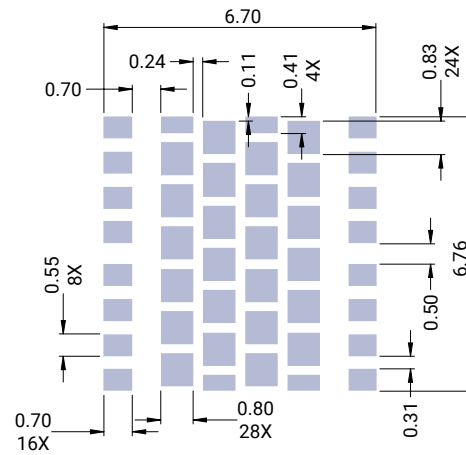

Recommended Stencil Openings
6 V & 12 V Configurations
(solid area is open)

ELECTRICAL CONFIGURATION

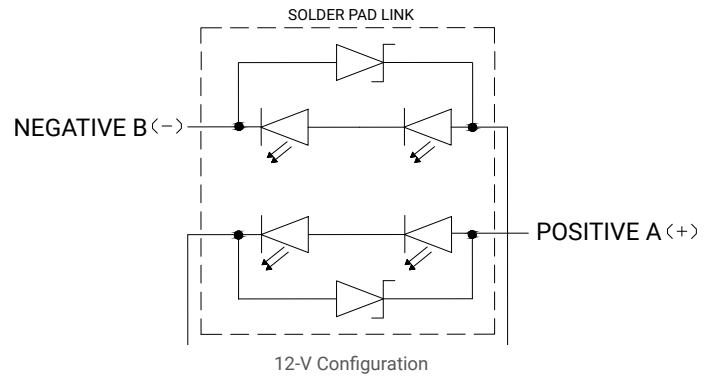
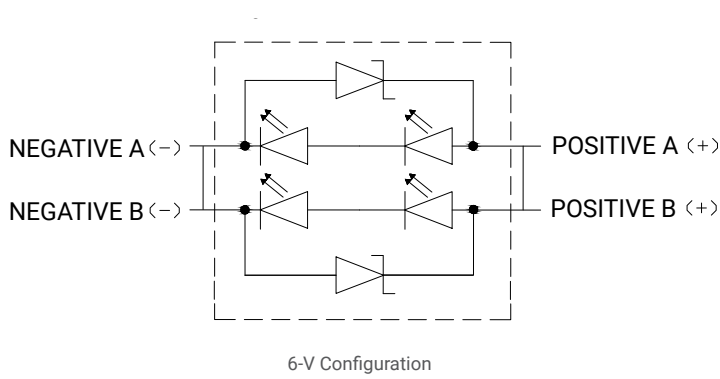

TAPE AND REEL

All Cree LED carrier tapes conform to EIA-481D, Automated Component Handling Systems Standard.

All dimensions are ± 0.13 mm unless otherwise indicated.

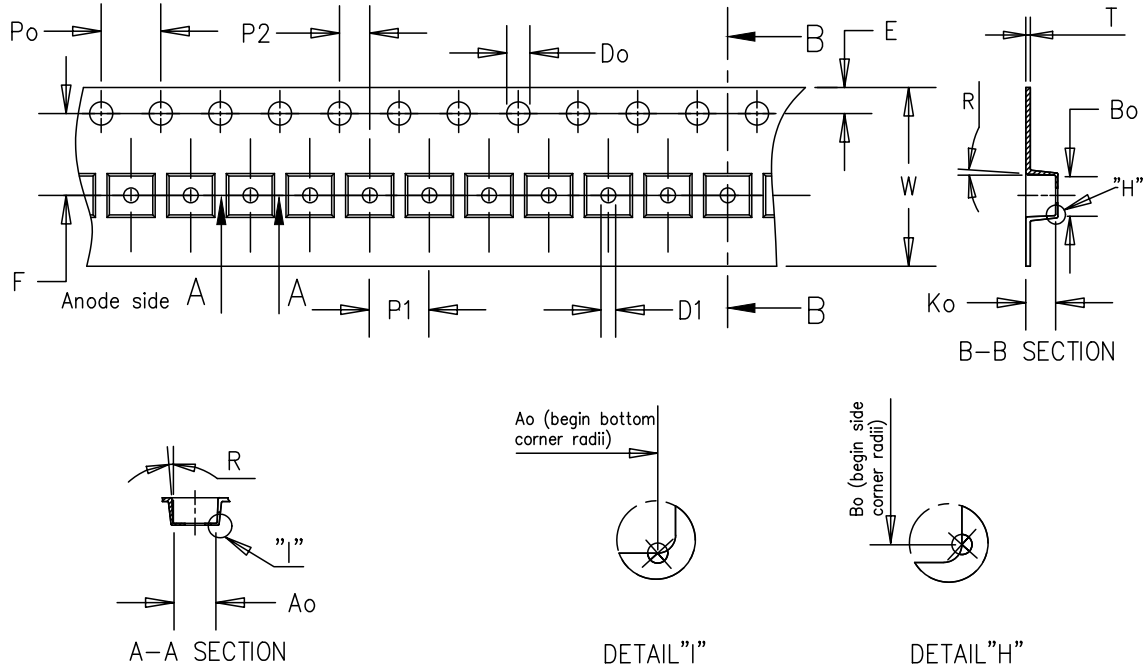

XHP70.3 High Density

Item	Ao	Bo	Ko	Po	P1	P2	T	E	F	Do	D1	W	R
Dim.	7.40	7.40	4.60	4.00	12.00	2.00	0.36	1.75	7.50	1.50	1.50	16.00	5°

XHP70.3 High Intensity

Item	Ao	Bo	Ko	Po	P1	P2	T	E	F	Do	D1	W	R
Dim.	7.60	7.60	1.70	4.00	12.00	2.00	0.30	1.75	7.50	1.50	1.50	16.00	3°

TAPE AND REEL - CONTINUED

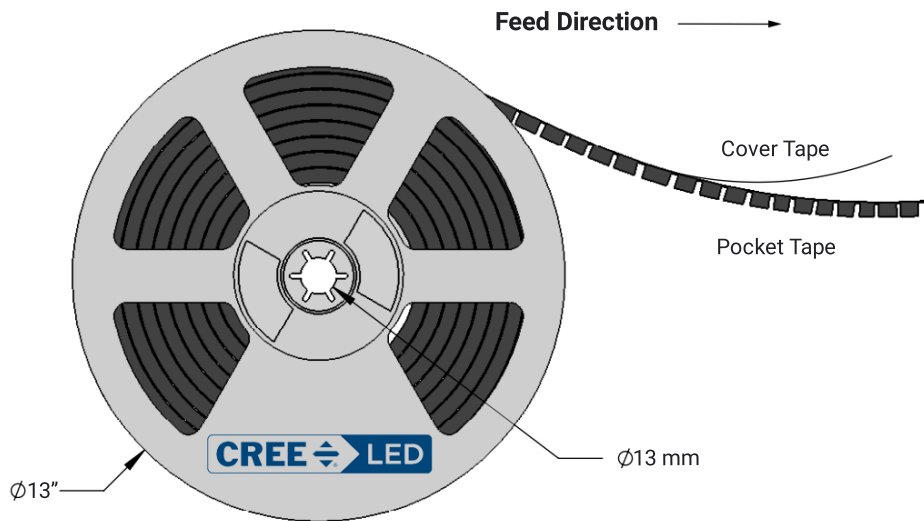
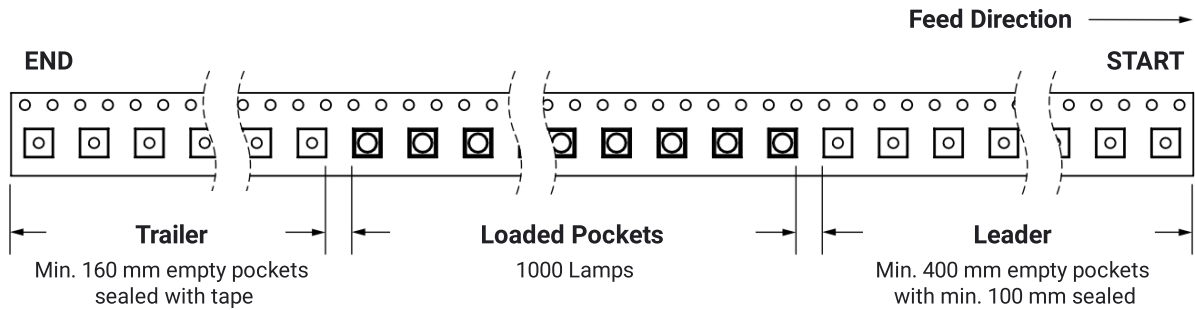

PACKAGING

Unpackaged Reel

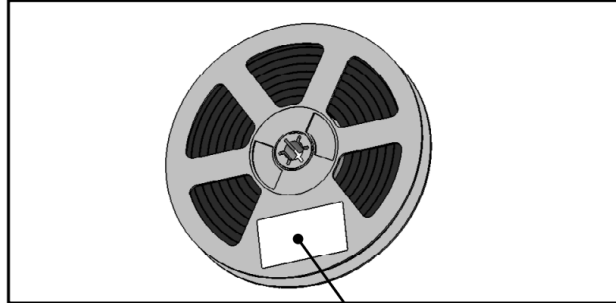

Label with Cree LED Bin Code, Quantity, Reel ID

Packaged Reel

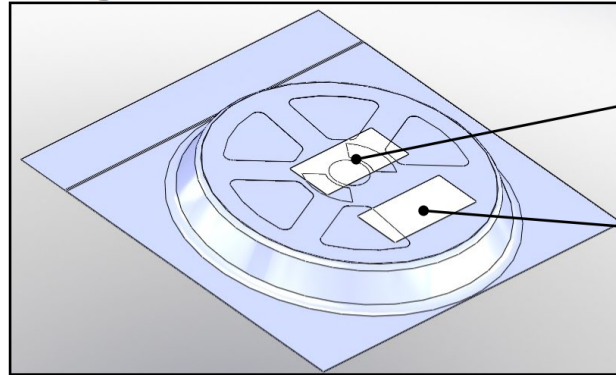

Label with Cree LED Order Code, Quantity, Reel ID, PO#

Label with Cree LED Bin Code, Quantity, Reel ID

Boxed Reel

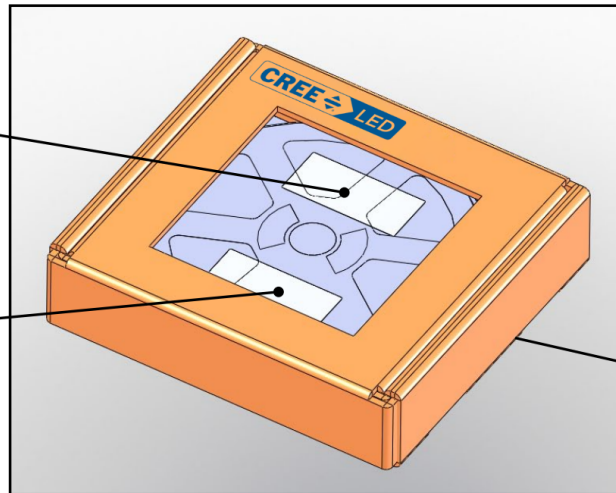

Label with Cree LED Order Code, Quantity, Reel ID, PO#

Label with Cree LED Bin Code, Quantity, Reel ID

Patent Label (on bottom of box)