

SPECIFICATIONS:

MATERIALS:

INSULATOR: GLASS-FILLED NYLON THERMOPLASTIC, UL94 V-0
 PROCESS TEMP: 260°C
 CONTACTS: GOLD PLATED BRASS
 SHELL: NICKEL PLATED STEEL

ELECTRICAL:

RATED CURRENT: 5A
 WORKING VOLTAGE: 250VAC
 INSULATION RESISTANCE: 1000 MOhms MIN.
 CONTACT RESISTANCE: 15 mOhms MAX.

ENVIRONMENT:

OPERATING TEMPERATURE: -55°C TO +125°C

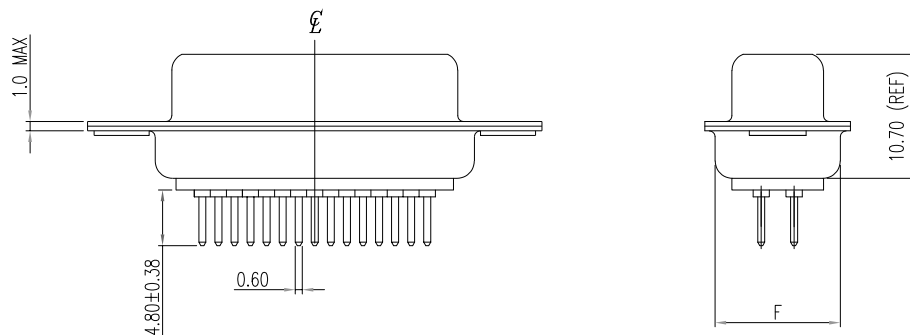
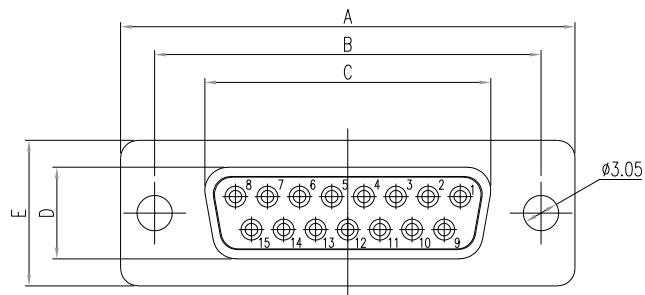

DIMENSIONS(mm)						
SIZE	A ^{+0.39} _{-0.39}	B ^{+0.25} _{-0.25}	C ^{+0.25} _{-0.25}	D ^{+0.25} _{-0.34}	E ^{+0.38} _{-0.38}	F ^{+0.25} _{-0.25}
9	30.81	24.99	16.33	7.90	12.55	10.80
15	39.19	33.32	24.66	7.90	12.55	10.80
25	53.04	47.04	38.38	7.90	12.55	10.80
37	69.32	63.50	54.84	7.90	12.55	10.80
50	67.00	61.10	52.20	10.90	15.40	13.30

172-EYY-21YRYY1

- SERIES _____
- POSITIONS _____
- 09 _____
- 15 _____
- 25 _____
- 37 _____
- 50 _____
- GENDER _____
- 2 = FEMALE
- TERMINATION _____
- 1 = DIP SOLDER
- SHELL PLATING _____
- 2 = TIN
- 3 = NICKEL
- HARDWARE OPTIONS _____
- 00 = NO HARDWARE
- 01 = .098" CLINCH NUT (BOARD SIDE)
- 02 = .236" CLINCH NUT (BOARD SIDE)
- 03 = .236" CLINCH NUT (MOUNTING SIDE)
- 05 = .237" 4-40 BOARD LOCK
- 08 = .228" 4-40 BOARD LOCK
- 90 = .237" 4-40 BOARD LOCK (FOR 0.093" BOARD MAX.)
- 91 = .237" 4-40 SPACER/ BOARD LOCK
- 92 = .237" 4-40 SPACER/ BOARD LOCK (FOR 0.093" BOARD MAX.)
- PLATING OPTIONS _____
- 1 = GOLD FLASH
- 2 = 30 MICRO-INCH GOLD
- 3 = 50 MICRO-INCH GOLD
- 5 = 15 MICRO-INCH GOLD

RoHS COMPLIANT

UNITS = mm

DO NOT SCALE FROM DRAWING



THESE DRAWINGS AND SPECIFICATIONS ARE THE PROPERTY OF NorComp AND SHALL NOT BE REPRODUCED, COPIED OR USED AS THE BASIS FOR THE MANUFACTURE OR SALE OF APPARATUS WITHOUT WRITTEN PERMISSION.

DRAWN:
P. JENKINS

DATE:
11/28/2005

NorComp

SCALE:
NTS

SHEET OF
1 3

REV
22

DWG NO.

172-EYY-21YRYY1

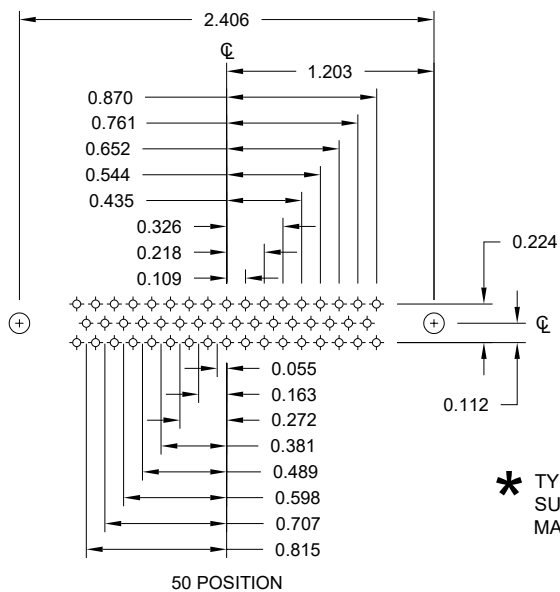
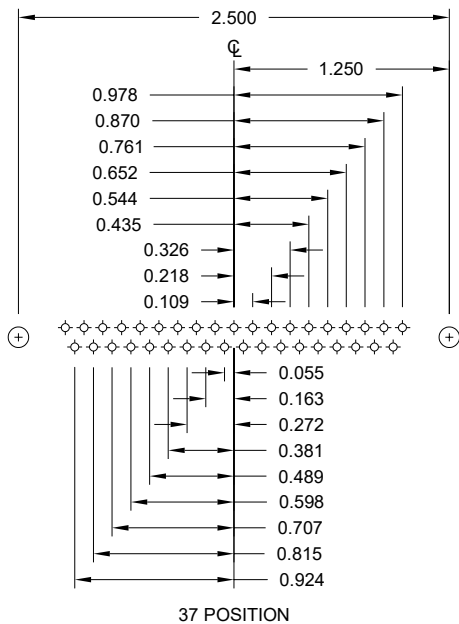
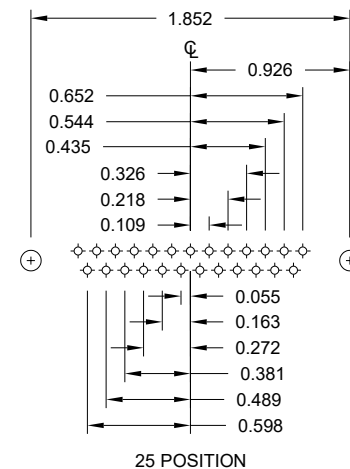
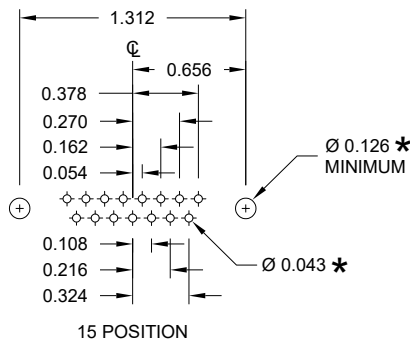
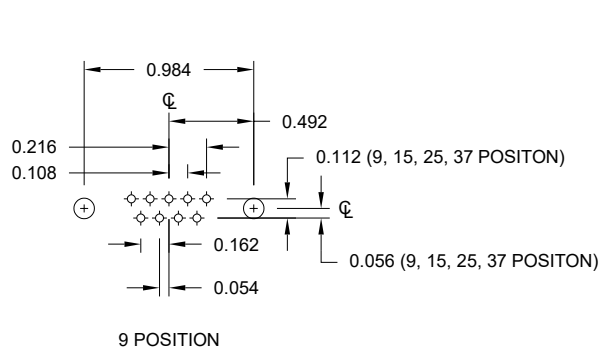

* TYP.
SUGGESTED SIZE
MAY NOT BE SUITABLE FOR ALL APPLICATIONS

RoHS COMPLIANT

UNITS = inch

DO NOT SCALE FROM DRAWING



THESE DRAWINGS AND SPECIFICATIONS ARE THE PROPERTY OF NorComp AND SHALL NOT BE REPRODUCED, COPIED OR USED AS THE BASIS FOR THE MANUFACTURE OR SALE OF APPARATUS WITHOUT WRITTEN PERMISSION.

DRAWN:
P. JENKINS

DATE:
11/28/2005

NorComp

SCALE:
NTS

SHEET OF
2 3

REV
22

DWG NO.

172-EYY-21YRY1

ALL CLINCH-NUTS ARE 4-40 INTERNAL THREADS

01 0.098" (BOARD SIDE)

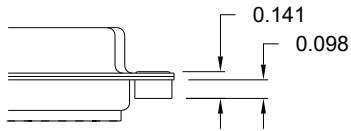

02 0.236" (BOARD SIDE)

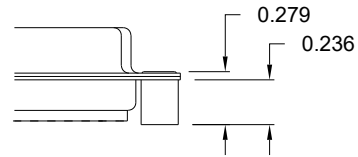

03 0.236" (MATING SIDE)

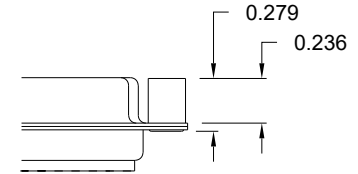

05 0.237" (BOARD SIDE)

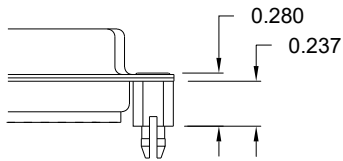

08 0.228" (BOARD SIDE)

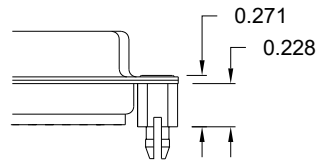

91 0.237" BOARD SIDE

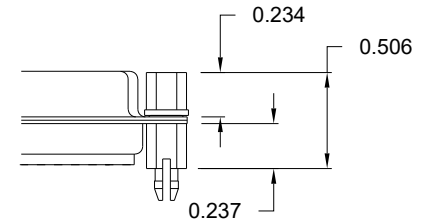

90 0.237" (BOARD SIDE)

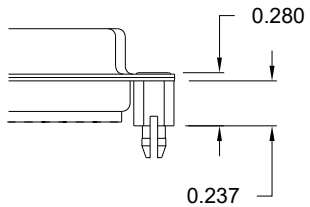

92 0.237" BOARD SIDE

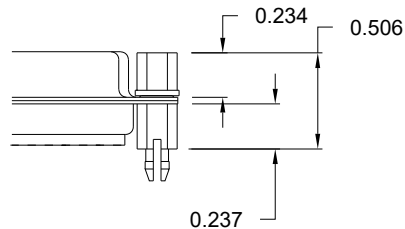

NOTE 1: 4-40 FEMALE SCREW LOCKS ARE REMOVABLE
 NOTE 2: 90 & 92 OPTIONS DESIGNED FOR 0.093" PCB THICKNESS
 NOTE 3: 05, 08, & 91 OPTIONS DESIGNED FOR 0.063" PCB THICKNESS

TOLERANCE:
 ALL DIMENSIONS ARE ±0.010

RoHS COMPLIANT

UNITS = inch

DO NOT SCALE FROM DRAWING



THESE DRAWINGS AND SPECIFICATIONS ARE THE PROPERTY OF NorComp AND SHALL NOT BE REPRODUCED, COPIED OR USED AS THE BASIS FOR THE MANUFACTURE OR SALE OF APPARATUS WITHOUT WRITTEN PERMISSION.

DRAWN:
 P. JENKINS

DATE:
 11/28/2005

NorComp

SCALE: NTS	SHEET 3	OF 3	REV 22
---------------	------------	---------	-----------

DWG NO. 172-EYY-21YRY1