



TILT – 33A

Dual-Axis Inclinator

Three-Axis Accelerometer



CTi SENSOR, INC.

Document Revision 1.2

CTi SENSORS TECHNICAL DOCUMENT

This is our product specific technical datasheet. The following information is available to assist CTi Sensors customers in product development.

TECHNICAL SUPPORT CONTACT INFO

Website: <http://ctisensors.com/contact-us/>

Email: info@ctisensors.com

Phone: (440) 264-2370

TABLE OF CONTENTS

1. INTRODUCTION	4
1.1 FEATURES	4
1.2 APPLICATIONS.....	4
2. SPECIFICATIONS	5
2.1. ANGLES	5
2.2. ACCELEROMETER.....	5
2.3. SYSTEM	5
2.4. MECHANICAL.....	6
3. TERMINAL ASSIGNMENT.....	6
4. WINCTI-TILT SOFTWARE.....	7
5. SERIAL INTERFACE AND DATA FORMAT.....	8
6. 8-BIT CHECKSUM.....	8
7. CONFIGURATION COMMANDS	9
8. DIMENSIONAL DRAWING.....	11
9. HORIZONTAL INSTALLATION POSITION	12
10. VERTICAL INSTALLATION POSITION	12
11. PART NUMBER	13
12. WIRED CABLES.....	14
13. REVISION HISTORY	15

1. Introduction

The TILT-33A series inclinometer or tilt sensor is a high performance, high resolution single or dual axis digital inclinometer (or inclination sensor) that uses the latest miniature technology in the form of accelerometer MEMS sensors. It is contained within a robust aluminum housing and has several interface options such as UART/USB, RS232, Wireless, RS485, and RS422. The TILT-33A series is an ideal solution for variety of high-performance industrial applications such as Robotic Systems, Automotive Safety Systems, and Platform Control & Alignment.

1.1 Features

- Dual mode digital inclinometer
 - Dual-axis, horizontal installation: $\pm 90^\circ$
 - Single-axis, vertical installation: $\pm 180^\circ$
- High resolution: $< 0.005^\circ$ | 0.1 mg
- High accuracy: $\text{err.} \leq 0.04^\circ$ (typical)
- Ultra low noise: $\pm 0.0014^\circ/\sqrt{\text{Hz}}$
- Very low temperature offset drift: $\pm 0.002^\circ/\text{C}$ (typical)
- Selectable accelerometer range: $\pm 2 \text{ g}/\pm 4 \text{ g}/\pm 8 \text{ g}$
- Programmable bandwidth and response time
- Simple ASCII interface language
- IP 67 compliant connector, cable, and housing
- Robust aluminum housing
- Low power consumption: $< 30 \text{ mA}$ (@ 5 V)

1.2 Applications

- Platform control, alignment, and stabilization
- Inclination and rotational movement measurement
- Antenna and satellite dish tracking and control
- Vibration and condition monitoring
- Navigation and GPS compensation
- Robotic position sensing and control
- Agricultural and industrial vehicle tilt monitoring

2. Specifications

2.1. Angles

Table 1. Angles

Parameter	Value
Range	Dual-axis (Hoz.): $\pm 90^\circ$, single-axis (Ver.): $\pm 180^\circ$
Accuracy: Horizontal Installation	Err. $\leq \pm 0.04^\circ$ (typical) $\pm 0.08^\circ$ maximum error in full range
Accuracy: Vertical Installation	Err. $< \pm 0.06^\circ$ (within $\pm 30^\circ$ of vertical)
Angular resolution	$< 0.005^\circ$ 0.1mg (@data rate ≤ 5)
Zero offset error (pitch and roll)	$< \pm 0.02^\circ$ (@ 20°C)
Offset change versus temperature	$\pm 0.002^\circ/\text{C}$ (typical)
Noise density	$0.0014^\circ/\text{VHz}$

2.2. Accelerometer

Table 2. Accelerometer

Parameter	Value
Range	$\pm 2\text{ g}/\pm 4\text{ g}/\pm 8\text{ g}$ selectable
Zero offset error	$< \pm 0.5\text{ mg}$ (@ 20°C)
Nonlinearity	$\pm 0.1\%$ FS
Bias change versus temperature	$\pm 0.02\text{ mg}/\text{C}$ (typical)
Noise density	$25\ \mu\text{g}/\text{VHz}$ (@ 200Hz)
Resonant frequency	2.4 kHz

2.3. System

Table 3. System

Parameter	Value
Power source	4.1-38 VDC
Power consumption	$< 30\text{ mA}$ (@ 5 V)
Data format	ASCII Port settings: 1 start bit, 8 data bits, 1 stop bit, no parity
Baud rate	2.4kbps – 921.6kbps selectable default: 115.2kbps
Output data rate	1, 2, 5, 10, 20, 25, 40, 50, 100, 200, and 500 Hz selectable
GUI software	WinCTi-Tilt®
Serial interface options	RS232, RS422, RS485, UART/USB, Wireless, RS485 with multi-drop networking
LED indicators	Green: CPU heartbeat, flashing at 1 Hz Red: data transmission rate, flashing at current data rate
Temperature sensor resolution	0.2°C

2.4. Mechanical

Table 4. Mechanical

Parameter	Value
Protection	IP 67 (housing, connector and cable)
Dimension	1.65" x 2.15" x 1.00"
Material (cable is optional as a third-party product)	Enclosure: anodized aluminum Connector: brass/nickel Cable molded head: TPU Cable carrier: TPU or nylon Conductor insulation: PVC
Temperature range	-40°C to +85°C (-40°F to +185°F)
Connection ¹	Cable gland connector M8, 6-contact (female)

3. Terminal Assignment

Table 5. Terminal Assignment

Connector	Wireless	RS232/UART/USB ²	RS422	RS485	Wire Color
Pin 1	+Vin	+Vin	+Vin	+Vin	Brown
Pin 2	GND	GND	GND	GND	White
Pin 3	–	TX	TX+	D+	Blue
Pin 4	–	–	TX-	D-	Black
Pin 5	–	RX	RX+	D+	Gray
Pin 6	–	–	RX-	D-	Pink

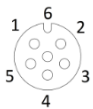

Device:
M 8 – 6-contact (female)

Cable:
M 8 – 6-pin (male)

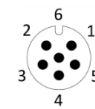

¹ Cable is a third-party product with temperature tolerance from -40°C to +105°C (-40°F to +221°F).

² USB uses UART interface and a UART to USB cable.

4. WinCTi-Tilt Software

WinCTi-Tilt is a graphical user interface (GUI) software provided by CTi Sensor Inc. for visualization aid, device configuration, and data logging. WinCTi-Tilt is designed to be intuitive to users. The package can be downloaded from the CTi Sensors website.

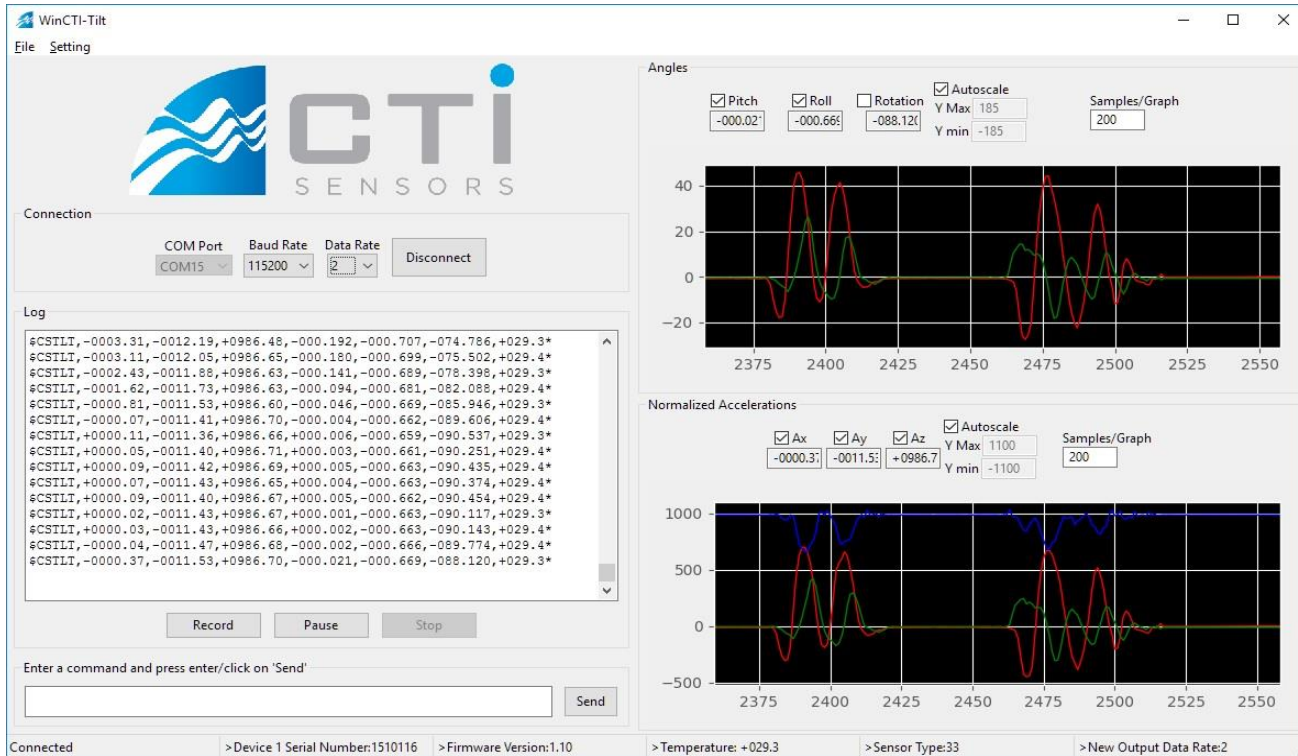

5. Serial Interface and Data Format

TILT-33A uses the following ASCII format, very similar to the widely used NMEA 0183 protocol, for data output:

- Default message: \$CSTLT, A_{XN}, A_{YN}, A_{ZN}, α_X, α_Y, R, T*CC<CR><LF>
- Optional message: \$CSACC, A_X, A_Y, A_Z, T*CC<CR><LF>

Which:

A_{XN}, A_{YN}, A_{ZN}: Normalized X, Y and Z accelerations in milli g

A_X, A_Y, A_Z: True X, Y and Z accelerations in milli g

α_X, α_Y: X and Y tilt or inclination angles in degrees, horizontal installation

R: Rotation angle in degrees, vertical installation

T: Internal temperature in degree centigrade

CC: Checksum (Two ASCII characters)

<CR> <LF>: Carriage return, and line feed characters

Example:

- \$CSTLT, +0011.24, -0032.10, +0991.07, +000.650, -001.854, -109.301, +027.7*70<CR><LF>
Data rate < 10
- \$CSTLT, +0011.2, -0032.1, +0991.4, +000.65, -001.85, -109.12, +027.7*72<CR><LF>
10 ≤ Data rate < 100
- \$CSTLT, +0011, -0032, +0991, +000.7, -001.8, -109.0, +028*4F<CR><LF>
Data rate ≥ 100

6. 8-bit Checksum

The checksum is calculated by XORing bitwise all bytes (each character is represented by 1 byte) between the \$ and * (not including the \$ or * characters) based on the NMEA standard. It results in two hexadecimal characters, which are sent in ASCII format.

The code for calculating and checking the checksum is as follows:

```
unsigned char cti_checksum(unsigned char * msg)
{
    unsigned int i;
    unsigned char crc = 0;
    for (i = 0; i < strlen((char *)msg); i++)
        crc ^= msg[i];
    return crc;
}
```

7. Configuration Commands

The TILT-33A uses a simple command format which allows the user to change the device configuration and request specific information or data. All commands start with a '[' character, and end with a carriage return character. All responses end with a carriage return and newline character. The table below shows the list of the interface commands for the TILT-33A series. In the table below, lowercase 'n' represents the unit number, which is set to 1 by default, and can be set by user to any number from 1 to 9.

Table 6. Interface Commands

Command	Comments	Response	Comments
[<u>n</u> <cr>	Ping unit number n	! <u>n</u> <cr><lf>	Acknowledge ping
[<u>N</u> ?<cr>	Request unit number	>Unit Number: <i>n</i>	Returns unit number, default: n=1
[<u>n</u> # <u>m</u> <cr>	Change unit number n to (non-zero) unit number m, $1 \leq m \leq 9$	>New Unit Number: <i>m</i>	n=old unit number, m=new unit number, default: n=1
[<u>n</u> #FW<cr>	Save unit number into flash memory	>Current Unit Number, <i>n</i> , was written into flash memory as the default Unit Number for this device!	Unit number will be changed permanently, and current unit number will be saved into the flash memory as the default unit number.
[<u>n</u> V<cr>	Firmware Version	>Firmware Version: <i>d.dd</i>	Returns firmware version
[<u>n</u> S<cr>	Serial Number	>Device <i>n</i> Serial Number: <i>ddddddd</i>	Returns 7-digit serial number
[<u>n</u> B <u>xxx</u> <cr>	Baud rate setting: xxx= 2:2400, 4:4800, 9:9600, 19:19200, 38:38400, 57:57600, 115:115200, 230:230400, 460:460800, 921:921600 (bps)	>Change to new Baud Rate: <i>dddddd</i>	Selected baud rate should support current data rate. Otherwise, baud rate will not be changed. Default baud rate is 115200 bps.
[<u>n</u> BFW<cr>	Save baud rate into flash memory	>Current Baud Rate, <i>dddddd</i> , was written into flash memory as the default Baud Rate!	Baud rate will be changed permanently, and current baud rate will be saved into the flash memory.
[<u>n</u> D <u>xxx</u> <cr>	Data rate setting: xxx = 1, 2, 5, 10, 20, 25, 40, 50, 100, 200, and 500 Hz	>New Output Data Rate: <i>ddd</i>	Default data rate is 2 Hz. New data rate will be saved into the flash memory.
[<u>n</u> AR <u>x</u> <cr>	Selecting accelerometer measurement range: x= ± 2 , ± 4 , ± 8 g	> New Accelerometer Range: <i>+/-d g</i>	New accelerometer range will be saved into the flash memory (Default: ± 2 g).
[<u>n</u> LPF <u>x</u> <cr>	Low-pass filter bandwidth setting: x=0 to 10. Projected bandwidth is 2^x Hz	> Low-pass Filter Bandwidth: <i>ddd Hz</i>	Set the bandwidth of low-pass filter for accelerometer data (default: x = 4, bandwidth = 16 Hz).
[<u>n</u> ZA<cr>	Zero g offset correction for X and Y axes	>Accelerometer Zero Offset Adjusted: X Offset: <i>ddd.d</i> , Y Offset: <i>ddd.d</i>	Current values of A_x and A_y will be saved into the flash memory as the zero g offset.
[<u>n</u> M <u>xy</u> <cr>	Output messages ON/OFF x= I: Inclinometer data A: Accelerometer data y=S: single message C: Continuous message X: Message Off	Data message will be sent out once, continuously or will be turned off	Example for inclinometer data: [1MIS: Sends out one data message [1MIC: Continuously sends out data message [1MIX: Stops sending out data message

Continued...

Command	Comments	Response	Comments
[<u>n</u> MICFW<cr>	Save output message ON/OFF status into flash memory	>Current ON/OFF message status was written into flash memory as the default status!	Current message ON/OFF status will be saved into flash memory.
[<u>n</u> RFD<cr>	Reset to factory default (Firmware version 1.16 and higher)	> Reset to factory default!	Resets the selectable parameters (except baud rate) to their default values.

8. Dimensional Drawing

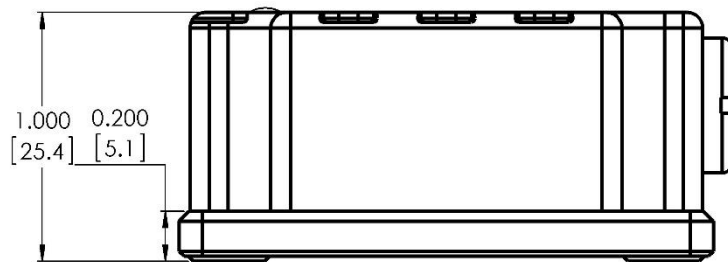
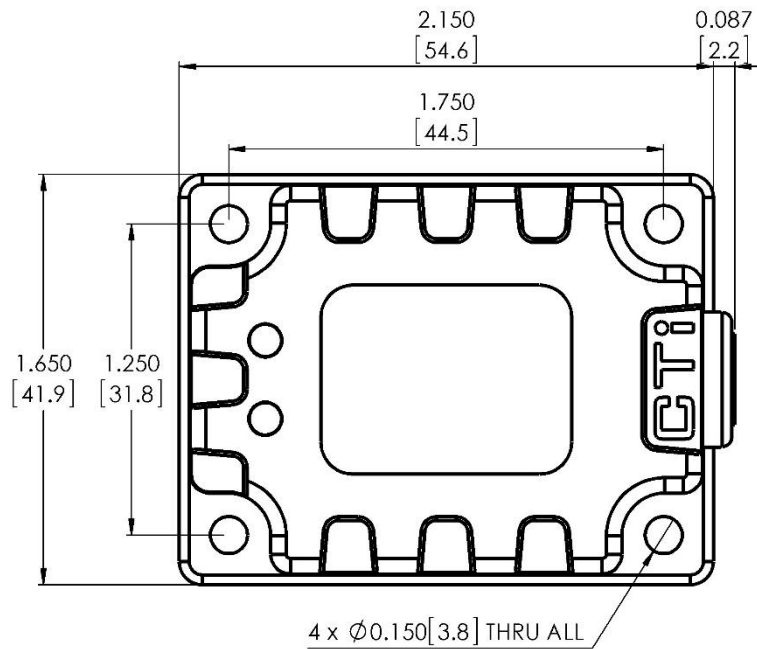

Inch
[millimeter]

9. Horizontal Installation Position

Measuring range: $\pm 90^\circ$ (two-dimensional)

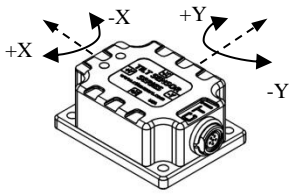

Default
Y=0

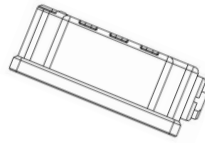

Inclination
Y=+30

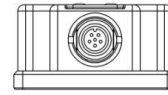

Default
X=0



Inclination
X=+30

10. Vertical Installation Position

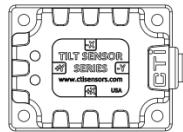
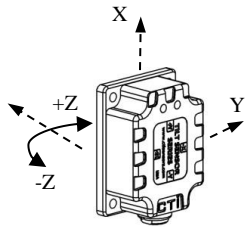

Rotation
R=0

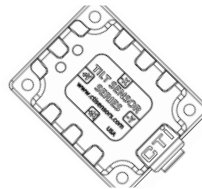

Rotation
R=+45

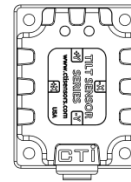

Rotation
R=90

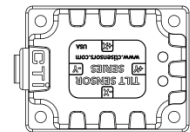

Rotation
R=+180

11. Part Number

TILT – 33A – 3 – A1

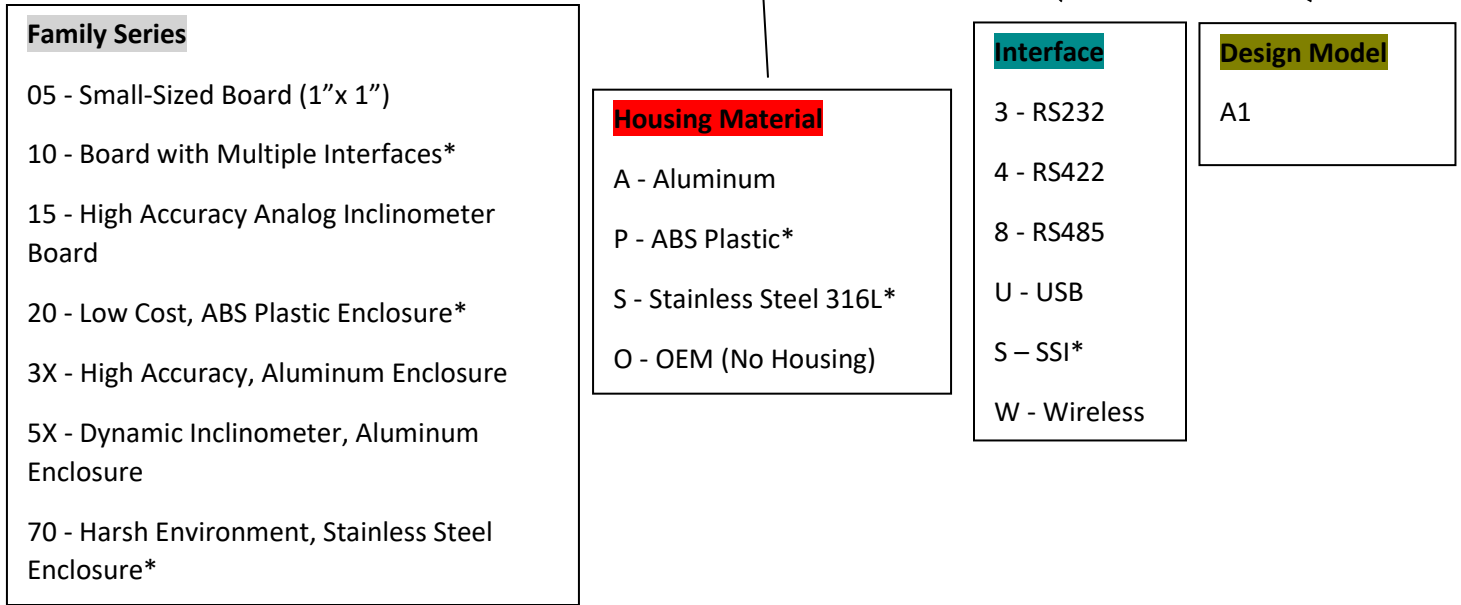

* These products are no longer available.

12. Wired Cables¹

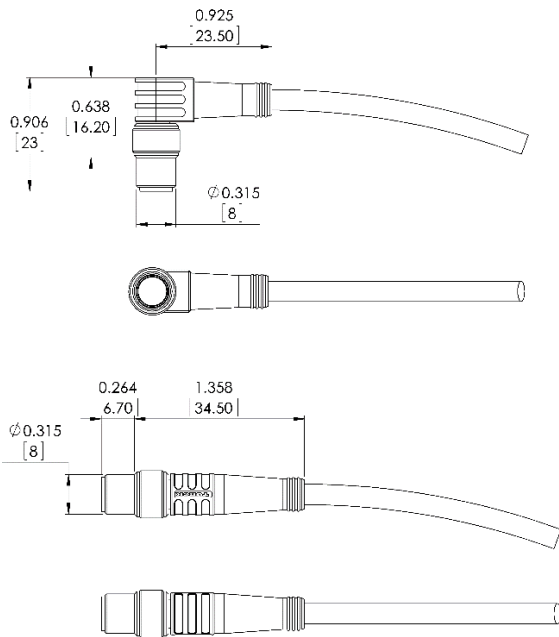
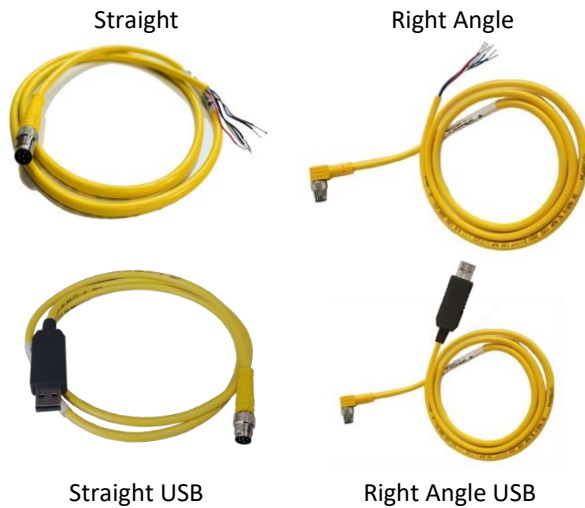

Inch
[millimeter]

Wireless Cables:

<https://ctisensors.com/Documents/Wireless-Datasheet.pdf>

Communication Cable Part Number ²

<u>XXX</u>	<u>XX</u>	-	<u>X</u>	-	<u>X</u>	-	<u>CS</u>
					Interface		
					<u>G</u>	<u>UART / RS232 / RS422 / RS485</u>	
					<u>U</u>	<u>USB</u>	
					<u>W</u>	<u>Wireless</u> ³	
					Length		
					<u>1</u>	<u>meter</u>	
					<u>2</u>	<u>meter</u>	
					<u>3</u>	<u>meter</u>	
					<u>4</u>	<u>meter (non-stock)</u>	
					<u>5</u>	<u>meter (non-stock)</u>	
					<u>6</u>	<u>meter (non-stock)</u>	
					<u>10</u>	<u>meter (Only PSG)</u>	
					<u>15</u>	<u>meter (non-stock)</u>	
					<u>30</u>	<u>meter (non-stock)</u>	
					Type		
					<u>PSG 6M</u>	<u>Straight</u>	
					<u>PSW 6M</u>	<u>Right Angle</u>	

Specifications

Protection	IP 67
Material	Connector: brass / nickel Cable molded head: TPU Cable carrier: TPU or nylon Conductor insulation: PVC
Operational Temperature range	-40°C to +85°C (-40°F to +185°F)
Connection	Cable gland Connector M8, 6-contact (male)

¹ Cable is a third party product.

² Available options for this model are underlined.

³ Wireless Module on device side has to be powered.

13.Revision History

Table 7. Revision History

Revision Number	Revision Date	Description of Changes
1.0	Oct. 2018	<ul style="list-style-type: none">Created document based on initial specifications
1.1	May. 2019	<ul style="list-style-type: none">Updated enclosure and specifications
1.2	Oct. 2022	<ul style="list-style-type: none">Updated information and formatting

WARRANTY: This product has 18 months limited warranty. For more information, please visit:
www.CTiSensors.com/warranty

This product is designed and manufactured in the U.S.A.

CTi Sensor, Inc.

30301 Emerald Valley Parkway, Unit B

Solon, OH 44139

Phone: (440) 264 - 2370

Email: Sales@CTiSensors.com

All contents of this document are subject to change without notice.