

## Optocoupler, Phototransistor Output (Dual, Quad Channel)

Dual Channel

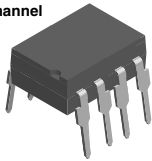

Quad Channel

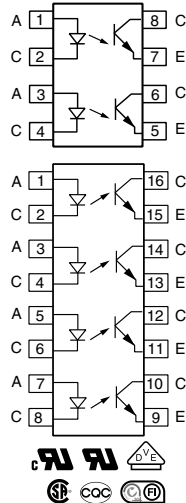
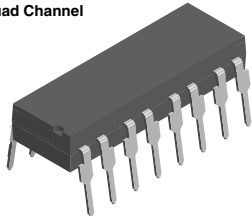

### FEATURES

- Alternate source to TLP621-2, TLP621-4 and TLP621GB-2, TLP621GB-4
- High collector emitter voltage,  $BV_{CEO} = 70\text{ V}$
- Dual and quad packages feature:
  - Lower pin and parts count
  - Better channel to channel CTR match
  - Improved common mode rejection
- Isolation rated voltage  $4420\text{ V}_{RMS}$
- Material categorization: for definitions of compliance please see [www.vishay.com/doc?99912](http://www.vishay.com/doc?99912)



RoHS COMPLIANT

### AGENCY APPROVALS

- [UL](#)
- [cUL](#)
- [DIN EN 60747-5-5 \(VDE 0884-5\)](#), available with option 1
- [CQC GB4943.1](#)
- [CQC GB8898](#)
- [FIMKO](#)

### LINKS TO ADDITIONAL RESOURCES



### DESCRIPTION

The ILD621, ILQ621, ILD621GB, ILQ621GB are multi-channel phototransistor optocouplers that use GaAs IRED emitters and high gain NPN silicon phototransistors. These devices are constructed using double molded insulation technology.

The ILD621, ILQ621GB is well suited for CMOS interfacing given the  $CTR_{CEsat}$  of 30 % minimum at  $I_F$  of 1.0 mA. High gain linear operation is guaranteed by a minimum  $CTR_{CE}$  of 100 % at 5.0 mA. The ILD621, ILQ621 has a guaranteed  $CTR_{CE}$  50 % minimum at 5.0 mA. The transparent ion shield insures stable DC gain in applications such as power supply feedback circuits, where constant DC  $V_{IO}$  voltages are present.

### ORDERING INFORMATION



x = D (Dual) or Q (Quad)

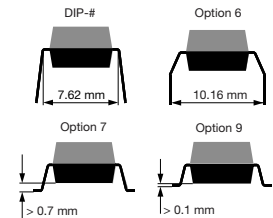

AGENCY CERTIFIED / PACKAGE	DUAL CHANNEL		QUAD CHANNEL	
	CTR (%)			
<b>UL, cUL, CSA, CQC, FIMKO</b>	<b>&gt; 50</b>	<b>&gt; 100</b>	<b>&gt; 50</b>	<b>&gt; 100</b>
DIP-8	-	ILD621GB	-	-
SMD-8, option 7	ILD621-X007T	ILD621GB-X007T	-	-
DIP-16	-	-	ILQ621	ILQ621GB
DIP-16, option 6	-	-	ILQ621-X006	-
SMD-16, option 7	-	-	ILQ621-X007T	-
SMD-16, option 9	-	-	-	ILQ621GB-X009
<b>VDE, UL, cUL, CSA, CQC, FIMKO</b>	<b>&gt; 50</b>	<b>&gt; 100</b>	<b>&gt; 50</b>	<b>&gt; 100</b>
DIP-16	-	-	-	ILQ621GB-X001
SMD-16, option 7	-	-	-	ILQ621GB-X017T

### Note

- For additional information on the available options refer to option information



ABSOLUTE MAXIMUM RATINGS (T <sub>amb</sub> = 25 °C, unless otherwise specified)					
PARAMETER	TEST CONDITION	PART	SYMBOL	VALUE	UNIT
<b>INPUT</b>					
Reverse voltage			V <sub>R</sub>	6.0	V
Forward current			I <sub>F</sub>	60	mA
Surge current			I <sub>FSM</sub>	1.5	A
Power dissipation			P <sub>diss</sub>	100	mW
Derate from 25 °C				1.33	mW/°C
<b>OUTPUT</b>					
Collector emitter reverse voltage			V <sub>CEO</sub>	70	V
Collector current			I <sub>C</sub>	50	mA
	t < 1.0 ms		I <sub>C</sub>	100	mA
Power dissipation			P <sub>diss</sub>	150	mW
Derate from 25 °C				-2.0	mW/°C
<b>COUPLER</b>					
Package dissipation		ILD621		400	mW
		ILD621GB		400	mW
Derate from 25 °C				5.33	mW/°C
Package dissipation		ILQ621		500	mW
		ILQ621GB		500	mW
Derate from 25 °C				6.67	mW/°C
Storage temperature			T <sub>stg</sub>	-55 to +150	°C
Operating temperature			T <sub>amb</sub>	-55 to +100	°C
Junction temperature			T <sub>j</sub>	100	°C
Soldering temperature <sup>(1)</sup>	2.0 mm from case bottom		T <sub>slid</sub>	260	°C

**Notes**

- Stresses in excess of the absolute maximum ratings can cause permanent damage to the device. Functional operation of the device is not implied at these or any other conditions in excess of those given in the operational sections of this document. Exposure to absolute maximum ratings for extended periods of the time can adversely affect reliability.
- <sup>(1)</sup> Refer to reflow profile for soldering conditions for surface mounted devices (SMD). Refer to wave profile for soldering conditions for through hole devices (DIP).

ELECTRICAL CHARACTERISTICS (T <sub>amb</sub> = 25 °C, unless otherwise specified)							
PARAMETER	TEST CONDITION	PART	SYMBOL	MIN.	TYP.	MAX.	UNIT
<b>INPUT</b>							
Forward voltage	I <sub>F</sub> = 10 mA		V <sub>F</sub>	1.0	1.15	1.3	V
Reverse current	V <sub>R</sub> = 6.0 V		I <sub>R</sub>	-	0.01	10	μA
Capacitance	V <sub>R</sub> = 0 V, f = 1.0 MHz		C <sub>O</sub>	-	40	-	pF
Thermal resistance, junction to lead			R <sub>THJL</sub>	-	750	-	K/W
<b>OUTPUT</b>							
Collector emitter capacitance	V <sub>CE</sub> = 5.0 V, f = 1.0 MHz		C <sub>CE</sub>	-	6.8	-	pF
Collector emitter leakage current	V <sub>CE</sub> = 24 V		I <sub>CEO</sub>	-	10	100	nA
			I <sub>CEO</sub>	-	20	50	μA
Thermal resistance, junction to lead			R <sub>THJL</sub>	-	500	-	K/W
<b>COUPLER</b>							
Capacitance (input to output)	V <sub>IO</sub> = 0 V, f = 1.0 MHz		C <sub>IO</sub>	0.8	-	-	pF
Insulation resistance	V <sub>IO</sub> = 500 V			10 <sup>12</sup>	-	-	Ω
Channel to channel insulation				500	-	-	VAC
Collector emitter saturation voltage	I <sub>F</sub> = 8.0 mA, I <sub>CE</sub> = 2.4 mA	ILD621	V <sub>CEsat</sub>	-	-	0.4	V
		ILQ621					
	I <sub>F</sub> = 1.0 mA, I <sub>CE</sub> = 0.2 mA	ILD621GB	V <sub>CEsat</sub>	-	-	0.4	V
		ILQ621GB					

**Note**

- Minimum and maximum values are testing requirements. Typical values are characteristics of the device and are the result of engineering evaluation. Typical values are for information only and are not part of the testing requirements.



CURRENT TRANSFER RATIO							
PARAMETER	TEST CONDITION	PART	SYMBOL	MIN.	TYP.	MAX.	UNIT
Channel/channel CTR match	$I_F = 5.0 \text{ mA}$ , $V_{CE} = 5.0 \text{ V}$		CTR <sub>X</sub> /CTR <sub>Y</sub>	1 to 1	-	3 to 1	%
Current transfer ratio (collector emitter saturated)	$I_F = 1.0 \text{ mA}$ , $V_{CE} = 0.4 \text{ V}$	ILD621	CTR <sub>CEsat</sub>	-	60	-	%
		ILQ621	CTR <sub>CEsat</sub>	-	60	-	%
		ILD621GB	CTR <sub>CEsat</sub>	30	-	-	%
		ILQ621GB	CTR <sub>CEsat</sub>	30	-	-	%
Current transfer ratio (collector emitter)	$I_F = 5.0 \text{ mA}$ , $V_{CE} = 5.0 \text{ V}$	ILD621	CTR <sub>CE</sub>	50	80	600	%
		ILQ621	CTR <sub>CE</sub>	50	80	600	%
		ILD621GB	CTR <sub>CE</sub>	100	200	600	%
		ILQ621GB	CTR <sub>CE</sub>	100	200	600	%

SWITCHING CHARACTERISTICS							
PARAMETER	TEST CONDITION	SYMBOL	MIN.	TYP.	MAX.	UNIT	
<b>NON-SATURATED</b>							
On time	$I_F = 10 \text{ mA}$ , $V_{CC} = 5.0 \text{ V}$ , $R_L = 75 \Omega$ , 50 % of $V_{PP}$	$t_{on}$	-	3.0	-	$\mu\text{s}$	
Rise time	$I_F = 10 \text{ mA}$ , $V_{CC} = 5.0 \text{ V}$ , $R_L = 75 \Omega$ , 50 % of $V_{PP}$	$t_r$	-	2.0	-	$\mu\text{s}$	
Off time	$I_F = 10 \text{ mA}$ , $V_{CC} = 5.0 \text{ V}$ , $R_L = 75 \Omega$ , 50 % of $V_{PP}$	$t_{off}$	-	2.3	-	$\mu\text{s}$	
Fall time	$I_F = 10 \text{ mA}$ , $V_{CC} = 5.0 \text{ V}$ , $R_L = 75 \Omega$ , 50 % of $V_{PP}$	$t_f$	-	2.0	-	$\mu\text{s}$	
Propagation H to L	$I_F = 10 \text{ mA}$ , $V_{CC} = 5.0 \text{ V}$ , $R_L = 75 \Omega$ , 50 % of $V_{PP}$	$t_{PHL}$	-	1.1	-	$\mu\text{s}$	
Propagation L to H	$I_F = 10 \text{ mA}$ , $V_{CC} = 5.0 \text{ V}$ , $R_L = 75 \Omega$ , 50 % of $V_{PP}$	$t_{PLH}$	-	2.5	-	$\mu\text{s}$	
<b>SATURATED</b>							
On time	$I_F = 10 \text{ mA}$ , $V_{CC} = 5.0 \text{ V}$ , $R_L = 1 \text{ k}\Omega$ , $V_{TH} = 1.5 \text{ V}$	$t_{on}$	-	4.3	-	$\mu\text{s}$	
Rise time	$I_F = 10 \text{ mA}$ , $V_{CC} = 5.0 \text{ V}$ , $R_L = 1 \text{ k}\Omega$ , $V_{TH} = 1.5 \text{ V}$	$t_r$	-	2.8	-	$\mu\text{s}$	
Off time	$I_F = 10 \text{ mA}$ , $V_{CC} = 5.0 \text{ V}$ , $R_L = 1 \text{ k}\Omega$ , $V_{TH} = 1.5 \text{ V}$	$t_{off}$	-	2.5	-	$\mu\text{s}$	
Fall time	$I_F = 10 \text{ mA}$ , $V_{CC} = 5.0 \text{ V}$ , $R_L = 1 \text{ k}\Omega$ , $V_{TH} = 1.5 \text{ V}$	$t_f$	-	11	-	$\mu\text{s}$	
Propagation H to L	$I_F = 10 \text{ mA}$ , $V_{CC} = 5.0 \text{ V}$ , $R_L = 1 \text{ k}\Omega$ , $V_{TH} = 1.5 \text{ V}$	$t_{PHL}$	-	2.6	-	$\mu\text{s}$	
Propagation L to H	$I_F = 10 \text{ mA}$ , $V_{CC} = 5.0 \text{ V}$ , $R_L = 1 \text{ k}\Omega$ , $V_{TH} = 1.5 \text{ V}$	$t_{PLH}$	-	7.2	-	$\mu\text{s}$	

COMMON MODE TRANSIENT IMMUNITY							
PARAMETER	TEST CONDITION	SYMBOL	MIN.	TYP.	MAX.	UNIT	
Common mode rejection, output high	$V_{CM} = 50 V_{P-P}$ , $R_L = 1.0 \text{ k}\Omega$ , $I_F = 0 \text{ mA}$	CM <sub>H</sub>	-	5000	-	V/ $\mu\text{s}$	
Common mode rejection, output low	$V_{CM} = 50 V_{P-P}$ , $R_L = 1.0 \text{ k}\Omega$ , $I_F = 10 \text{ mA}$	CM <sub>L</sub>	-	5000	-	V/ $\mu\text{s}$	

SAFETY AND INSULATION RATINGS				
PARAMETER	TEST CONDITION	SYMBOL	VALUE	UNIT
Climatic classification	According to IEC 68 part 1		55 / 100 / 21	
Comparative tracking index		CTI	175	
Maximum rated withstanding isolation voltage	$t = 1 \text{ min}$	$V_{ISO}$	4420	$V_{RMS}$
Isolation test voltage	$t = 1.0 \text{ s}$	$V_{ISO}$	5300	$V_{RMS}$
Maximum transient isolation voltage		$V_{IOTM}$	10 000	$V_{peak}$
Maximum repetitive peak isolation voltage		$V_{IORM}$	890	$V_{peak}$
Isolation resistance	$V_{IO} = 500 \text{ V}$ , $T_{amb} = 25 \text{ }^\circ\text{C}$	$R_{IO}$	$\geq 10^{12}$	$\Omega$
	$V_{IO} = 500 \text{ V}$ , $T_{amb} = 100 \text{ }^\circ\text{C}$	$R_{IO}$	$\geq 10^{11}$	$\Omega$
Output safety power		$P_{SO}$	400	mW
Input safety current		$I_{SI}$	275	mA
Safety temperature		$T_s$	175	$^\circ\text{C}$
Creepage distance			$\geq 7$	mm
Clearance distance			$\geq 7$	mm
Insulation thickness		DTI	$\geq 0.4$	mm

**Note**

- As per IEC 60747-5-5, § 7.4.3.8.2, this optocoupler is suitable for "safe electrical insulation" only within the safety ratings. Compliance with the safety ratings shall be ensured by means of protective circuits.

**TYPICAL CHARACTERISTICS** ( $T_{amb} = 25\text{ }^{\circ}\text{C}$ , unless otherwise specified)

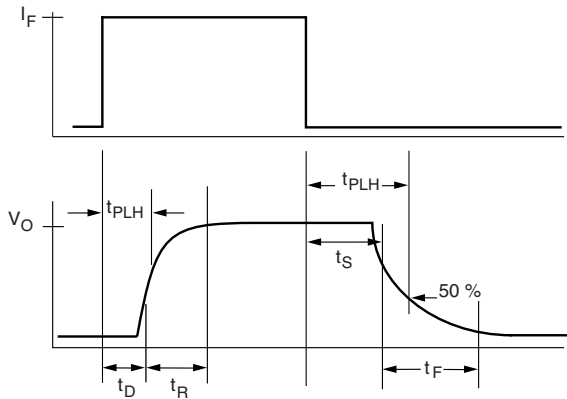

iiild621\_01

Fig. 1 - Non-Saturated Switching Timing

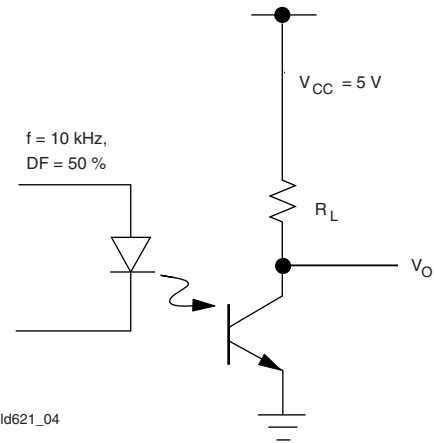

iiild621\_04

Fig. 4 - Saturated Switching Timing

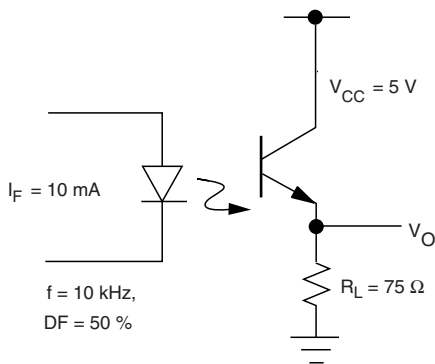

iiild621\_02

Fig. 2 - Non-Saturated Switching Timing

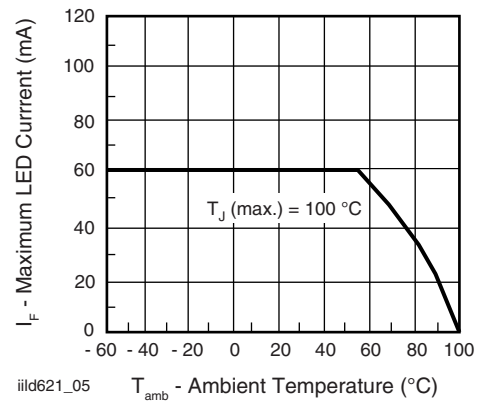

iiild621\_05

Fig. 5 - Maximum LED Current vs. Ambient Temperature

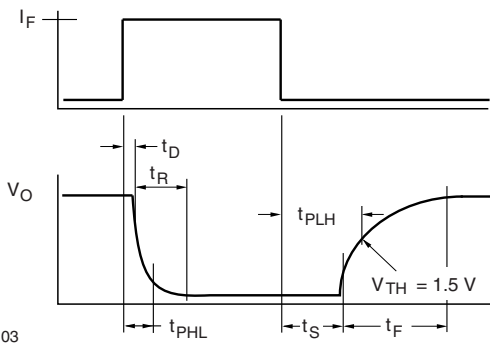

iiild621\_03

Fig. 3 - Saturated Switching Timing

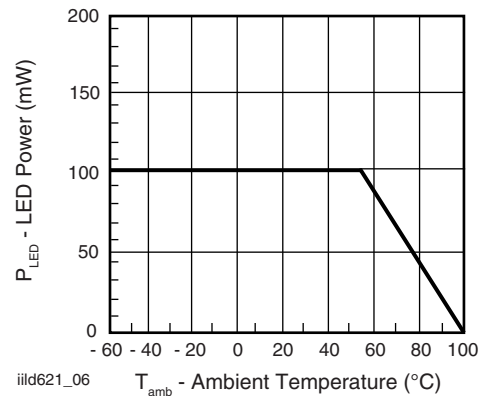

iiild621\_06

Fig. 6 - Maximum LED Power Dissipation

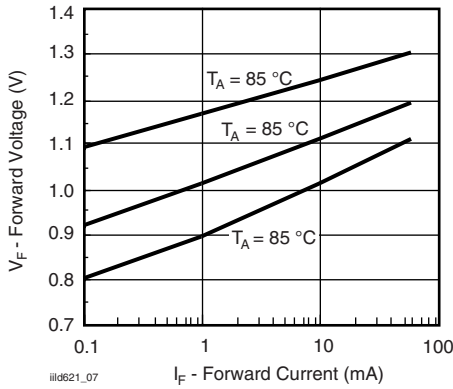

Fig. 7 - Forward Voltage vs. Forward Current

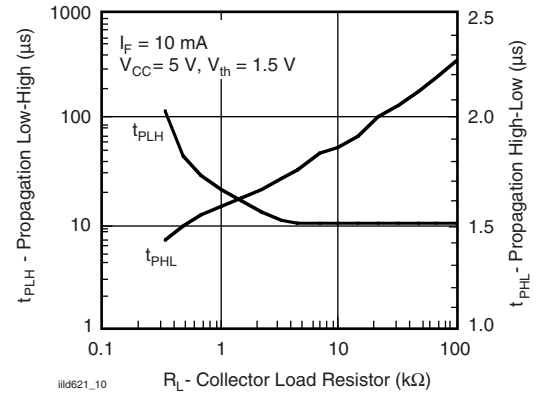

Fig. 10 - Propagation Delay vs. Collector Load Resistor

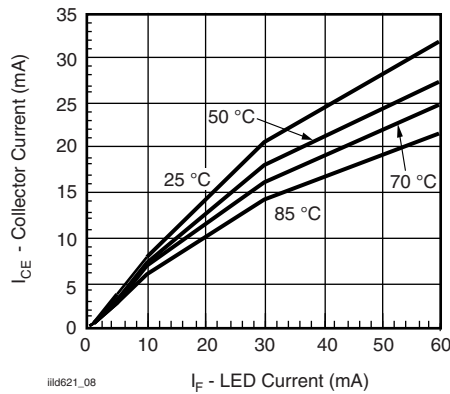

Fig. 8 - Collector Emitter Current vs. Temperature and LED Current

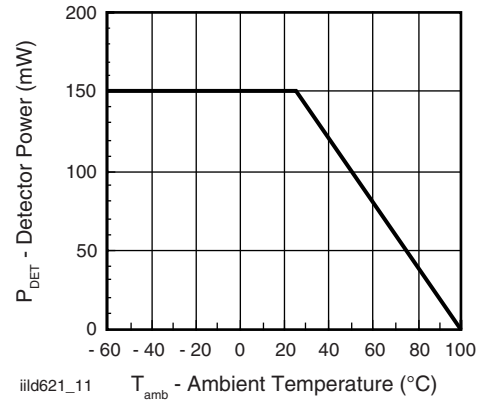

Fig. 11 - Maximum Detector Power Dissipation

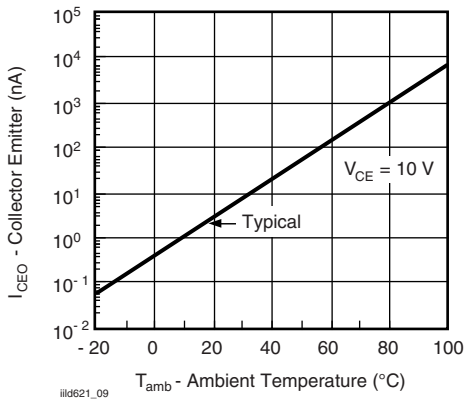

Fig. 9 - Collector Emitter Leakage vs. Temperature

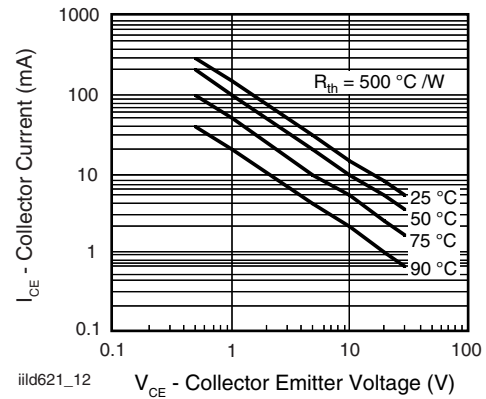

Fig. 12 - Maximum Collector Current vs. Collector Voltage

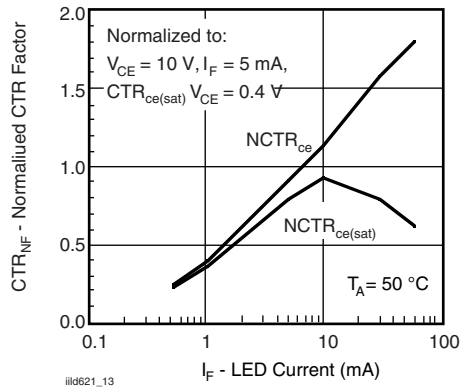

Fig. 13 - Normalization Factor for Non-Saturated and Saturated CTR vs.  $I_F$

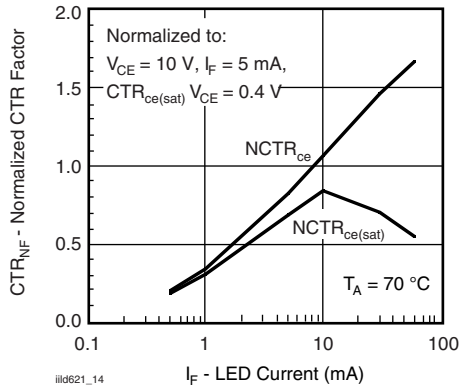

Fig. 14 - Normalization Factor for Non-Saturated and Saturated CTR vs.  $I_F$

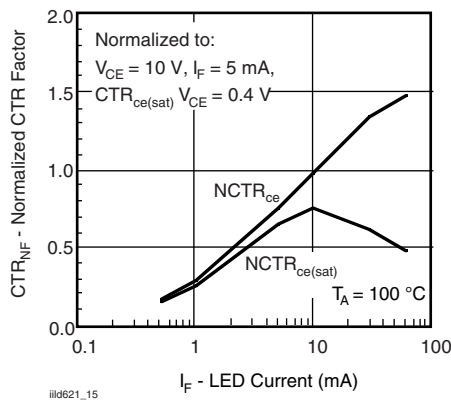
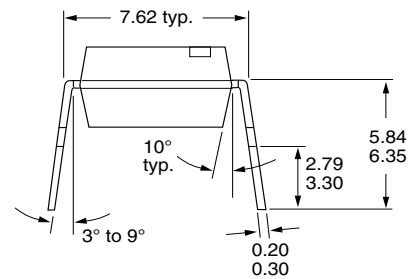
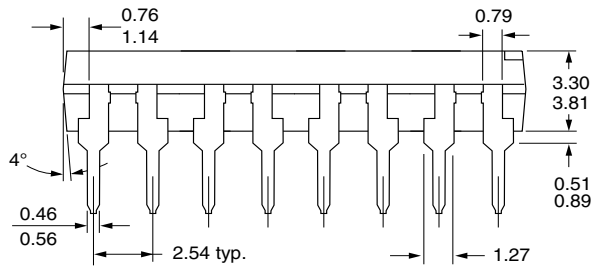
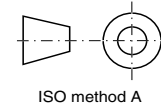
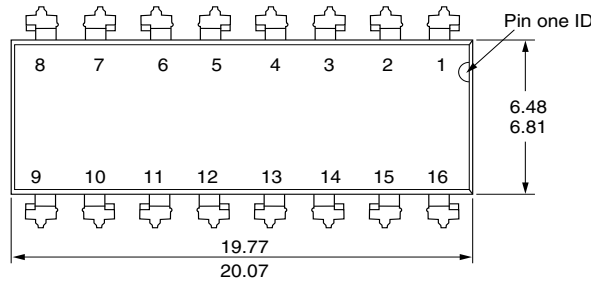
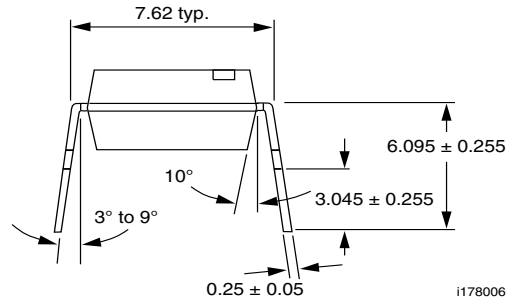
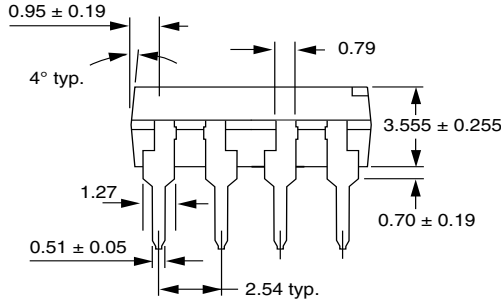
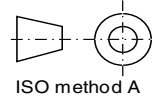
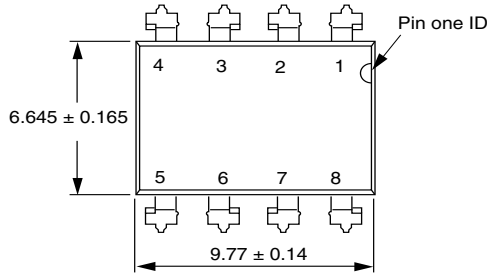

Fig. 15 - Normalization Factor for Non-Saturated and Saturated CTR vs.  $I_F$



## PACKAGE DIMENSIONS in millimeters



i178007

### Option 6

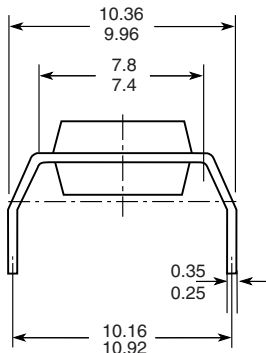

### Option 7

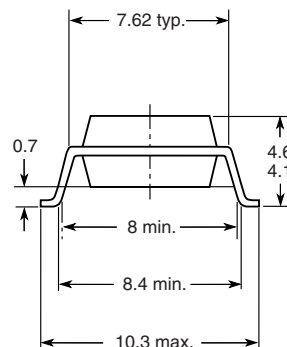

### Option 9

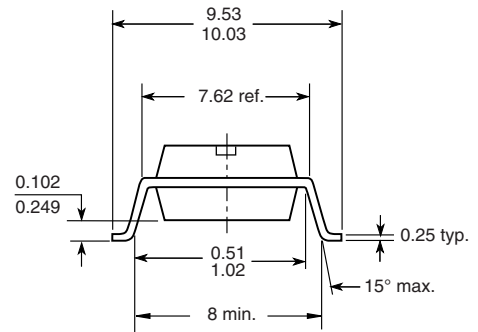

18450



## PACKAGE MARKING

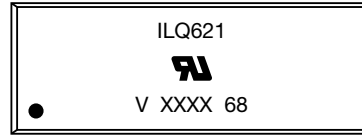
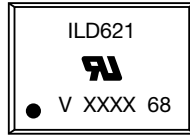

### Note

- XXXX = LMC (lot marking code)





## Disclaimer

ALL PRODUCT, PRODUCT SPECIFICATIONS AND DATA ARE SUBJECT TO CHANGE WITHOUT NOTICE TO IMPROVE RELIABILITY, FUNCTION OR DESIGN OR OTHERWISE.

Vishay Intertechnology, Inc., its affiliates, agents, and employees, and all persons acting on its or their behalf (collectively, "Vishay"), disclaim any and all liability for any errors, inaccuracies or incompleteness contained in any datasheet or in any other disclosure relating to any product.

Vishay makes no warranty, representation or guarantee regarding the suitability of the products for any particular purpose or the continuing production of any product. To the maximum extent permitted by applicable law, Vishay disclaims (i) any and all liability arising out of the application or use of any product, (ii) any and all liability, including without limitation special, consequential or incidental damages, and (iii) any and all implied warranties, including warranties of fitness for particular purpose, non-infringement and merchantability.

Statements regarding the suitability of products for certain types of applications are based on Vishay's knowledge of typical requirements that are often placed on Vishay products in generic applications. Such statements are not binding statements about the suitability of products for a particular application. It is the customer's responsibility to validate that a particular product with the properties described in the product specification is suitable for use in a particular application. Parameters provided in datasheets and / or specifications may vary in different applications and performance may vary over time. All operating parameters, including typical parameters, must be validated for each customer application by the customer's technical experts. Product specifications do not expand or otherwise modify Vishay's terms and conditions of purchase, including but not limited to the warranty expressed therein.

Hyperlinks included in this datasheet may direct users to third-party websites. These links are provided as a convenience and for informational purposes only. Inclusion of these hyperlinks does not constitute an endorsement or an approval by Vishay of any of the products, services or opinions of the corporation, organization or individual associated with the third-party website. Vishay disclaims any and all liability and bears no responsibility for the accuracy, legality or content of the third-party website or for that of subsequent links.

Except as expressly indicated in writing, Vishay products are not designed for use in medical, life-saving, or life-sustaining applications or for any other application in which the failure of the Vishay product could result in personal injury or death. Customers using or selling Vishay products not expressly indicated for use in such applications do so at their own risk. Please contact authorized Vishay personnel to obtain written terms and conditions regarding products designed for such applications.

No license, express or implied, by estoppel or otherwise, to any intellectual property rights is granted by this document or by any conduct of Vishay. Product names and markings noted herein may be trademarks of their respective owners.