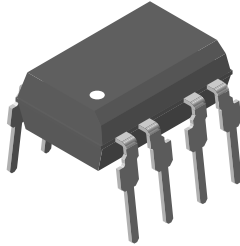
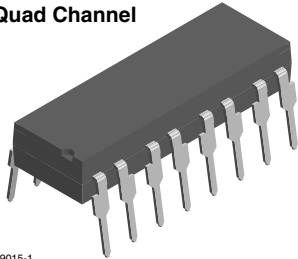
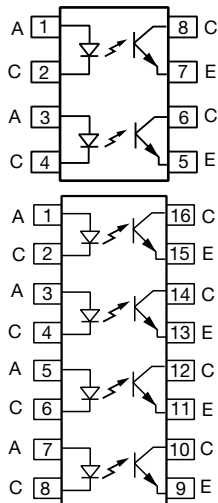

Optocoupler, Phototransistor Output, (Dual, Quad Channel), 110 °C Rated

Dual Channel

Quad Channel

I179015-1

DESCRIPTION

The ILD1615, ILQ1615 are multi-channel 110 °C rated phototransistor optocouplers that use GaAs IRLED emitters and high gain NPN phototransistors. These devices are constructed using over/under leadframe optical coupling and double molded insulation technology resulting a withstand test voltage of 7500 V_{AC PEAK} and a working voltage of 1700 V_{RMS}.

The binned min. / max. and linear CTR characteristics make these devices well suited for DC or AC voltage detection. Eliminating the phototransistor base connection provides added electrical noise immunity from the transients found in many industrial control environments.

Because of guaranteed maximum non-saturated and saturated switching characteristics, the ILD1615, ILQ1615 can be used in medium speed data I/O and control systems. The binned min. / max. CTR specification allow easy worst case interface calculations for both level detection and switching applications. Interfacing with a CMOS logic is enhanced by the guaranteed CTR at I_F = 1.0 mA.

FEATURES

- Operating temperature from -55 °C to +110 °C
- Identical channel to channel footprint
- Dual and quad packages feature:
 - Reduced board space
 - Lower pin and parts count
 - Better channel to channel CTR match
 - Improved common mode rejection
- Isolation test voltage, 5300 V_{RMS}
- Material categorization: for definitions of compliance please see www.vishay.com/doc?99912

RoHS
COMPLIANT

AGENCY APPROVALS

- [UL 1577](#)
- [cUL](#)
- [DIN EN 60747-5-5 \(VDE 0884\)](#), available with option 1
- [FIMKO](#)

LINKS TO ADDITIONAL RESOURCES

[Product Page](#)

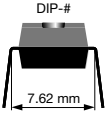

ORDERING INFORMATION		
<div style="display: flex; justify-content: space-around; align-items: center;"> <div style="border: 1px solid black; padding: 2px;">I</div> <div style="border: 1px solid black; padding: 2px;">L</div> <div style="border: 1px solid black; padding: 2px;">x</div> <div style="border: 1px solid black; padding: 2px;">1</div> <div style="border: 1px solid black; padding: 2px;">6</div> <div style="border: 1px solid black; padding: 2px;">1</div> <div style="border: 1px solid black; padding: 2px;">5</div> <div style="border: 1px solid black; padding: 2px;">-</div> <div style="border: 1px solid black; padding: 2px;">4</div> </div> <p style="text-align: center;">PART NUMBER x = D (Dual) or Q (Quad)</p>	CTR BIN	
AGENCY CERTIFIED / PACKAGE	DUAL CHANNEL	QUAD CHANNEL
	CTR (%)	
UL, cUL, FIMKO	160 to 320	160 to 320
DIP-8	ILD1615-4	-
DIP-16	-	ILQ1615-4

ABSOLUTE MAXIMUM RATINGS (T _{amb} = 25 °C, unless otherwise specified)				
PARAMETER	TEST CONDITION	SYMBOL	VALUE	UNIT
INPUT				
Peak reverse voltage		V _R	6.0	V
Forward current		I _F	60	mA
Surge current		I _{FSM}	1.5	A
Power dissipation		P _{diss}	100	mW
Derate linearly from 25 °C			1.0	mW/°C
OUTPUT				
Collector emitter breakdown voltage		BV _{CEO}	70	V
Emitter collector breakdown voltage		BV _{ECO}	7.0	V
Collector current		I _C	50	mA
	t < 1.0 ms	I _C	100	mA
Power dissipation		P _{diss}	150	mW
Derate linearly from 25 °C			1.5	mW/°C
COUPLER				
Storage temperature		T _{stg}	-55 to +150	°C
Operating temperature		T _{amb}	-55 to +110	°C
Soldering temperature ⁽¹⁾	2.0 mm distance from case bottom	T _{slid}	260	°C
Package power dissipation ILD1615			400	mW
Derate linearly from 25 °C			5.33	mW/°C
Package power dissipation ILQ1615			500	mW
Derate linearly from 25 °C			6.67	mW/°C

Notes

- Stresses in excess of the absolute maximum ratings can cause permanent damage to the device. Functional operation of the device is not implied at these or any other conditions in excess of those given in the operational sections of this document. Exposure to absolute maximum ratings for extended periods of the time can adversely affect reliability.

⁽¹⁾ Refer to wave profile for soldering conditions for through hole devices



ELECTRICAL CHARACTERISTICS ($T_{amb} = 25\text{ }^{\circ}\text{C}$, unless otherwise specified)						
PARAMETER	TEST CONDITION	SYMBOL	MIN.	TYP.	MAX.	UNIT
INPUT						
Forward voltage	$I_F = 10\text{ mA}$	V_F	1.0	1.15	1.3	V
Breakdown voltage	$I_R = 10\text{ }\mu\text{A}$	V_{BR}	6.0	30	-	V
Reverse current	$V_R = 6.0\text{ V}$	I_R	-	0.01	10	μA
Capacitance	$V_R = 0\text{ V}, f = 1.0\text{ MHz}$	C_O	-	25	-	pF
OUTPUT						
Collector emitter capacitance	$V_{CE} = 5.0\text{ V}, f = 1.0\text{ MHz}$	C_{CE}	-	6.8	-	pF
Collector emitter leakage current	$V_{CE} = 10\text{ V}$	I_{CEO}	-	5.0	100	nA
Collector emitter breakdown voltage	$I_{CE} = 0.5\text{ mA}$	BV_{CEO}	70	-	-	V
Emitter collector breakdown voltage	$I_E = 0.1\text{ mA}$	BV_{ECO}	7.0	-	-	V
PACKAGE TRANSFER CHARACTERISTICS						
Channel/channel CTR match	$I_F = 10\text{ mA}, V_{CE} = 5.0\text{ V}$	CTR _X /CTR _Y	1 to 1	-	2 to 1	
COUPLER						
Capacitance (input to output)	$V_{IO} = 0\text{ V}, f = 1.0\text{ MHz}$	C_{IO}	-	0.8	-	pF
Insulation resistance	$V_{IO} = 500\text{ V}, T_A = 25\text{ }^{\circ}\text{C}$	R_S	10^{12}	10^{14}	-	Ω
Channel to channel isolation			500	-	-	V_{AC}

Note

- Minimum and maximum values are tested requirements. Typical values are characteristics of the device and are the result of engineering evaluations. Typical values are for information only and are not part of the testing requirements.

CURRENT TRANSFER RATIO ($T_{amb} = 25\text{ }^{\circ}\text{C}$, unless otherwise specified)							
PARAMETER	TEST CONDITION	PART	SYMBOL	MIN.	TYP.	MAX.	UNIT
Current transfer ratio (collector emitter saturated)	$I_F = 1.0\text{ mA}, V_{CE} = 0.4\text{ V}$	ILD1615-4	CTR _{CEsat}	-	100	-	%
		ILQ1615-4					
Current transfer ratio (collector emitter)	$I_F = 10\text{ mA}, V_{CE} = 5.0\text{ V}$	ILD1615-4	CTR _{CE}	160	200	320	%
		ILQ1615-4					
	$I_F = 1.0\text{ mA}, V_{CE} = 5.0\text{ V}$	ILD1615-4	CTR _{CE}	56	90	-	%
	ILQ1615-4						

SWITCHING CHARACTERISTICS ($T_{amb} = 25\text{ }^{\circ}\text{C}$, unless otherwise specified)							
PARAMETER	TEST CONDITION	SYMBOL	MIN.	TYP.	MAX.	UNIT	
NON-SATURATED							
Turn-on time	$I_F = 10\text{ mA}, V_{CC} = 5.0\text{ V}, R_L = 75\text{ }\Omega, 50\text{ }\%$ of V_{PP}	t_{on}	-	3.0	-	μs	
Rise time	$I_F = 10\text{ mA}, V_{CC} = 5.0\text{ V}, R_L = 75\text{ }\Omega, 50\text{ }\%$ of V_{PP}	t_r	-	2.0	-	μs	
Turn-off time	$I_F = 10\text{ mA}, V_{CC} = 5.0\text{ V}, R_L = 75\text{ }\Omega, 50\text{ }\%$ of V_{PP}	t_{off}	-	2.3	-	μs	
Fall time	$I_F = 10\text{ mA}, V_{CC} = 5.0\text{ V}, R_L = 75\text{ }\Omega, 50\text{ }\%$ of V_{PP}	t_f	-	2.0	-	μs	
Propagation H to L	$I_F = 10\text{ mA}, V_{CC} = 5.0\text{ V}, R_L = 75\text{ }\Omega, 50\text{ }\%$ of V_{PP}	t_{PHL}	-	1.1	-	μs	
Propagation L to H	$I_F = 10\text{ mA}, V_{CC} = 5.0\text{ V}, R_L = 75\text{ }\Omega, 50\text{ }\%$ of V_{PP}	t_{PLH}	-	2.5	-	μs	
SATURATED							
Turn-on time	$I_F = 5.0\text{ mA}, V_{CC} = 5.0\text{ V}, R_L = 1.0\text{ k}\Omega, V_{HT} = 1.5\text{ V}$	t_{on}	-	6.0	-	μs	
Rise time	$I_F = 5.0\text{ mA}, V_{CC} = 5.0\text{ V}, R_L = 1.0\text{ k}\Omega, V_{HT} = 1.5\text{ V}$	t_r	-	4.6	-	μs	
Turn-off time	$I_F = 5.0\text{ mA}, V_{CC} = 5.0\text{ V}, R_L = 1.0\text{ k}\Omega, V_{HT} = 1.5\text{ V}$	t_{off}	-	25	-	μs	
Fall time	$I_F = 5.0\text{ mA}, V_{CC} = 5.0\text{ V}, R_L = 1.0\text{ k}\Omega, V_{HT} = 1.5\text{ V}$	t_f	-	15	-	μs	
Propagation H to L	$I_F = 5.0\text{ mA}, V_{CC} = 5.0\text{ V}, R_L = 1.0\text{ k}\Omega, V_{HT} = 1.5\text{ V}$	t_{PHL}	-	5.4	-	μs	
Propagation L to H	$I_F = 5.0\text{ mA}, V_{CC} = 5.0\text{ V}, R_L = 1.0\text{ k}\Omega, V_{HT} = 1.5\text{ V}$	t_{PLH}	-	7.4	-	μs	



COMMON MODE TRANSIENT IMMUNITY ($T_{amb} = 25\text{ }^{\circ}\text{C}$, unless otherwise specified)						
PARAMETER	TEST CONDITION	SYMBOL	MIN.	TYP.	MAX.	UNIT
Common mode rejection output high	$V_{CM} = 50\text{ V}_{P-P}$, $R_L = 1.0\text{ k}\Omega$, $I_F = 0\text{ mA}$	CM_H	-	5000	-	$\text{V}/\mu\text{s}$
Common mode rejection output low	$V_{CM} = 50\text{ V}_{P-P}$, $R_L = 1.0\text{ k}\Omega$, $I_F = 10\text{ mA}$	CM_L	-	5000	-	$\text{V}/\mu\text{s}$
Common mode coupling capacitance		C_{CM}	-	0.01	-	pF

SAFETY AND INSULATION RATINGS				
PARAMETER	TEST CONDITION	SYMBOL	VALUE	UNIT
Climatic classification	According to IEC 68 part 1		55 / 110 / 21	
Comparative tracking index		CTI	175	
Maximum rated withstanding isolation voltage	$t = 1\text{ min}$	V_{ISO}	4420	V_{RMS}
Maximum transient isolation voltage		V_{IOTM}	10 000	V_{peak}
Maximum repetitive peak isolation voltage		V_{IORM}	890	V_{peak}
Isolation resistance	$V_{IO} = 500\text{ V}$, $T_{amb} = 25\text{ }^{\circ}\text{C}$	R_{IO}	$\geq 10^{12}$	Ω
	$V_{IO} = 500\text{ V}$, $T_{amb} = 100\text{ }^{\circ}\text{C}$	R_{IO}	$\geq 10^{11}$	Ω
Output safety power		P_{SO}	400	mW
Input safety current		I_{SI}	275	mA
Safety temperature		T_S	175	$^{\circ}\text{C}$
Creepage distance			≥ 7	mm
Clearance distance			≥ 7	mm
Insulation thickness		DTI	≥ 0.4	mm

Note

- As per IEC 60747-5-5, § 7.4.3.8.2, this optocoupler is suitable for “safe electrical insulation” only within the safety ratings. Compliance with the safety ratings shall be ensured by means of protective circuits.

TYPICAL CHARACTERISTICS ($T_{amb} = 25\text{ }^{\circ}\text{C}$, unless otherwise specified)

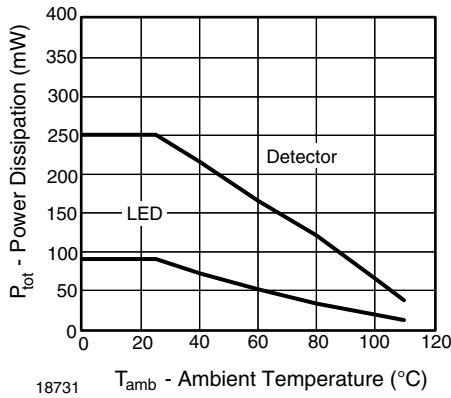

Fig. 1 - Permissible Power Dissipation vs. Temperature Non-Saturation Operation

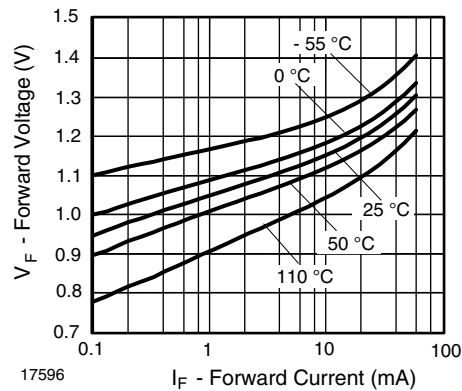

Fig. 2 - Forward Voltage vs. Forward Current

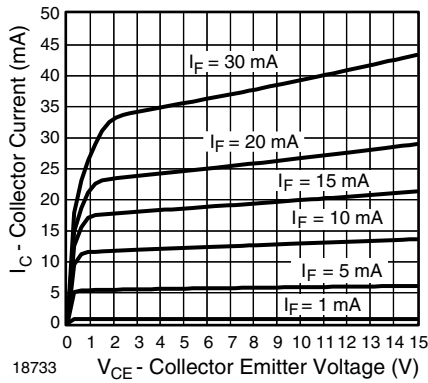

Fig. 3 - Collector Current vs. Collector Emitter Voltage

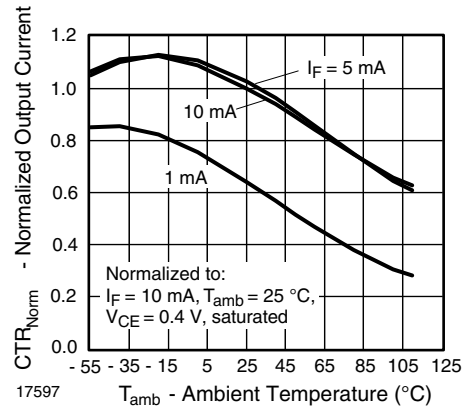

Fig. 6 - Normalized Current Transfer Ratio vs. Ambient Temperature

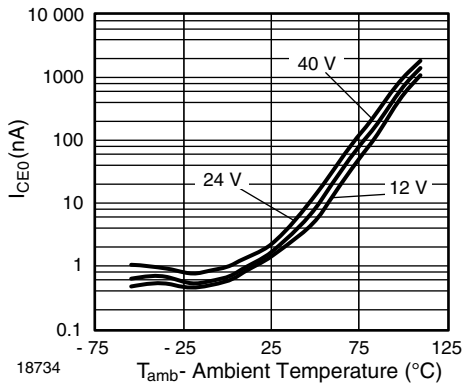

Fig. 4 - Collector to Emitter Dark Current vs. Ambient Temperature

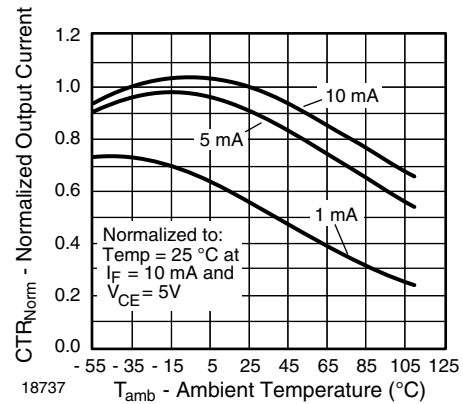

Fig. 7 - Normalized CTR vs. Temperature

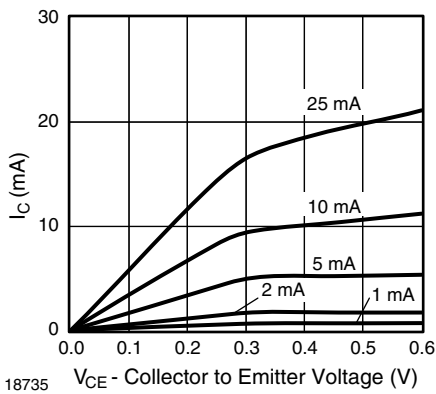

Fig. 5 - Normalized Current vs. Collector Emitter Saturation Voltage

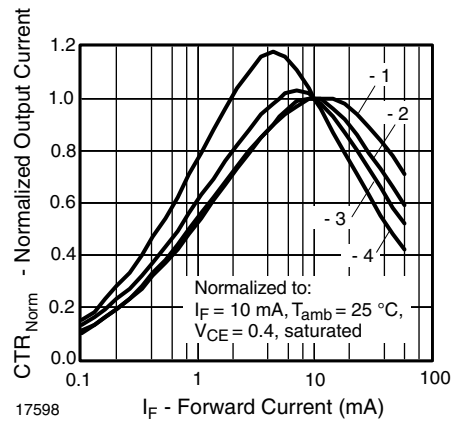

Fig. 8 - Normalized CTR vs. Forward Current

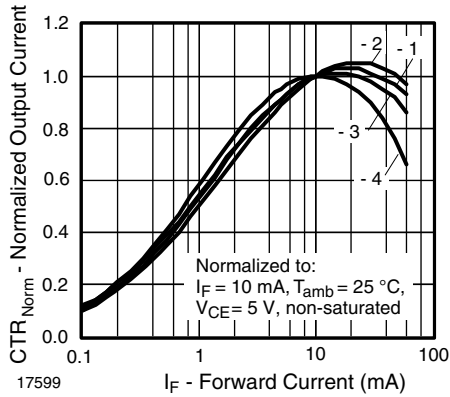

Fig. 9 - Normalized CTR vs. Forward Current

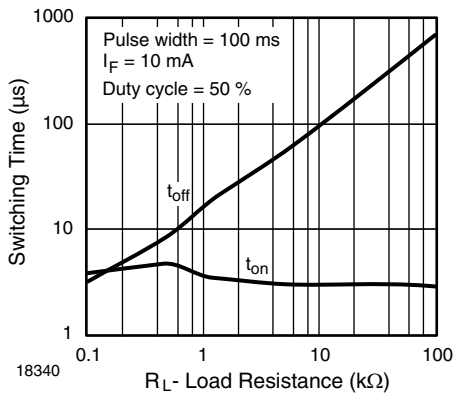

Fig. 10 - Forward Resistance vs. Forward Current

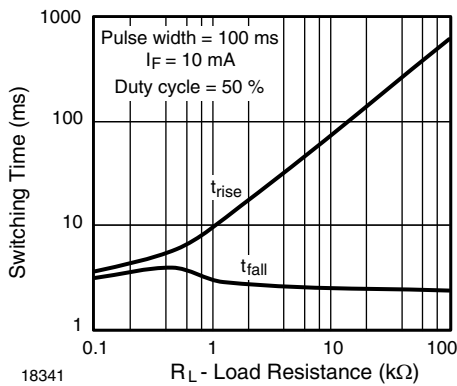
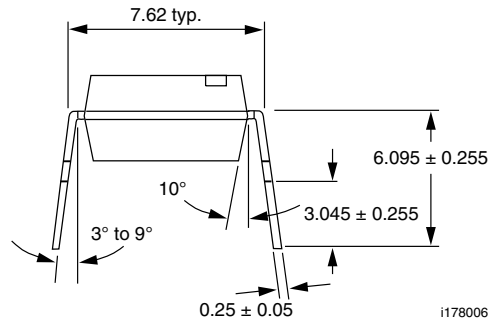
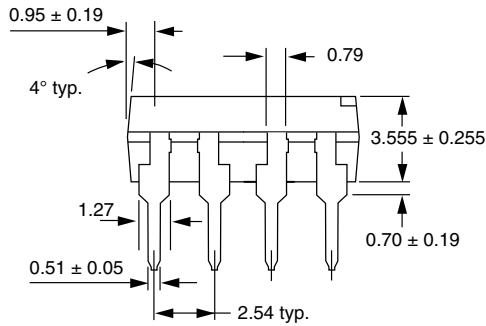
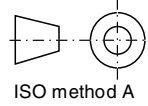
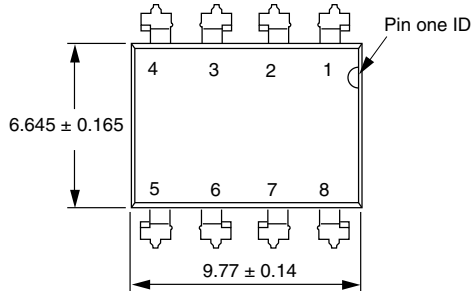

Fig. 11 - Forward Resistance vs. Forward Current



PACKAGE DIMENSIONS in millimeters



i178006

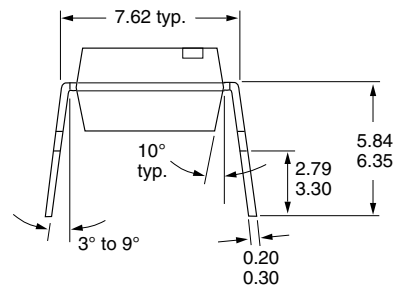
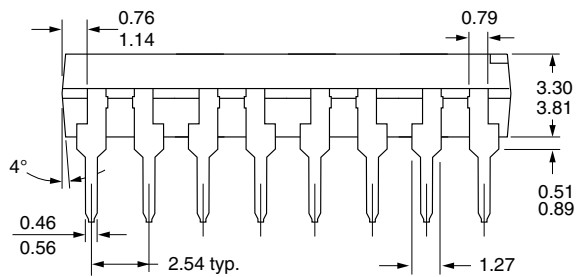
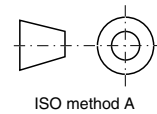
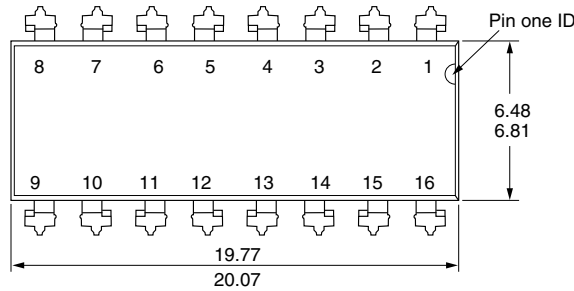

i178007

PACKAGE MARKING

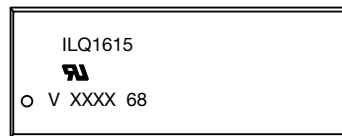
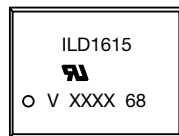

Note

- XXXX = LMC (lot marking code)



Disclaimer

ALL PRODUCT, PRODUCT SPECIFICATIONS AND DATA ARE SUBJECT TO CHANGE WITHOUT NOTICE TO IMPROVE RELIABILITY, FUNCTION OR DESIGN OR OTHERWISE.

Vishay Intertechnology, Inc., its affiliates, agents, and employees, and all persons acting on its or their behalf (collectively, "Vishay"), disclaim any and all liability for any errors, inaccuracies or incompleteness contained in any datasheet or in any other disclosure relating to any product.

Vishay makes no warranty, representation or guarantee regarding the suitability of the products for any particular purpose or the continuing production of any product. To the maximum extent permitted by applicable law, Vishay disclaims (i) any and all liability arising out of the application or use of any product, (ii) any and all liability, including without limitation special, consequential or incidental damages, and (iii) any and all implied warranties, including warranties of fitness for particular purpose, non-infringement and merchantability.

Statements regarding the suitability of products for certain types of applications are based on Vishay's knowledge of typical requirements that are often placed on Vishay products in generic applications. Such statements are not binding statements about the suitability of products for a particular application. It is the customer's responsibility to validate that a particular product with the properties described in the product specification is suitable for use in a particular application. Parameters provided in datasheets and / or specifications may vary in different applications and performance may vary over time. All operating parameters, including typical parameters, must be validated for each customer application by the customer's technical experts. Product specifications do not expand or otherwise modify Vishay's terms and conditions of purchase, including but not limited to the warranty expressed therein.

Hyperlinks included in this datasheet may direct users to third-party websites. These links are provided as a convenience and for informational purposes only. Inclusion of these hyperlinks does not constitute an endorsement or an approval by Vishay of any of the products, services or opinions of the corporation, organization or individual associated with the third-party website. Vishay disclaims any and all liability and bears no responsibility for the accuracy, legality or content of the third-party website or for that of subsequent links.

Except as expressly indicated in writing, Vishay products are not designed for use in medical, life-saving, or life-sustaining applications or for any other application in which the failure of the Vishay product could result in personal injury or death. Customers using or selling Vishay products not expressly indicated for use in such applications do so at their own risk. Please contact authorized Vishay personnel to obtain written terms and conditions regarding products designed for such applications.

No license, express or implied, by estoppel or otherwise, to any intellectual property rights is granted by this document or by any conduct of Vishay. Product names and markings noted herein may be trademarks of their respective owners.