

OPTION A

- NOTES:
- MATERIAL:
HOUSING: POLYESTER(PBT), GLASS FILLED, UL94 V-0,
COLOR: BLACK
TERMINAL: PHOSPHOR BRONZE
 - FINISH:
15 GOLD: 0.38 MICROMETERS/15 MICROINCHES MINIMUM GOLD IN
1.91 MICROMETERS/75 MICROINCHES MINIMUM TIN
OVER NICKEL UNDERPLATE OVERALL
 - TO BE USED WITH 26 AWG STRANDED WIRE WITH (1.35)/.053
DIAMETER MAXIMUM INSULATION
 - SEE TABLE FOR AVAILABLE CIRCUIT SIZES
 - STANDARD PACKAGING PER PK-70873-0001. OPTIONAL PACKAGING
MAY BE AVAILABLE, REQUEST DRAWING PK-70400
 - PARTS STACKABLE END TO END ON (2.54)/.100 CENTERS
 - PRODUCT SPECIFICATION: PS-70400
 - SEE DRAWING SDA-70400-**** (SHEET 3) FOR OPTIONAL
HOUSING DETAILS
 - 4 CIRCUIT SHOWN
 - TO MATE WITH MOLEX 2.54/.100 CENTERLINE HEADERS
 - 2 CIRCUIT ASSEMBLIES SUPPLIED AS GROUPED PAIRS

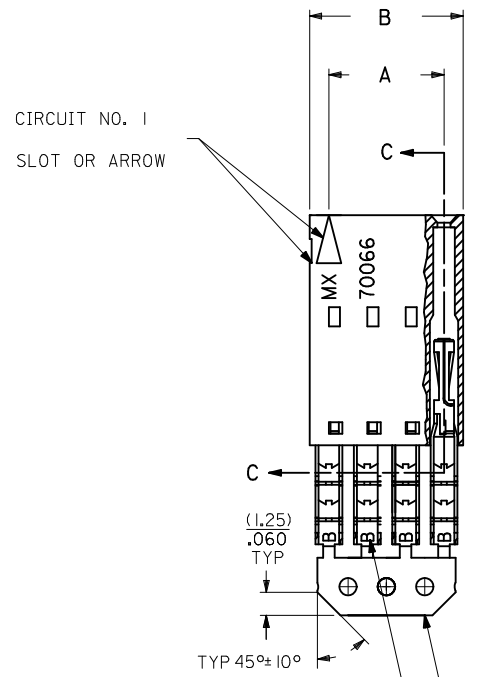

SECTION C-C

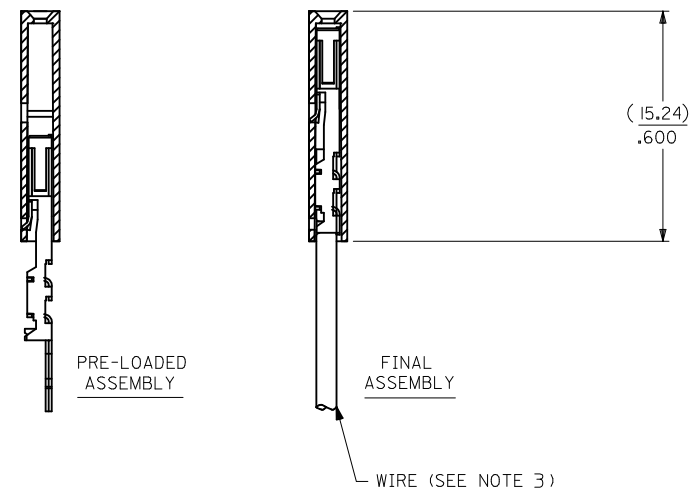

CKT. SIZE	A	B	EDP. NO.
2	(2.54) .100	(5.05) .199	14-56-2023
3	(5.08) .200	(7.59) .299	14-56-2033
4	(7.62) .300	(10.13) .399	14-56-2043
5	(10.16) .400	(12.67) .499	14-56-2053
6	(12.70) .500	(15.21) .599	14-56-2063
7	(15.24) .600	(17.75) .699	14-56-2073
8	(17.78) .700	(20.29) .799	14-56-2083
9	(20.32) .800	(22.83) .899	14-56-2093
10	(22.86) .900	(25.37) .999	14-56-2103
11	(25.40) 1.000	(27.91) 1.099	14-56-2113
12	(27.94) 1.100	(30.45) 1.199	14-56-2123
13	(30.48) 1.200	(32.99) 1.299	14-56-2133
14	(33.02) 1.300	(35.53) 1.399	14-56-2143
15	(35.56) 1.400	(38.07) 1.499	14-56-2153
16	(38.01) 1.500	(40.61) 1.599	14-56-2163
17	(40.64) 1.600	(43.15) 1.699	14-56-2173
18	(43.18) 1.700	(45.69) 1.799	14-56-2183
19	(45.72) 1.800	(48.23) 1.899	14-56-2193
20	(48.26) 1.900	(50.77) 1.999	14-56-2203
21	(50.80) 2.000	(53.31) 2.099	14-56-2213
22	(53.34) 2.100	(55.85) 2.199	14-56-2223
23	(55.88) 2.200	(58.39) 2.299	14-56-2233
24	(58.42) 2.300	(60.93) 2.399	14-56-2243
25	(60.96) 2.400	(63.47) 2.499	14-56-2253

I.D. SLOT CODE TO WIRE GAUGE CHART	
I.D. SLOT CODE	WIRE GAUGE
B	26 AWG.

PLATING CODE (STRIPE ON CARRIER STRIP)	
PLATING	COLOR
15 GOLD	YELLOW

REMOVE ENG NO. EC NO: UCP2011-110 DRW:MSI BARRA 2010/10/19 CHKD:J MORGAN 2010/10/19 APPR:SMILLER 2010/11/24	QUALITY SYMBOLS ∇=0 ∇=0 ∇=0	GENERAL TOLERANCES (UNLESS SPECIFIED) mm INCH 4 PLACES ± --- ± --- 3 PLACES ± --- ± .010 2 PLACES ± 0.25 ± .014 1 PLACE ± 0.35 ± --- ANGULAR ± 1/2°	DIMENSION STYLE MM/IN DRAWN BY DATE MSI BARRA 2010/10/19 CHECKED BY DATE WAZ 1984/10/09 APPROVED BY DATE SMILLER 2010/11/24	SCALE DESIGN UNITS INCH TITLE ASSEMBLY, SL CONNECTOR SINGLE ROW 2.54/.100 GRID	THIRD ANGLE PROJECTION
		DRAFT WHERE APPLICABLE MUST REMAIN WITHIN DIMENSIONS	MATERIAL NO. SEE TABLE	DOCUMENT NO. SDA-70400-0701-0724	SHEET NO. 1 OF 1
		THIS DRAWING CONTAINS INFORMATION THAT IS PROPRIETARY TO MOLEX INCORPORATED AND SHOULD NOT BE USED WITHOUT WRITTEN PERMISSION			
		MOLEX INCORPORATED			

OPTION A

- NOTES:
- MATERIAL:
HOUSING: POLYESTER(PBT), GLASS FILLED, UL94 V-0,
COLOR: BLACK
TERMINAL: PHOSPHOR BRONZE
 - FINISH:
15 GOLD: 0.38 MICROMETERS/15 MICROINCHES MINIMUM GOLD IN
1.91 MICROMETERS/75 MICROINCHES MINIMUM TIN
OVER NICKEL UNDERPLATE OVERALL
 - TO BE USED WITH 26 AWG STRANDED WIRE WITH (1.35)/.053
DIAMETER MAXIMUM INSULATION
 - SEE TABLE FOR AVAILABLE CIRCUIT SIZES
 - STANDARD PACKAGING PER PK-70873-0001. OPTIONAL PACKAGING
MAY BE AVAILABLE, REQUEST DRAWING PK-70400
 - PARTS STACKABLE END TO END ON (2.54)/.100 CENTERS
 - PRODUCT SPECIFICATION: PS-70400
 - SEE DRAWING SDA-70400-**** (SHEET 3) FOR OPTIONAL
HOUSING DETAILS
 - 4 CIRCUIT SHOWN
 - TO MATE WITH MOLEX 2.54/.100 CENTERLINE HEADERS
 - 2 CIRCUIT ASSEMBLIES SUPPLIED AS GROUPED PAIRS

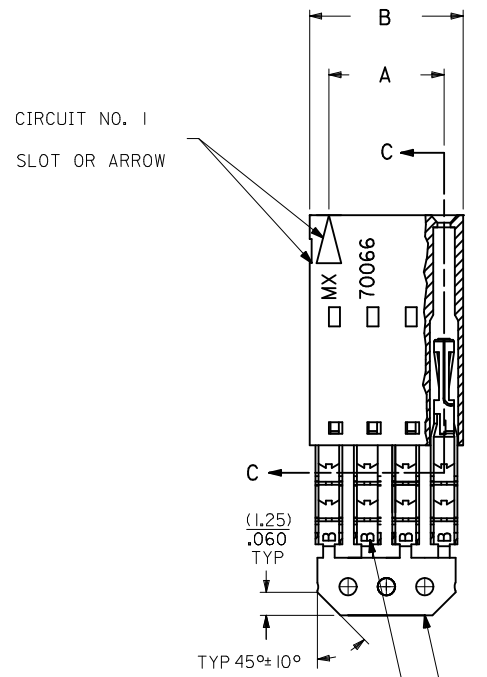
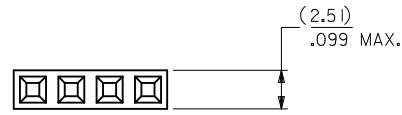

SECTION C-C

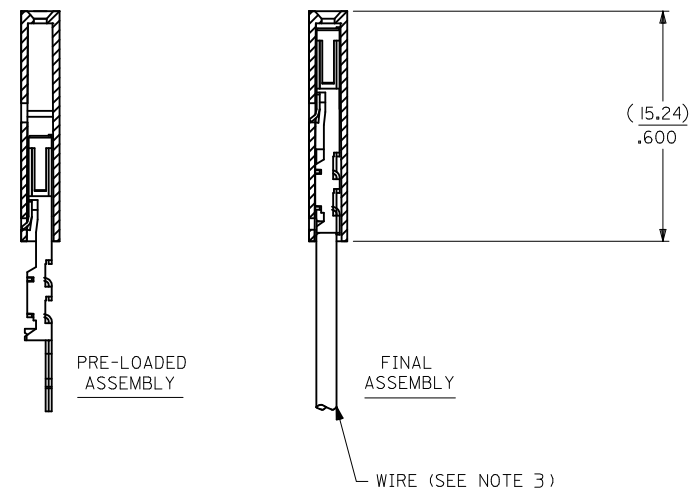

CKT. SIZE	A	B	EDP. NO.
2	(2.54) .100	(5.05) .199	14-56-2023
3	(5.08) .200	(7.59) .299	14-56-2033
4	(7.62) .300	(10.13) .399	14-56-2043
5	(10.16) .400	(12.67) .499	14-56-2053
6	(12.70) .500	(15.21) .599	14-56-2063
7	(15.24) .600	(17.75) .699	14-56-2073
8	(17.78) .700	(20.29) .799	14-56-2083
9	(20.32) .800	(22.83) .899	14-56-2093
10	(22.86) .900	(25.37) .999	14-56-2103
11	(25.40) 1.000	(27.91) 1.099	14-56-2113
12	(27.94) 1.100	(30.45) 1.199	14-56-2123
13	(30.48) 1.200	(32.99) 1.299	14-56-2133
14	(33.02) 1.300	(35.53) 1.399	14-56-2143
15	(35.56) 1.400	(38.07) 1.499	14-56-2153
16	(38.10) 1.500	(40.61) 1.599	14-56-2163
17	(40.64) 1.600	(43.15) 1.699	14-56-2173
18	(43.18) 1.700	(45.69) 1.799	14-56-2183
19	(45.72) 1.800	(48.23) 1.899	14-56-2193
20	(48.26) 1.900	(50.77) 1.999	14-56-2203
21	(50.80) 2.000	(53.31) 2.099	14-56-2213
22	(53.34) 2.100	(55.85) 2.199	14-56-2223
23	(55.88) 2.200	(58.39) 2.299	14-56-2233
24	(58.42) 2.300	(60.93) 2.399	14-56-2243
25	(60.96) 2.400	(63.47) 2.499	14-56-2253

I.D. SLOT CODE TO WIRE GAUGE CHART	
I.D. SLOT CODE	WIRE GAUGE
B	26 AWG.

PLATING CODE (STRIPE ON CARRIER STRIP)	
PLATING	COLOR
15 GOLD	YELLOW

REMOVE ENG NO. EC NO: UCP2011-110 DRW:MSI BARRA 2010/10/19 CHKD:J MORGAN 2010/10/19 APPR:SMILLER 2010/11/24	QUALITY SYMBOLS ∇=0 ∇=0 ∇=0	GENERAL TOLERANCES (UNLESS SPECIFIED) mm INCH 4 PLACES ± --- ± --- 3 PLACES ± --- ± .010 2 PLACES ± 0.25 ± .014 1 PLACE ± 0.35 ± --- ANGULAR ± 1/2°	DIMENSION STYLE MM/IN DRAWN BY DATE MSI BARRA 2010/10/19 CHECKED BY DATE WAZ 1984/10/09 APPROVED BY DATE SMILLER 2010/11/24	SCALE DESIGN UNITS INCH TITLE ASSEMBLY, SL CONNECTOR SINGLE ROW 2.54/.100 GRID	THIRD ANGLE PROJECTION
		DRAFT WHERE APPLICABLE MUST REMAIN WITHIN DIMENSIONS	MATERIAL NO. SEE TABLE	DOCUMENT NO. SDA-70400-0701-0724	SHEET NO. 1 OF 1
		THIS DRAWING CONTAINS INFORMATION THAT IS PROPRIETARY TO MOLEX INCORPORATED AND SHOULD NOT BE USED WITHOUT WRITTEN PERMISSION			
		MOLEX INCORPORATED			